



Weldon Industries
The Instruments Company



Surgical

CATALOGUE

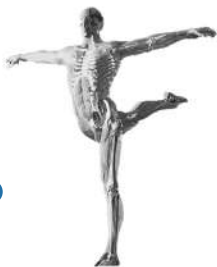

www.weldonind.com



TABLE OF CONTENTS



| CLASS NAME | PAGE NO. |
|---------------------------------------|----------|
| GENERAL INSTRUMENTS | 01 |
| DIAGNOSTICS | 08 |
| VACCINATION AND PUNCTURE | 11 |
| SCISSORS | 19 |
| FORCEPS | 47 |
| ARTERY FORCEPS AND CLAMPS | 60 |
| SUTURE | 94 |
| SUPERCUT SCISSORS AND T/C GOLD PLATED | 106 |
| DRESSING | 137 |
| ORTHOPEDIC INSTRUMENTS | 142 |
| BONE SURGERY | 146 |
| ASEPSIS | 210 |
| RETRACTORS | 213 |
| RHINOLOGY | 261 |
| CARDIOVASCULAR | 292 |
| INTESTINE STOMACH RECTUM | 327 |
| LIVER, GALL BLADDER, KIDNEY | 340 |
| RECTAL AND GENTO-URINARY | 348 |
| TRACHEOTOMY | 351 |
| GYNECOLOGY | 352 |
| NEURO-SURGERY | 383 |
| OTOLOGY | 407 |
| ORAL AND FACIAL SURGERY | 426 |
| TONSILS AND LARYNGO INSTRUMENTS | 438 |
| ANAESTHESIA | 445 |
| ENDOSCOPIC INSTRUMENTS | 447 |
| MICRO SURGERY | 464 |
| OPTHELMIC SURGERY | 470 |



General Instruments Scalpel Handles



#3
WI-080-001



#4
WI-080-002



#7
WI-080-003



#3L
WI-080-004



#4L
WI-080-005

General Instruments Scalpel Handles



1/1

Standard
WF-002-006
No. 3
Solid



1/1

WF-002-006
No. 3
Solid



1/1

WF-002-007
No. 3
Solid



1/1

WF-020-008
No. 3L
Solid Straight

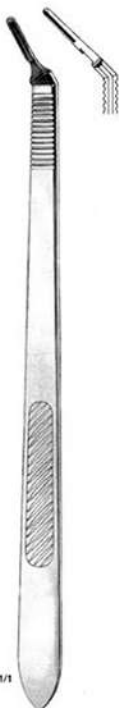

1/1

WF-020-005
No. 3L
Solid Angled

General Instruments Probes



WI-003-001 11.5 cm / 4 1/2"
 WI-003-002 13.0 cm / 5"
 WI-003-003 14.0 cm / 5 1/2"
 WI-003-004 16.0 cm / 6 1/4"
 WI-003-005 18.0 cm / 7"
 WI-003-006 20.0 cm / 8"
 WI-003-007 25.0 cm / 10"

2 mm ø



WI-003-008 11.5 cm / 4 1/2"
 WI-003-009 13.0 cm / 5"
 WI-003-010 14.0 cm / 5 1/2"
 WI-003-011 16.0 cm / 6 1/4"
 WI-003-012 18.0 cm / 7"
 WI-003-013 20.0 cm / 8"

1 mm ø



WI-003-014 14.0 cm / 5 1/2"
 WI-003-015 16.0 cm / 6 1/4"

2 mm ø



WI-003-016 14.0 cm / 5 1/2"
 WI-003-017 16.0 cm / 6 1/4"

2 mm ø



WI-003-018 13.0 cm / 5"
 WI-003-019 14.0 cm / 5 1/2"
 WI-003-020 16.0 cm / 6 1/4"
 WI-003-021 18.0 cm / 7"
 WI-003-022 20.0 cm / 8"
 WI-003-023 25.0 cm / 10"

2 mm ø



WI-003-024 14.0 cm / 5 1/2"
 WI-003-025 18.0 cm / 7"

2 mm ø

General Instruments Probes



Stacke
WI-004-026
10.5 cm / 4 1/8"
1 mm Ø



WI-004-027 14.0 cm / 5 1/2"
WI-004-028 16.0 cm / 6 1/4"
WI-004-029 20.0 cm / 8"



WI-004-030 11.5 cm / 4 1/2"
WI-004-031 13.0 cm / 5"
WI-004-032 14.0 cm / 5 1/2"
WI-004-033 16.0 cm / 6 1/4"
WI-004-034 18.0 cm / 7"
WI-004-035 20.0 cm / 8"



WI-004-036 13.0 cm / 5"
WI-004-037 14.0 cm / 5 1/2"
WI-004-038 16.0 cm / 6 1/4"
WI-004-039 18.0 cm / 7"



1/1
Doyen
WI-004-036
14.0 cm / 5 1/2"



1/1
Nelatou
WI-004-041
16.0 cm / 6 1/4"



Flührer
WI-005-042
10.5 cm / 4 1/8"
1 mm Ø
of tin



Babcock
WI-005-043
40.0 cm / 16"



WI-005-044
Complete with 3 cones



WI-005-045
Probe, Malleable, Only



WI-005-046
Set of cones

General Instruments Vein Probes Set



Nabatoff
WI-008-001
138x100x25 mm

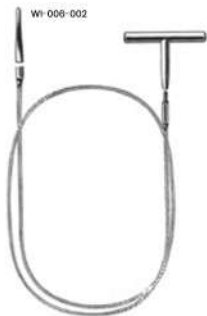

WI-008-002

Olive Ø 3 mm
Olive Ø 6 mm
Olive Ø 9 mm
Olive Ø 12 mm
Olive Ø 15 mm
flexibles

Spare Parts



1/1

WI-008-003
Ø 3 mm



WI-008-004
Ø 6 mm



WI-008-005
Ø 9 mm



WI-008-006
Ø 12 mm



WI-008-007
Ø 15 mm

Olive Ø 3 mm
Olive Ø 6 mm
Olive Ø 9 mm
Olive Ø 12 mm
Olive Ø 15 mm
Handle only
Cable, Flexible, stainless
Metal case

Olive Ø 3 mm
Olive Ø 6 mm
Olive Ø 9 mm
Olive Ø 12 mm
Olive Ø 15 mm
for traction flexible inoxidable

General Instruments Cotton Applicator, Sponge Holder



Fein
WI-007-008
28.0 cm / 11"



WI-007-009
45.0 cm / 17 3/4"



WI-007-010
40.0 cm / 15 3/4"



Playfair
WI-007-010
31.0 cm / 12 1/4"



Rabiner
WI-008-001
23.0 cm / 9"
40 mm Ø



Buck
WI-008-002
18.0 cm / 7"



telescopic

Buck
WI-008-003
18.0 cm / 7"



Special-Mobile
WI-008-004
19.0 cm / 7 1/2"

Diagnostics Percussion Hammers



1/2

Traemner
WI-009-005
24.0 cm / 9 1/2"



1/2

Neuro Duoflex
Mod. Dejerine
WI-009-006
22.0 cm / 8 1/2"



1/2

Dejerine
WI-009-007
20.0 cm / 8"



1/2

Dejerine
WI-009-008
21.0 cm / 8 1/4"



1/2

Taylor
Mod. USA
WI-009-009
20.0 cm / 8"



1/2

Berliner
WI-009-010
20.0 cm / 8"

Diagnostics Sensibility Instruments, Stethoscopes



1/2

Aly
WI-010-011
17.0 cm / 6 3/4"



1/2

Wartenberg
WI-010-012
19.0 cm / 7 1/2"



1/2

Dejerine
WI-009-008
21.0 cm / 8 1/4"



of wood

1/2

Pinard
WI-010-014
18.0 cm / 7"



of aluminium

1/2

Pinard
WI-010-015
15.0 cm / 6"

Vaccination & Puncture Trocars



1/2

Universal
WI-011-001-3

set of 3 pieces

WI-011-001-4

set of 4 pieces



1/2

Standard
11.0 cm / 4 1/4"

WI-011-002 = 3 mm Ø
WI-011-003 = 4 mm Ø
WI-011-004 = 5 mm Ø
WI-011-005 = 6 mm Ø



1/2

Standard
12.0 cm / 4 3/4"

WI-011-006 = 3 mm Ø
WI-011-007 = 4 mm Ø
WI-011-008 = 5 mm Ø
WI-011-009 = 6 mm Ø



1/2

Standard
12.0 cm / 4 3/4"

WI-011-010 = 3 mm Ø
WI-011-011 = 4 mm Ø
WI-011-012 = 5 mm Ø
WI-011-013 = 6 mm Ø

Vaccination & Puncture Trocars



Duke
WI-012-014
11.0 cm / 4 1/2"
5.5 mm Ø



Nelson
WI-012-015-WI-012-017
21.0 cm / 8 1/4"

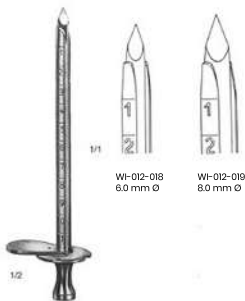

Campbell
WI-012-018
WI-012-019
16.0 cm / 6 1/2"

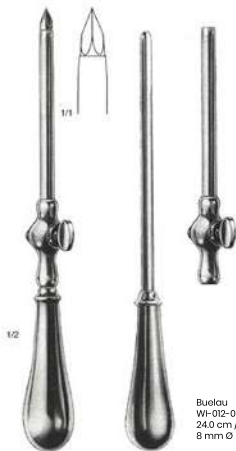

Bulou
WI-012-020
24.0 cm / 9 1/2"
8 mm Ø

Vaccination & Puncture Trocars



Flourant
WI-013-021
23.0 cm / 9"
5 mm Ø

Flourant
WI-013-022
23.0 cm / 9"
5 mm Ø



Ochsner
14.0 cm / 5 1/2"
WI-013-023 = 4 mm Ø
WI-013-024 = 5.5 mm Ø
WI-013-025 = 6.5 mm Ø



Billrot
WI-013-026
24.0 cm / 10"
6 mm Ø

Vaccination & Puncture Suctions Tubes

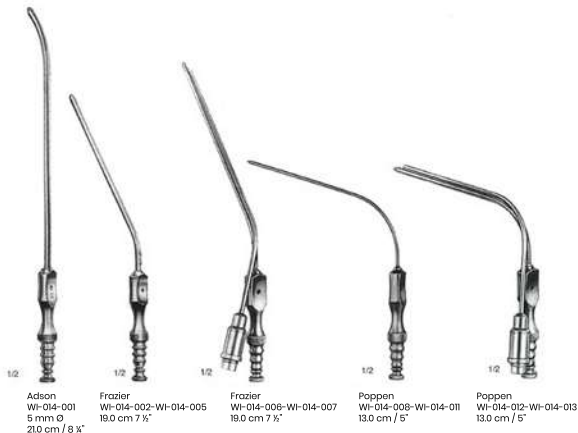

Adson
WI-014-001
5 mm Ø
21.0 cm / 8 1/4"

Frazier
WI-014-002-WI-014-005
19.0 cm 7 1/2"

Frazier
WI-014-006-WI-014-007
19.0 cm 7 1/2"

Poppen
WI-014-008-WI-014-011
13.0 cm / 5"

Poppen
WI-014-012-WI-014-013
13.0 cm / 5"

| Fr | |
|----|------------|
| 6 | WI-014-002 |
| 8 | WI-014-003 |
| 10 | WI-014-004 |
| 12 | WI-014-005 |

| Fr | |
|----|------------|
| 8 | WI-014-006 |
| 10 | WI-014-007 |

| Fr | |
|----|------------|
| 6 | WI-014-008 |
| 8 | WI-014-009 |
| 10 | WI-014-010 |
| 12 | WI-014-011 |

| Fr | |
|----|------------|
| 8 | WI-014-012 |
| 10 | WI-014-013 |



Wullstein
WI-014-014
14.0 cm / 5 1/2"



WI-014-015



WI-014-016



WI-014-017

WI-014-006-WI-014-007 - with Fiber Optics

WI-014-012-WI-014-013 - with Fiber Optics

WI-014-014 - Micro suction tube, complete, consisting of:

WI-014-015 - Micro suction cannula, Ø 0.4 mm
WI-014-016 - Ditto Ø 0.6 mm
WI-014-017 - Ditto Ø 0.8 mm

Vaccination & Puncture Suctions Tubes



Gomel
WI-015-018
15.0 cm / 6"



Hepp/Scheidel
WI-015-019
22.5 cm / 9"



WI-015-020
16.5 cm / 6 1/2"



WI-015-021
6.5 cm / 2 1/2"

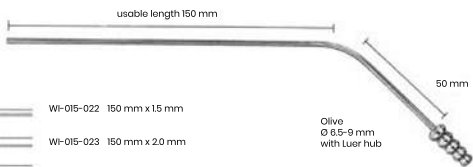

- WI-015-022 150 mm x 1.5 mm
- WI-015-023 150 mm x 2.0 mm
- WI-015-024 150 mm x 2.5 mm
- WI-015-025 150 mm x 3.5 mm

Olive
Ø 8.5-9 mm
with Luer hub

Yasargill
WI-015-022-WI-015-025
11.0 cm / 4 3/8"

- Irrigator for Microsurgery
- Irrigator/Aspirator complete with cannula
- Irrigator/Aspirator only
- Suction and Irrigation, Cannula only

Vaccination & Puncture Suctions Tubes



Yankauer
WI-016-026
27 cm / 11"



Fig. 0
WI-016-029



Fig. 1
WI-016-030



Fig. 2
WI-016-031



Fig. 3
WI-016-032



Yankauer
WI-016-027
27 cm / 11"
Fig. 0.3



WI-016-028

Vaccination & Puncture Suctions Tubes



Vaccination & Puncture Suctions Tubes



6 mm
round

6 mm
Oval



Nuboer
WI-018-040
21.0 cm / 8 1/4"



Nuboer
WI-018-041
21.0 cm / 8 1/4"



Coupland
WI-018-042
17.0 cm / 6 3/4"



WI-018-043
1.5 mm Ø



WI-018-044
2.0 mm Ø



WI-018-045
2.5 mm Ø



WI-018-046
3.5 mm Ø



WI-018-047
1.5 mm Ø



WI-018-048
2.0 mm Ø



WI-018-049
2.5 mm Ø



WI-018-050
3.5 mm Ø

with additional side holes

2.0 mm Ø



WI-018-051
1.5 mm Ø

WI-018-052
2.5 mm Ø

WI-018-053
3.5 mm Ø

Byrd
WI-018-051-WI-018-053
20.0 cm / 8"



Cogswell
WI-018-054
23.0 cm / 9"



BLUNT/BLUNT



WI-019-001
10.5 cm / 4 1/8"



WI-019-002
11.5 cm / 4 1/2"



WI-019-003
13.0 cm / 5"



Standard
WI-019-001-WI-019-008



WI-019-004
14.0 cm / 5 1/2"



WI-019-005
15.5 cm / 6"



WI-019-006
16.5 cm / 6 1/2"



WI-019-007
18.5 cm / 7 1/4"



WI-019-008
20.0 cm / 8"



SHARP/BLUNT

1/1



WI-020-009
10.5 cm / 4 1/8"



WI-020-010
11.5 cm / 4 1/2"



WI-020-011
13.0 cm / 5"



Standard
WI-020-009-WI-020-016

1/1



WI-019-012
14.0 cm / 5 1/2"



WI-020-013
15.5 cm / 6"



WI-020-014
16.5 cm / 6 1/2"

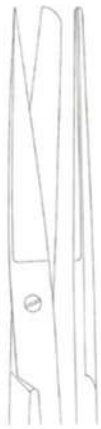

WI-020-015
18.5 cm / 7 1/4"



WI-020-016
20.0 cm / 8"



SHARP/SHARP



Standard
WI-021-017-WI-021-022

1/1

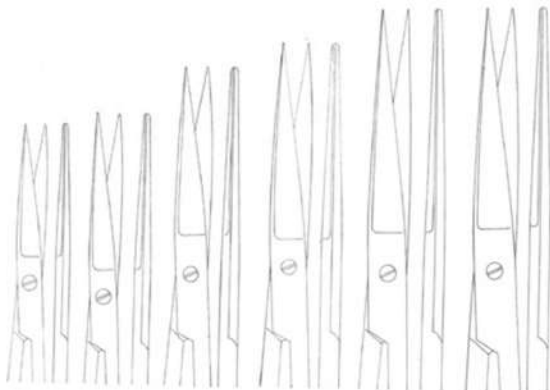

WI-021-017
10.5 cm / 4 1/8"

WI-021-018
11.5 cm / 4 1/2"

WI-021-019
13.0 cm / 5"

WI-021-020
14.0 cm / 5 1/2"

WI-021-021
15.5 cm / 6"

WI-021-022
18.5 cm / 6 1/2"



BLUNT/BLUNT

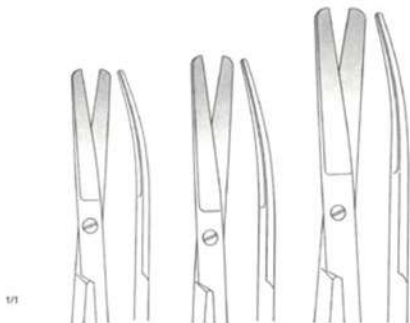

WI-022-023
11.5 cm / 4 1/2"

WI-022-024
13.0 cm / 5"

WI-022-025
14.0 cm / 5 1/2"

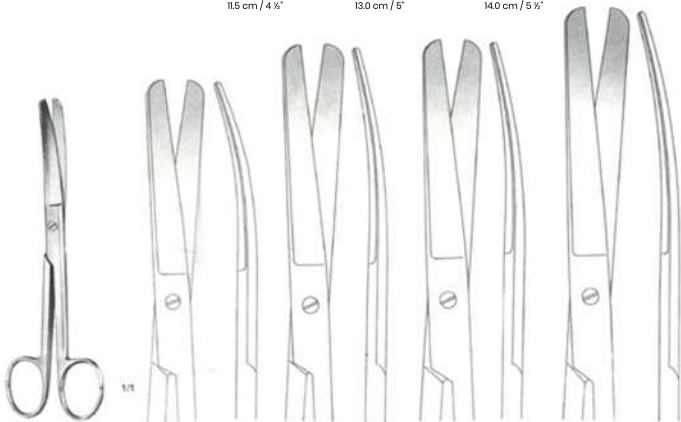

Standard
WI-022-023-WI-022-029

WI-022-026
15.5 cm / 6"

WI-022-027
16.5 cm / 6 1/2"

WI-028-028
18.5 cm / 7 1/2"

WI-022-029
20.0 cm / 8"



SHARP/BLUNT



WI-023-030
11.5 cm / 4 1/2"



WI-023-031
13 cm / 5"



WI-023-032
14.0 cm / 5 1/2"



Standard
WI-023-030-WI-023-036



WI-023-033
15.5 cm / 6"



WI-023-034
16.5 cm / 6 1/2"



WI-023-035
18.5 cm / 6 3/4"

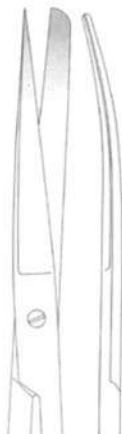

WI-023-036
20.0 cm / 8"



SHARP/SHARP

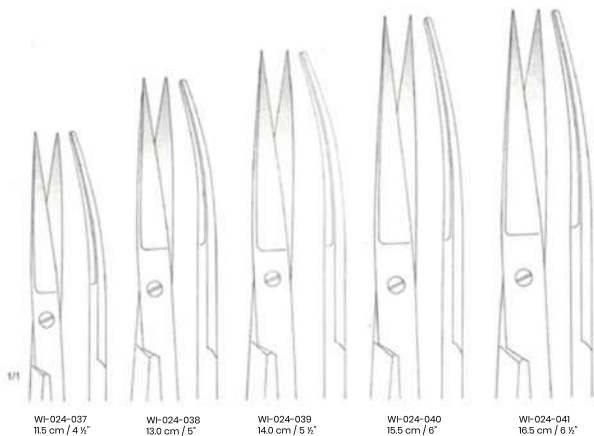

WI-024-037
11.5 cm / 4 1/2"

WI-024-038
13.0 cm / 5"

WI-024-039
14.0 cm / 5 1/2"

WI-024-040
15.5 cm / 6"

WI-024-041
16.5 cm / 6 1/2"

Standard
WI-024-037-WI-024-041



WI-025-042
13.0 cm / 5"



WI-025-043
14.0 cm / 5 1/2"

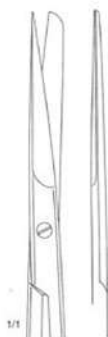

WI-025-044
14.0 cm / 5 1/2"



WI-025-045
14.0 cm / 5 1/2"

WI-024-037-WI-024-041

Incision Scissors

1/2

Deaver
WI-025-045-WI-025-045

General Instruments Operating Scissors



Mayo
WI-026-046-WI-026-053

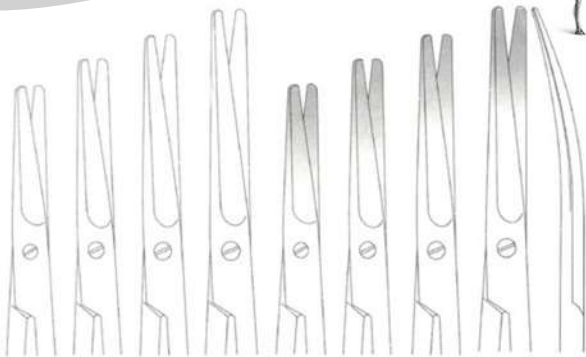

WI-026-046
14.0 cm / 5 1/2"

WI-026-047
15.0 cm / 6"

WI-026-048
17.0 cm / 6 3/4"

WI-026-049
23.0 cm / 9"

WI-026-050
14.0 cm / 5 1/2"

WI-026-051
15.0 cm / 6"

WI-026-052
17.0 cm / 6 3/4"

WI-026-053
23.0 cm / 9"



Mayo-Harrington
WI-026-054-WI-026-056

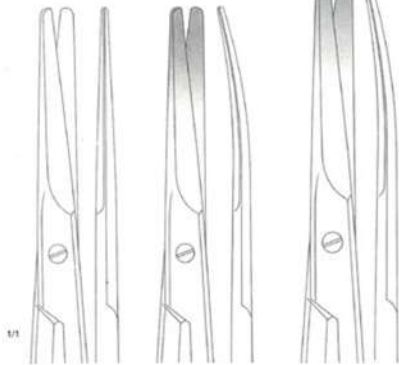

WI-026-054
22.5 cm / 9"

WI-026-055
22.5 cm / 9"

WI-026-058
30.0 cm / 12"

General Instruments Operating Scissors



1/1

WI-027-057
15.0 cm / 6"



WI-027-058
17.0 cm / 6 3/4"



Mayo-Stille
WI-027-057-WI-027-060



1/1

WI-027-059
15.0 cm / 6"



WI-027-060
17.0 cm / 6 3/4"

General Instruments Operating Scissors



1/1



WI-028-061
16.0 cm / 6 1/4"



WI-028-062
19.0 cm / 7 1/2"



WI-028-063
21.0 cm / 8 1/4"



Mayo-Style
WI-028-061-WI-028-066

1/1



WI-028-064
16.0 cm / 6 1/4"



WI-028-065
19.0 cm / 7 1/2"



WI-028-066
21.0 cm / 8 1/4"

General Instruments Gynecological Scissors



Mayo-Noble
WI-029-067-WI-029-088
17.0 cm / 6 3/4"

1/1

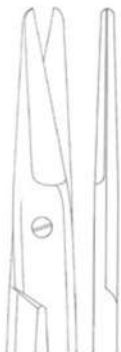

WI-029-067

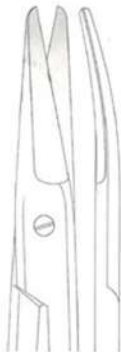

WI-029-088



Wertheim
WI-029-069-WI-029-071

1/1



WI-029-069
14.0 cm / 5 1/2"



WI-029-070
19.5 cm / 7 3/4"



WI-029-071
22.5 cm / 9"

General Instruments Operating Scissors



Kelly
WI-030-072-WI-030-075

1/1



WI-030-072
16.0 cm / 6 1/4"



WI-030-073
18.0 cm / 7"



WI-030-074
16.0 cm / 6 1/4"



WI-030-075
18.0 cm / 7"



Doyen
WI-030-076-WI-030-077

1/1



WI-030-076
17.5 cm / 7"

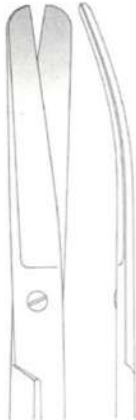

WI-030-077
17.0 cm / 6 3/4"



WI-031-078



WI-031-079



WI-031-080



WI-031-081



Metzenbaum
WI-031-080-WI-031-081
15.0 cm / 6"



Metzenbaum
WI-031-082-WI-031-087
14.0 cm / 5 1/2"



WI-031-082



WI-031-083



WI-031-084



WI-031-085



WI-031-086



WI-031-087

General Instruments Dissecting Scissors



Metzenbaum-Neison
WI-032-088-WI-032-093

1/1



WI-032-088
18.0 cm / 7"



WI-032-089
20.0 cm / 8"



WI-032-090
23.0 cm / 9"



WI-032-091
25.0 cm / 10"



WI-032-092
28.0 cm / 11"



WI-032-093
30.0 cm / 12"



Metzenbaum-Neison
WI-032-094-WI-032-099

1/1



WI-032-094
18.0 cm / 7"



WI-032-095
20.0 cm / 8"



WI-032-096
23.0 cm / 9"



WI-032-097
25.0 cm / 10"



WI-032-098
28.0 cm / 11"



WI-032-099
30.0 cm / 12"



Metzenbaum-Neelson
WI-033-100-WI-033-105

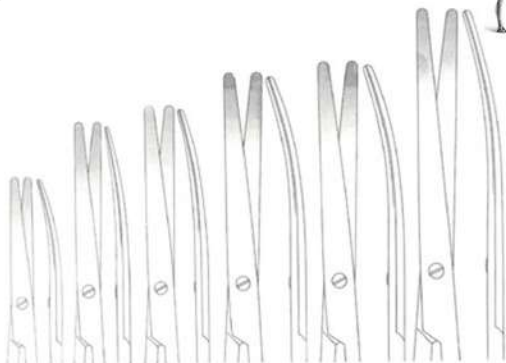

WI-033-100
18.0 cm / 7"

WI-033-101
20.0 cm / 8"

WI-033-102
23.0 cm / 9"

WI-033-103
25.0 cm / 10"

WI-033-104
28.0 cm / 11"

WI-033-105
30.0 cm / 12"



Metzenbaum-Neelson
WI-033-106-WI-033-111

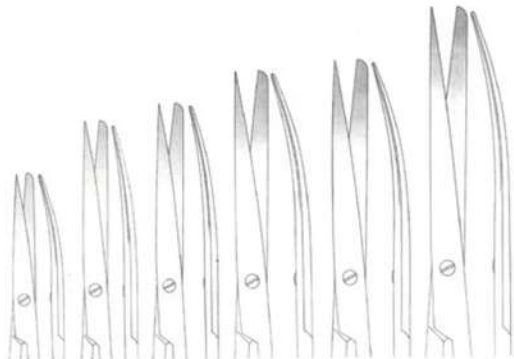

WI-033-106
18.0 cm / 7"

WI-033-107
20.0 cm / 8"

WI-033-108
23.0 cm / 9"

WI-033-109
25.0 cm / 10"

WI-033-110
28.0 cm / 11"

WI-033-111
30.0 cm / 12"



Fomon
WI-034-112
13.5 cm / 5 1/4"

Fine Operating Scissors

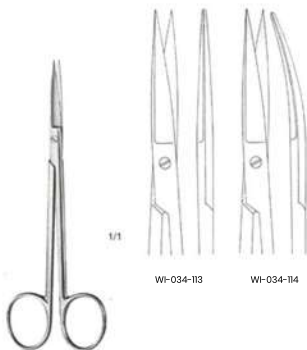

WI-034-113

WI-034-114

Joseph
WI-034-113 - WI-034-114
14.0 cm / 5 1/2"

General Instruments Fine Operating Scissors



Blades, also for undermining

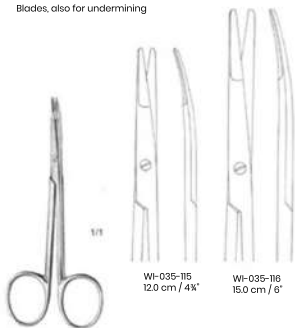

WI-035-115
12.0 cm / 4 3/4"

WI-035-116
15.0 cm / 6"

Kilner
WI-035-115-WI-035-116

outside cutting edge

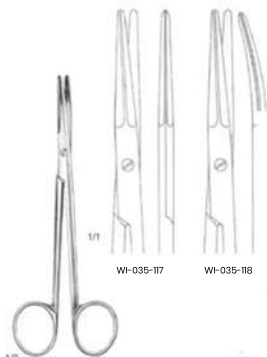

WI-035-117

WI-035-118

WI-035-117-WI-035-118
14.0 cm / 5 1/2"

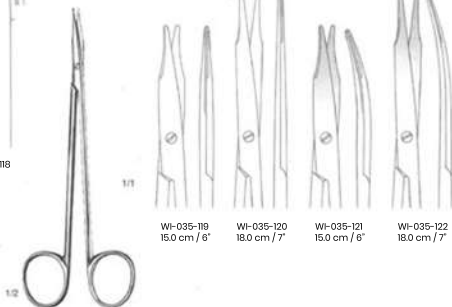

WI-035-119
15.0 cm / 6"

WI-035-120
18.0 cm / 7"

WI-035-121
15.0 cm / 6"

WI-035-122
18.0 cm / 7"

Reynolds
WI-035-119-WI-035-122

General Instruments Thorax Vascular Scissors



Crafoord
WI-036-123
30.0 cm / 12"

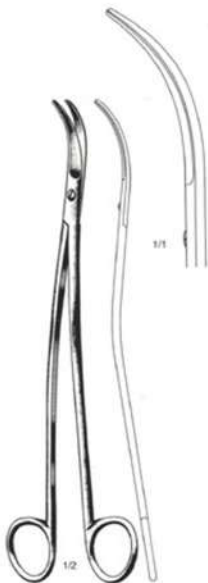

Satinsky
WI-036-124
24.5 cm / 10"

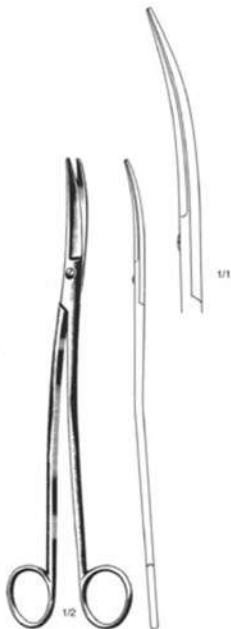

Klinkenbergh-loth
WI-036-125
23.0 cm / 9"

General Instruments

Vascular Scissors



Dietrich
WI-037-126-WI-037-130



WI-037-126
18.0 cm / 7"



WI-037-127
18.0 cm / 7"



WI-037-128
17.5 cm / 7"



WI-037-129
17.0 cm / 6 3/4"



WI-037-130
17.0 cm / 6 3/4"



Dietrich
WI-037-131
17.0 cm / 6 3/4"

General Instruments Thorax Vascular Scissors



Potts-Smith
WI-038-132-WI-038-134
19.0 cm / 7½"



WI-038-132
19.0 cm / 7½"



WI-038-133
19.0 cm / 7½"



WI-038-134
19.0 cm / 7½"



Potts- de Martel
WI-038-135-WI-038-136



WI-038-135
21.0 cm / 8¼"



WI-038-136
24.0 cm / 9½"



Mc Indoe
WI-038-137
19.0 cm / 7½"

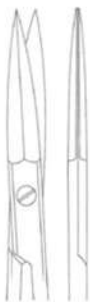

General Instruments Neurosurgical Scissors

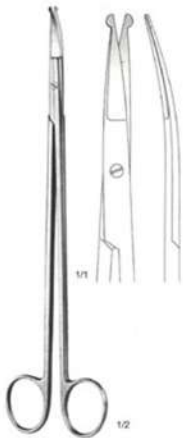

Strully
WI-039-001
22.0 cm / 8½"

• Neurosurgical Scissors



Dandy
WI-039-002
17.0 cm / 6¾"

• Neurosurgical Scissors

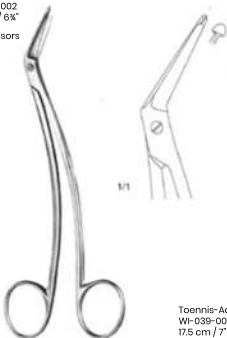

Schmieden-Taylor 1/2
WI-039-003
17.0 cm / 6¾"

• Dura Scissors



Toennis-Adson
WI-039-004
17.5 cm / 7"

• Dissecting Scissors

General Instruments Tonsil & Nasal Scissors



Formon
WI-040-005
15.0 cm / 6"



Cottle
WI-040-006
16.0 cm / 6 1/2"



Heymann
WI-040-007
18.0 cm / 7"

General Instruments Episiotomy Scissors



Waldmann
WI-041-001
18.0 cm / 7"



Braun-Stadler
WI-041-002
14.0 cm / 5 1/2"

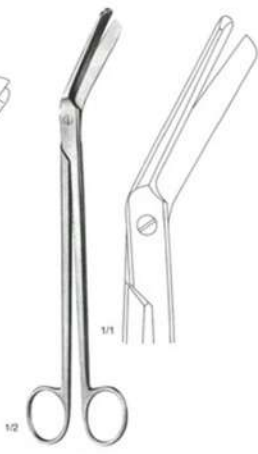

Braun-Stadler
WI-041-003
22.0 cm / 8 3/4"

General Instruments Umbilical Scissors

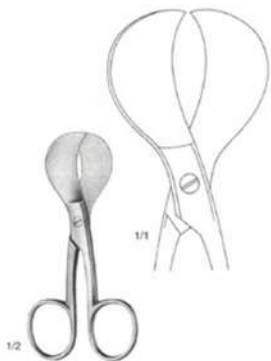

Mod, USA
WI-042-001
10.5 cm / 4 1/4"



Schuhmacher
WI-042-002
15.0 cm / 6"



Busch
WI-042-003
16.0 cm / 6 3/4"

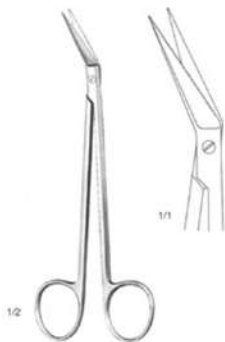

WI-043-001
16.0 cm / 6 1/4"

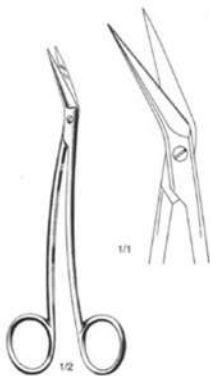

Locklin
WI-043-002
16.0 cm / 6 1/4"



Quinby
WI-043-003
12.5 cm / 5"

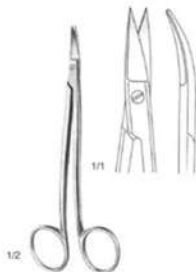

Neumann
WI-043-004
12.0 cm / 4 3/4"

General Instruments Fine Operating Scissors

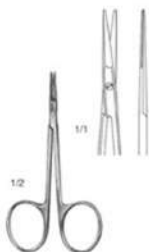

WI-044-001
9.0 cm / 3 1/2"

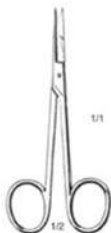

WI-044-002-WI-044-005
11.5 cm / 4 1/2"



WI-044-002



WI-044-003



WI-044-004



WI-044-005



WI-044-006-WI-044-007
12.0 cm / 4 3/4"



WI-044-006



WI-044-007

General Instruments Fine Operating Scissors



WI-045-008

WI-045-009



WI-045-010

WI-045-011



Tenotomy Scissors
WI-045-010-WI-045-011
11.0 cm / 4 1/4"

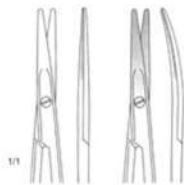

WI-045-012

WI-045-013



Strabismus Scissors
WI-045-012-WI-045-013
11.5 cm / 4 1/2"



Enucleation Scissors
WI-045-014
11.0 cm / 4 1/4"

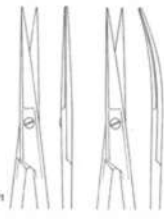

WI-045-015

WI-045-016



Dissecting Scissors
WI-045-015-WI-045-016
11.0 cm / 4 1/4"
(Post mortem)

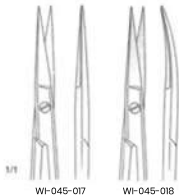

WI-045-017

WI-045-018



Iris Scissors
WI-045-017-WI-045-018
11.0 cm / 4 1/4"

General Instruments Ligature Scissors



Spencer
WI-046-001
9.0 cm / 3½"



Spencer
WI-046-002
13.0 cm / 5"



Littauer
WI-046-003
14.0 cm / 5½"



Universal
WI-046-004
12.0 cm / 4½"

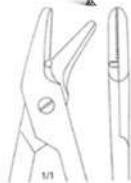

1/1



WI-046-005-WI-046-008

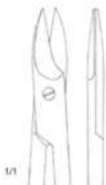

1/1

WI-046-005
10.0 cm / 4"



WI-046-006
10.0 cm / 4"



WI-046-007
12.0 cm / 4¾"



WI-046-008
12.0 cm / 4¾"

1 blade saw edge

1 blade saw edge

General Instruments

Dressing Forceps



1/1



| | | | | | | | | | |
|-----------------------------|-----------------------------|--------------|-----------------------------|-----------------------------|--------------|--------------|---------------|---------------|---------------|
| WI-047-001 | WI-047-002 | WI-047-003 | WI-047-004 | WI-047-005 | WI-047-006 | WI-047-007 | WI-047-008 | WI-047-009 | WI-047-009 |
| 10.5 cm / 4 $\frac{1}{8}$ " | 11.5 cm / 4 $\frac{3}{8}$ " | 13.0 cm / 5" | 14.0 cm / 5 $\frac{1}{2}$ " | 16.0 cm / 6 $\frac{1}{8}$ " | 18.0 cm / 7" | 20.0 cm / 8" | 25.0 cm / 10" | 30.0 cm / 12" | 30.0 cm / 12" |

Standard
WI-047-001-WI-047-009



1/1



| | | | | | | | |
|-----------------------------|--------------|-----------------------------|-----------------------------|--------------|--------------|---------------|---------------|
| WI-047-010 | WI-047-011 | WI-047-012 | WI-047-013 | WI-047-014 | WI-047-015 | WI-047-016 | WI-047-017 |
| 11.0 cm / 4 $\frac{3}{8}$ " | 13.0 cm / 5" | 14.0 cm / 5 $\frac{1}{2}$ " | 16.0 cm / 6 $\frac{1}{8}$ " | 18.0 cm / 7" | 20.0 cm / 8" | 25.0 cm / 10" | 30.0 cm / 12" |

Standard
WI-047-001-WI-047-009

Narrow

General Instruments Dressing Forceps

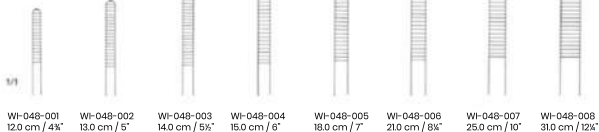

| | | | | | | | |
|---|----------------------------|---|----------------------------|----------------------------|---|-----------------------------|--|
| WI-048-001 12.0 cm / 4 $\frac{1}{2}$ " | WI-048-002 13.0 cm / 5" | WI-048-003 14.0 cm / 5 $\frac{1}{2}$ " | WI-048-004 15.0 cm / 6" | WI-048-005 18.0 cm / 7" | WI-048-006 21.0 cm / 8 $\frac{1}{4}$ " | WI-048-007 25.0 cm / 10" | WI-048-008 31.0 cm / 12 $\frac{1}{4}$ " |
|---|----------------------------|---|----------------------------|----------------------------|---|-----------------------------|--|

Standard
WI-048-001-WI-048-008

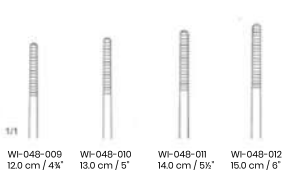

| | | | |
|---|----------------------------|---|----------------------------|
| WI-048-009 12.0 cm / 4 $\frac{1}{2}$ " | WI-048-010 13.0 cm / 5" | WI-048-011 14.0 cm / 5 $\frac{1}{2}$ " | WI-048-012 15.0 cm / 6" |
|---|----------------------------|---|----------------------------|

Standard
WI-048-009-WI-048-012

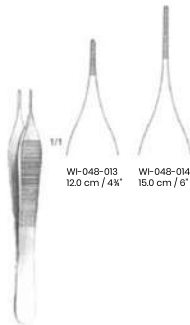

| | |
|---|----------------------------|
| WI-048-013 12.0 cm / 4 $\frac{1}{2}$ " | WI-048-014 15.0 cm / 6" |
|---|----------------------------|

Adson
WI-048-013-WI-048-014



McIndoe
WI-048-014
15.0 cm / 6"

General Instruments Dressing Forceps



WI-049-001
12.5 cm / 5"

WI-049-002
15.0 cm / 6"

Semken
WI-049-001-WI-049-002



Taylor
WI-049-003
17.0 cm / 6 3/4"



Taylor
WI-049-004
17.5 cm / 7"



Taylor
WI-049-005
18.5 cm / 7 1/4"

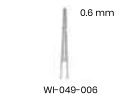

0.8 mm

WI-049-006

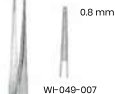

0.8 mm

WI-049-007

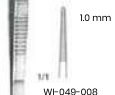

1.0 mm

WI-049-008

WI-049-006-WI-049-008
15.5 cm / 6"
with dissector

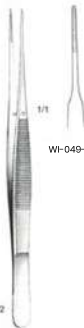

WI-049-009

Gerald
WI-049-009-WI-049-010
18.0 cm / 7"



WI-049-010



WI-049-011



WI-049-012



Cushing
WI-049-011-WI-049-012
17.5 cm / 7"



WI-049-013
18.0 cm / 7"

Potts-Smith
WI-049-013-WI-049-015



WI-049-014
21.0 cm / 8 1/4"



WI-049-015
25.0 cm / 10"

General Instruments Tissue Forceps



WI-050-001
10.5 cm / 4 $\frac{1}{4}$ "

WI-050-002
11.5 cm / 4 $\frac{1}{2}$ "

WI-050-003
13.5 cm / 5"

WI-050-004
14.0 cm / 5 $\frac{1}{2}$ "

WI-050-005
16.0 cm / 6 $\frac{1}{4}$ "

WI-050-006
18.0 cm / 7"

WI-050-007
20.0 cm / 8"

WI-050-008
25.0 cm / 10"

WI-050-009
30.0 cm / 12"

WI-050-001-WI-050-009
1x2 Teeth

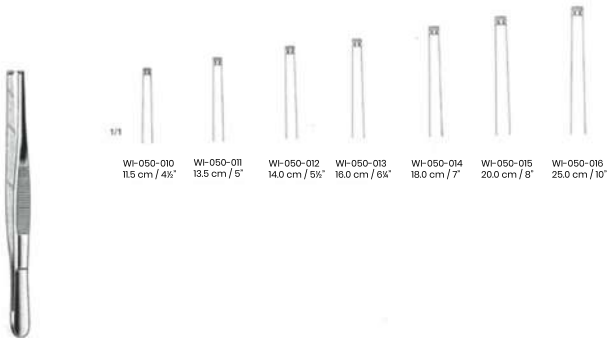

WI-050-010
11.5 cm / 4 $\frac{1}{2}$ "

WI-050-011
13.5 cm / 5"

WI-050-012
14.0 cm / 5 $\frac{1}{2}$ "

WI-050-013
16.0 cm / 6 $\frac{1}{4}$ "

WI-050-014
18.0 cm / 7"

WI-050-015
20.0 cm / 8"

WI-050-016
25.0 cm / 10"

WI-050-010-WI-050-016
2x3 Teeth

General Instruments Tissue Forceps

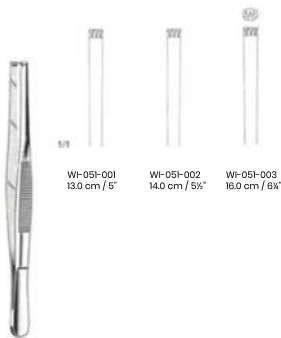

WI-051-001
13.0 cm / 5"

WI-051-002
14.0 cm / 5½"

WI-051-003
16.0 cm / 6¼"

WI-051-001-WI-051-003
3x4 Teeth

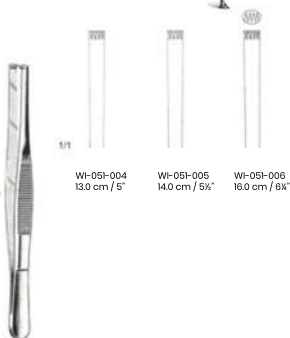

WI-051-004
13.0 cm / 5"

WI-051-005
14.0 cm / 5½"

WI-051-006
16.0 cm / 6¼"

WI-051-004-WI-051-006
4x5 Teeth

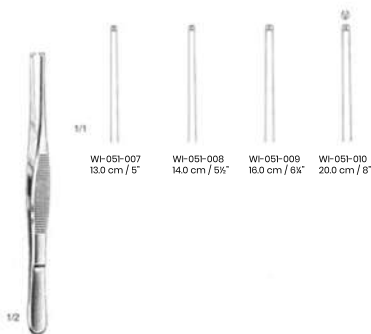

WI-051-007
13.0 cm / 5"

WI-051-008
14.0 cm / 5½"

WI-051-009
16.0 cm / 6¼"

WI-051-010
20.0 cm / 8"

WI-051-007-WI-051-010
1x2 Teeth

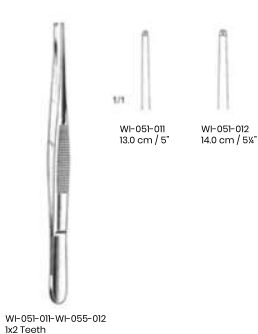

WI-051-011
13.0 cm / 5"

WI-051-012
14.0 cm / 5½"

WI-051-011-WI-051-012
1x2 Teeth

General Instruments Tissue Forceps

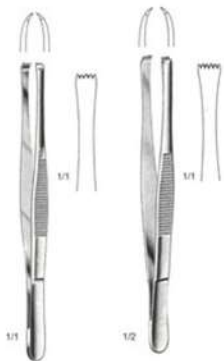

Stone
WI-052-001
15.0 cm / 6"
4x5 Teeth

Stone
WI-052-002
15.0 cm / 6"
5x5 Teeth

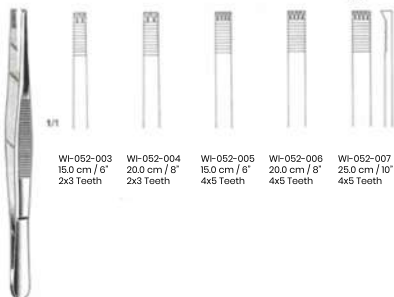

WI-052-003
15.0 cm / 6"
2x3 Teeth

WI-052-004
20.0 cm / 8"
2x3 Teeth

WI-052-005
15.0 cm / 6"
4x5 Teeth

WI-052-006
20.0 cm / 8"
4x5 Teeth

WI-052-007
25.0 cm / 10"
4x5 Teeth

Adlerkreutz
WI-052-003-WI-052-007

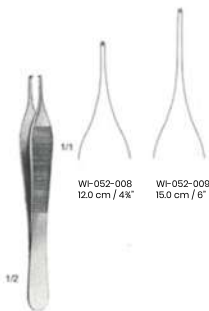

WI-052-008
12.0 cm / 4 3/4"

WI-052-009
15.0 cm / 6"

Adson
WI-052-008-WI-052-009
1x2 Teeth



Gillies
WI-052-010
15.0 cm / 6"
1x2 Teeth

General Instruments Tissue Forceps



WI-053-001
12.5 cm / 4 1/4"



WI-053-002
15.0 cm / 6"



Taylor
WI-053-003
17.5 cm / 7"
1x2 Teeth



Taylor
WI-053-004
17.5 cm / 7"
1x2 Teeth



Taylor
WI-053-005
17.5 cm / 7"
1x2 Teeth

Sernken
WI-053-001-WI-053-002
1x2 Teeth



WI-053-006

WI-053-007

WI-053-008

WI-053-006-WI-053-008
15.0 cm / 6"



WI-053-009



WI-053-010

Gerald
WI-053-009-WI-053-010
17.0 cm / 6 3/4"



Cushing
WI-053-011
17.0 cm / 6 3/4"



Potts-Smith
WI-053-012-WI-053-014



WI-053-012
17.5 cm / 7"



WI-053-013
21.0 cm / 8 1/4"



WI-053-014
25.0 cm / 10"

General Instruments Tissue Forceps



Brophy
WI-054-001
20.0 cm / 8"



Adson-Brown
WI-054-002
20.0 cm / 4 3/4"



Micro-Adson
WI-054-003
12.0 cm / 4 3/4"



Micro-Adson
WI-054-004
12.0 cm / 4 3/4"



Micro-Adson
WI-054-005
11.0 cm / 4 1/2"
Teeth Extremely Delicate



Duval
WI-054-006
14.0 cm / 5 1/2"



Russ, Modell
WI-054-009-WI-054-009



WI-054-007
15.0 cm / 6"



WI-054-008
20.0 cm / 8"



WI-054-009
25.0 cm / 10"



Bonney
WI-055-001-WI-055-002
18.0 cm / 7"



1/1

WI-055-001
1x2 Teeth



WI-055-002
2x3 Teeth



1/2

Maryo-Russ
WI-055-004
23.0 cm / 9"



1/1



Ferrie-Smith
WI-055-003-WI-055-004
18.0 cm / 7"



1/1

WI-055-003
1x2 Teeth



WI-055-004
2x3 Teeth

Grasping Forceps

General Instruments Tissue Forceps



WI-056-001
Ø 3 mm

WI-056-002
Ø 3 mm

Yasargil
WI-056-001-WI-056-002



WI-056-003
Ø 3 mm

WI-056-004
Ø 3 mm

Yasargil
WI-056-003-WI-056-004



WI-056-005
Ø 3 mm

WI-056-006
Ø 3 mm

Heifetz
WI-056-005-WI-056-006

General Instruments Splinter Forceps Cilia Forceps

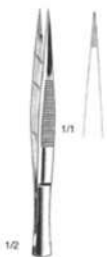

WI-057-001
12.5 cm / 5"



Föllchenfiel
WI-057-002-WI-057-004



WI-057-002
7.5 cm / 3"



WI-057-003
9.0 cm / 3 1/2"



WI-057-004
11.5 cm / 4 1/2" *



Hunter
WI-057-005-WI-057-006
10.5 cm / 4 1/4"



WI-057-005



WI-057-006



WI-057-007



WI-057-008



WI-057-009
12.0 cm / 4 3/4"



WI-057-010
10.0 cm / 4"



WI-057-011
10.0 cm / 4"

Walter-Carmalt
WI-057-007-WI-057-008
10.5 cm / 4 1/4"



Shaaf
WI-058-012
9.0 cm / 3 1/2"



Littauer
WI-058-013
8.5 cm / 3 1/4"



WI-058-014
9.0 cm / 3 1/2"



Douglas
WI-058-015
9.0 cm / 3 1/2"



Douglas
WI-058-016
9.0 cm / 3 1/2"

General Instruments Bulldog Clamps



WI-059-001
6.0 cm / 2½"



WI-059-004
6.0 cm / 2½"



WI-059-002
3.5 cm / 1½"



WI-059-001
3.5 cm / 1½"



WI-059-001
5.0 cm / 2"



WI-059-001
5.0 cm / 2"



Dieffenbach
WI-059-001-WI-059-006



Johns Hopkins
WI-059-007-WI-059-009



WI-059-007
5.0 cm / 2"



WI-059-008
6.5 cm / 2½"



WI-059-009
7.5 cm / 3"



WI-059-010-WI-059-015



| | WI-059-010 | WI-059-011 | WI-059-012 | | WI-059-013 | WI-059-014 | WI-059-015 |
|----------|------------|------------|------------|--|------------|------------|------------|
| Length | 50 mm | 50 mm | 60 mm | | 50 mm | 50 mm | 60 mm |
| Jaws | 8 mm | 12 mm | 20 mm | | 8 mm | 12 mm | 20 mm |
| Weight | 3 gr. | 3 gr. | 3 gr. | | 3 gr. | 3 gr. | 3 gr. |
| Pressure | 50 gr. | 50 gr. | 50 gr. | | 50 gr. | 50 gr. | 50 gr. |

General Instruments Tissue & Organ Holding Forceps



Collin
W-060-001t
14.0 cm / 5 1/2"



Collin
W-060-001
18.5 cm / 6 3/4"

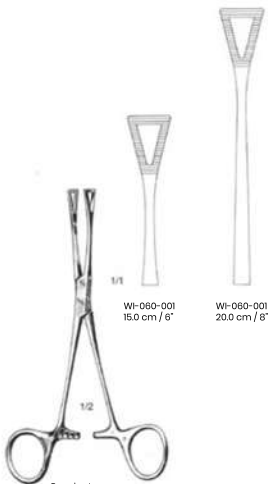

Pennington
W-060-003-W-060-004

W-060-001
15.0 cm / 6"

W-060-001
20.0 cm / 8"



Baby-Mixer
Wf-06f-001 - Wf-06f-002
14.0 cm / 5 1/2"



Wf-06f-001

Wf-06f-002



Hartmann
Wf-06f-003 - Wf-06f-004
10.0 cm / 4"

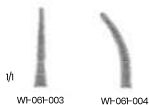

Wf-06f-003

Wf-06f-004

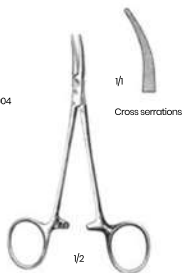

Wf-06f-005
12.0 cm / 4 3/4"

Cross serrations



Halsted-Mosquito
Wf-06f-006 - Wf-06f-013

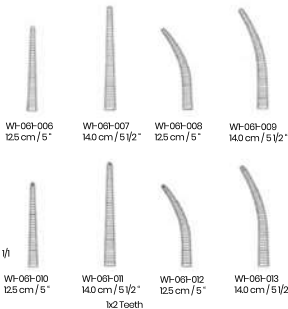

Wf-06f-006
12.5 cm / 5"

Wf-06f-007
14.0 cm / 5 1/2"

Wf-06f-008
12.5 cm / 5"

Wf-06f-009
14.0 cm / 5 1/2"

Wf-06f-010
12.5 cm / 5"

Wf-06f-011
14.0 cm / 5 1/2"

Wf-06f-012
12.5 cm / 5"

Wf-06f-013
14.0 cm / 5 1/2"

lx2 Teeth



Halsted-Mosquito
WF-062-001 - WF-062-008

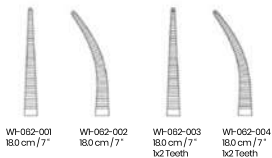

WF-062-001 18.0 cm / 7"
WF-062-002 18.0 cm / 7"
WF-062-003 18.0 cm / 7"
WF-062-004 18.0 cm / 7"

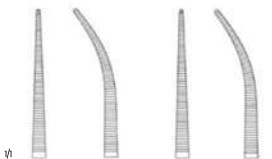

WF-062-005 21.0 cm / 8 1/4"
WF-062-006 21.0 cm / 8 1/4"
WF-062-007 21.0 cm / 8 1/4"
WF-062-008 21.0 cm / 8 1/4"



Micro-Mosquito
WF-062-009 - WF-062-016

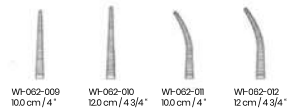

WF-062-009 10.0 cm / 4"
WF-062-010 12.0 cm / 4 3/4"
WF-062-011 10.0 cm / 4"
WF-062-012 12 cm / 4 3/4"

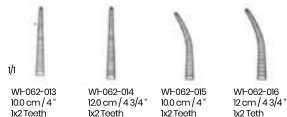

WF-062-013 10.0 cm / 4"
WF-062-014 12.0 cm / 4 3/4"
WF-062-015 10.0 cm / 4"
WF-062-016 12 cm / 4 3/4"



Provideca-Hospital
WI-063-017 - WI-063-018
14.0 cm / 5 1/2"



WI-063-017

WI-063-018

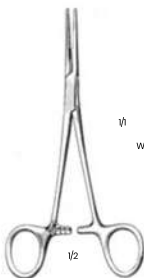

Kelly
WI-063-019 - WI-063-020
14.0 cm / 5 1/2"



WI-063-019

WI-063-020

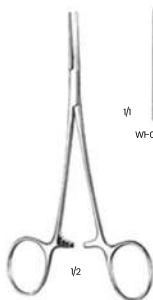

Leriche
WI-063-021 - WI-063-024
15.0 cm / 6"

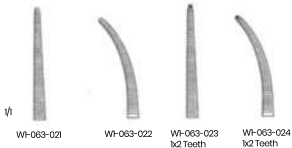

WI-063-021

WI-063-022

WI-063-023

WI-063-024

1x2 Teeth

1x2 Teeth



Rankin-Kelly
WI-064-025 - WI-064-026
16.0 cm / 6 1/4"

1/1



WI-064-025



WI-064-026



Bobby-Overholt
WI-064-027
13.5 cm / 5 1/4"

1/1



WI-064-027



Crile
WI-064-028 - WI-064-031
14.0 cm / 5 1/2"

1/1



WI-064-028



WI-064-029



WI-064-030
1x2 Teeth



WI-064-031
1x2 Teeth

General Instruments Artery Forceps



1/1

WI-065-032



WI-065-033

Rankin-Crile
WI-065-032 - WI-065-033
16.0 cm / 6 1/4"



1/1

WI-065-034



WI-065-035
1x2 Teeth

Lovelace
WI-065-034 - WI-065-035



1/1



Mosquito-Dandy
WI-065-036
12.0 cm / 4 3/4"

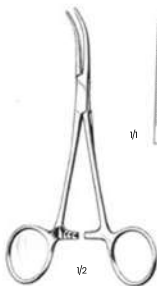

1/1

WI-065-037

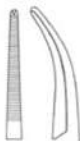
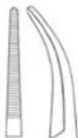

WI-065-038
1x2 Teeth

Dandy
WI-065-037 - WI-065-038



Adson
WI-066-001 - WI-066-002
18.5 cm / 7 1/4"
1x2 Teeth



WI-066-001



WI-066-002



Rochester-Carmalt
WI-066-003 - WI-066-006



WI-066-003
16.0 cm / 6 1/4"



WI-066-004
20.0 cm / 8"



WI-066-005
16.0 cm / 6 1/4"



WI-066-006
20.0 cm / 8"



Pisan
WI-067-007 - WI-067-012
Delicate Pattern

ψ



WI-067-007
13.0 cm / 5"



WI-067-008
14.0 cm / 5 1/2"



WI-067-009
16.0 cm / 6 1/4"



WI-067-010
13.0 cm / 5"



WI-067-011
14.0 cm / 5 1/2"



WI-067-012
16.0 cm / 6 1/4"



Kocher
WI-067-013 - WI-067-018
Delicate Pattern

ψ



WI-067-013
13.0 cm / 5"



WI-067-014
14.0 cm / 5 1/2"



WI-067-015
16.0 cm / 6 1/4"



WI-067-016
13.0 cm / 5"



WI-067-017
14.0 cm / 5 1/2"



WI-067-018
16.0 cm / 6 1/4"

General Instruments Artery Forceps

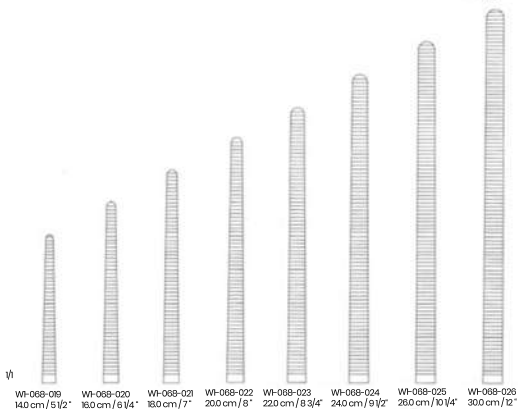

Rochester-Péan
 WI-067-019 - WI-067-034

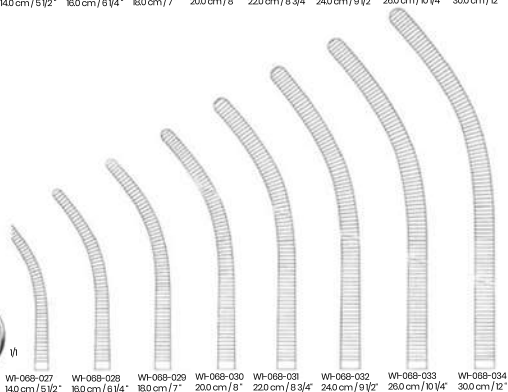

General Instruments Artery Forceps

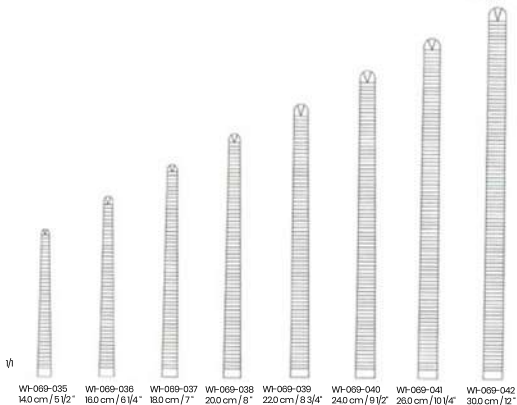

Kocher (Ochsner)
 WI-069-035 - WI-069-050
 1x2 Teeth

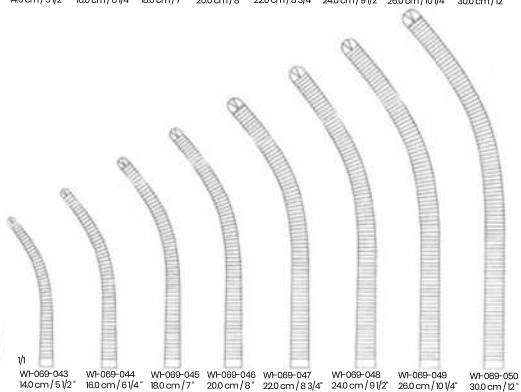

General Instruments Artery Dissecting & Ligature Forceps



Baby-Mixer
WI-070-001
18.0 cm / 7"



Baby-Adson
WI-070-001 - WI-070-003



WI-070-002
14.0 cm / 5 1/2"



WI-070-003
18.0 cm / 7"



Heiss
WI-070-004 - WI-070-006



WI-070-004



WI-070-005



WI-070-006



1/16

General Instruments Artery Dissecting & Ligature Forceps

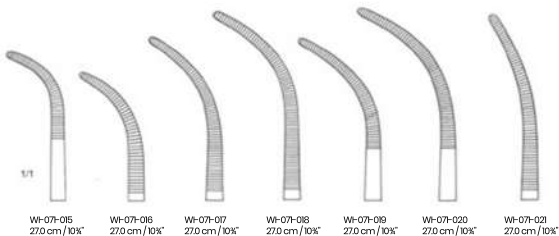
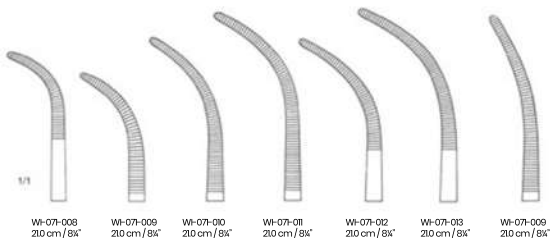

Overholt-Gelssendoerfer
WI-07-008-WI-07-021

General Instruments Dissecting & Ligature Forceps



Mini-Gemini
WF-072-022-WF-072-025



WF-072-022
18.0 cm / 7"



WF-072-023
22.0 cm / 7 3/4"



WF-072-024
25.0 cm / 10"



WF-072-025
28.0 cm / 11"



Mini-Gemini
WF-072-026-WF-072-032



WF-072-026
13.0 cm / 5"



WF-072-027
16.0 cm / 6 1/4"



WF-072-028
18.0 cm / 7"



WF-072-029
20.0 cm / 8"



WF-072-030
23.0 cm / 9"



WF-072-031
25.0 cm / 10"



WF-072-032
28.0 cm / 11"

General Instruments Artery Forceps, Bronchus & Gall Duct Clamps

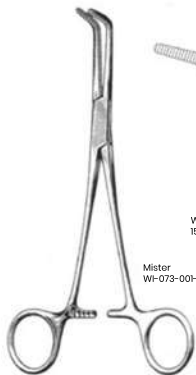

WI-073-001
15.0 cm / 6"

WI-073-000
18.0 cm / 7"

Mister
WI-073-001-WI-073-002



Mister-O'Shaughnessy
WI-073-003
18.0 cm / 7"



Mister
WI-073-004
22.0 cm / 8 1/2"



Mister
WI-073-005
23.0 cm / 9"

General Instruments Artery Forceps, Bronchus & Gall Duct Clamps

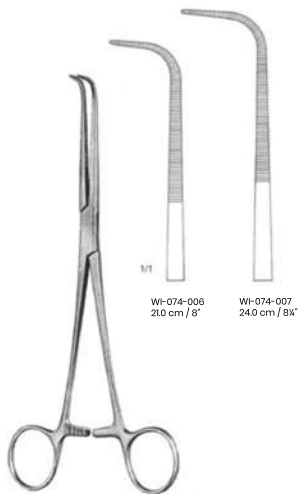

1/1

WI-074-006
21.0 cm / 8"

WI-074-007
24.0 cm / 8 3/4"

1/2

Mixer
WI-074-008-WI-074-010



WI-074-008
22.0 cm / 8 3/4"

WI-074-009
25.0 cm / 10"

WI-074-010
28.0 cm / 11"

General Instruments Artery Forceps, Bronchus & Gall Duct Clamps



McQuigg-Mixter
WI-075-011
22.0 cm / 8 3/4"



Lower
WI-075-012
18.0 cm / 7"



Lahey
WI-075-013-WI-075-014



WI-075-013
19.0 cm / 7 1/2"

WI-075-014
23.0 cm / 9"



Finocchietto
WI-075-015
24.0 cm / 9 1/2"

General Instruments Kidney Pedicle Clamp Forceps



Guyon
WI-076-001-WI-076-002



WI-076-001
23.0 cm / 9"



WI-076-0012
24.0 cm / 9½"

General Instruments Kidney Pedicle Clamp Forceps

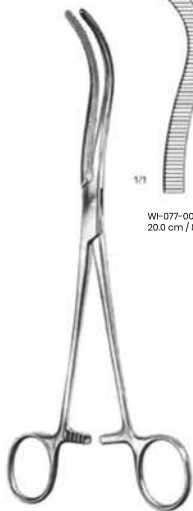

Guyon
WI-077-003-WI-077-005

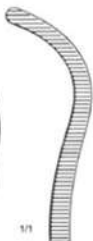

WI-077-003
20.0 cm / 8"



WI-077-004
22.0 cm / 8 3/4"



WI-077-005
24.0 cm / 9 1/2"



Guyon
WI-077-006
23.0 cm / 9"



1/1

General Instruments Artery & Gall Duct Clamps



Desjardins
WI-078-007
21.0 cm / 8 1/4"



Negus
WI-078-008-WI-078-009
19.0 cm / 7 1/2"

General Instruments Clamp-Forceps, Hysterectomy & Vaginal Forceps

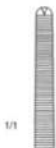

WI-079-001



WI-079-002



WI-079-003
19.5 cm / 7 7/8"



WI-079-004
21.0 cm / 8 1/4"



WI-079-005
23.0 cm / 9"

Phaneuf
WI-079-001-WI-079-002
21.5 cm / 8 1/2"
1x2 Teeth



Heaney
WI-079-003-WI-079-008



WI-079-006
19.5 cm / 7 7/8"



WI-079-007
21.0 cm / 8 1/4"



WI-079-008
23.0 cm / 9"

General Instruments Clamp-Forceps, Hysterectomy & Vaginal Forceps



Werthol-Cullen
WI-080-001
21.5 cm / 8 1/2"

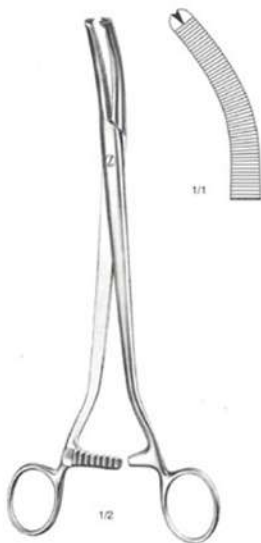

Wertheil
WI-080-002
24.0 cm / 9 1/2"
Extra Strong

General Instruments Clamp-Forceps, Hysterectomy & Vaginal Forceps



Faure
WI-081-003
25.0 cm / 10"



Werheim
WI-081-004
25.0 cm / 10"
heavy pattern



Werheim
WI-081-005
25.0 cm / 10"

General Instruments Clamp-Forceps, Hysterectomy & Vaginal Forceps

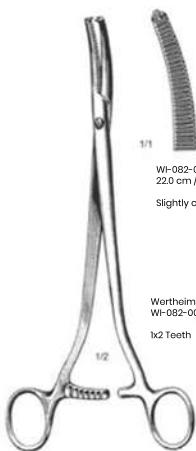

WI-082-006
22.0 cm / 8 3/4"

Slightly curved

WI-082-006
23.0 cm / 8"

More curved

Wertheim
WI-082-006-WI-082-007

1x2 Teeth



WI-082-008
22.0 cm / 8 3/4"

Slightly curved

WI-082-009
23.0 cm / 8"

More curved

Wertheim
WI-082-008-WI-082-009

1x2 Teeth

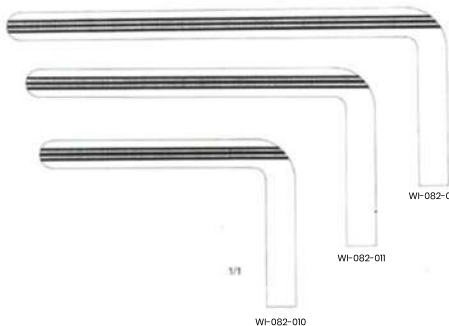

1/1

WI-082-010

WI-082-011

WI-082-012

Wertheim
WI-082-010-WI-082-01012
24.0 cm / 9 1/2"



1/2

General Instruments Towel Forceps



1/2

Schaedel
WI-083-001
9.0 cm / 3½"



1/2

WI-083-002-5.0 cm / 2"
WI-083-003-9.0 cm / 3½"



WI-083-004-11.0 cm / 4½"
WI-083-005-13.0 cm / 5"

Delicate Pattern

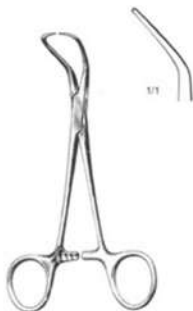

1/1

Backhaus
WI-083-006-11.0 cm / 3½"
WI-083-007-13.0 cm / 4½"
WI-083-008-13.0 cm / 5"
WI-083-009-15.0 cm / 6"



Roeder
WI-083-010-13.0 cm / 5"
WI-083-011-15.0 cm / 6"



1/1

Lorna
WI-083-010-10.0 cm / 4"
WI-083-013-13.0 cm / 5"

General Instruments Tubing Clamps



Standard
WI-084-001-WI-084-003



WI-084-001
15.0 cm / 6"



WI-084-002
18.0 cm / 7"



WI-084-003
20.0 cm / 8"



WI-084-004-WI-084-006

• with safety guard



WI-084-004
15.0 cm / 6"



WI-084-005
18.0 cm / 7"



WI-084-006
20.0 cm / 8"

General Instruments

Artery Forceps



Petit-Point Jacobson Mosquito Forceps
WI-085-001 - 13.0 cm / 5" - Straight
WI-085-002 - 13.0 cm / 5" - Curved

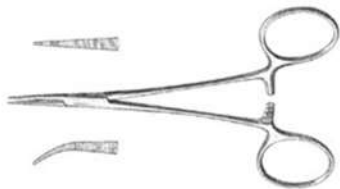

Petit-Point Jacobson Mosquito Forceps
WI-085-003 - 9.8 cm / 3 $\frac{1}{4}$ " - Straight
WI-085-004 - 9.8 cm / 3 $\frac{1}{4}$ " - Curved
WI-085-005 - 9.8 cm / 4 $\frac{1}{4}$ " - Straight
WI-085-006 - 9.8 cm / 4 $\frac{1}{4}$ " - Curved

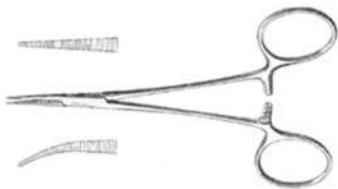

Petit-Point Mosquito Forceps
WI-085-007 - 15.0 cm / 6" - Straight
WI-085-008 - 15.0 cm / 6" - Curved

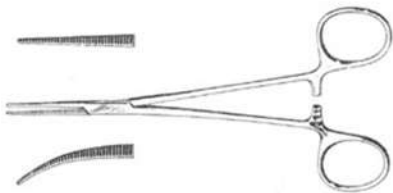

General Instruments

Artery Forceps



Petit-Point Mosquito Forceps
WI-086-009 - 18.1 cm / 7 $\frac{1}{2}$ " - Straight
WI-086-010 - 18.1 cm / 7 $\frac{1}{4}$ " - Curved

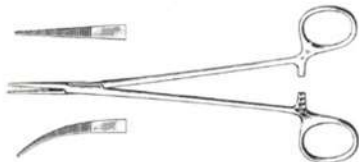

Petit-Point Crile Forceps
WI-086-011 - 14.0 cm / 5 $\frac{1}{2}$ " - Straight
WI-086-012 - 14.0 cm / 5 $\frac{1}{4}$ " - Curved

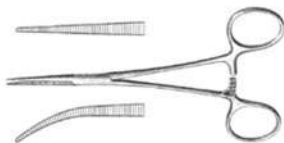

Petit-Point Pean Forceps
WI-086-013 - 14.0 cm / 5 $\frac{1}{2}$ " - Straight
WI-086-014 - 14.0 cm / 5 $\frac{1}{4}$ " - Curved

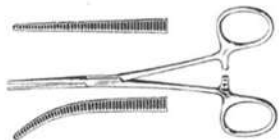

Petit-Point Pean Ochsner Forceps
WI-086-015 - 14.0 cm / 5 $\frac{1}{2}$ " - Straight
WI-086-016 - 14.0 cm / 5 $\frac{1}{4}$ " - Curved

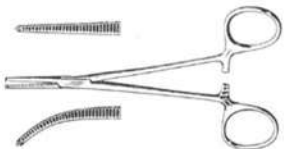

General Instruments Artery Forceps & Scissors



Petit-Point Reynolds Scissors
WI-087-017 - 13.0 cm / 5" - Curved
CARB-EDGE blades,
one blade serrated



Petit-Point Olsen-Hegar Needle Holder
13.0 cm / 5" - delicate

WI-087-018 Serrated
WI-087-019 Smooth

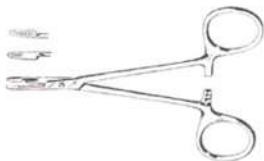

Petit-Point Olsen-Hegar Needle Holder
13.0 cm / 5" - delicate CARB-BITE jaws

WI-087-020 Serrated
WI-087-021 Smooth



Petit-Point Ryder Needle Holder
Imm CARB-BITE jaws, serrated

WI-087-022 13.0 cm / 5"
WI-087-023 15.0 cm / 6"
WI-087-024 18.0 cm / 7"
WI-087-025 23.0 cm / 9"



General Instruments

Artery Forceps



Petit-Point Ryder Needle Holders
Imm CARB-BITE jaws, smooth

WI-088-026 12.7 cm / 5"
WI-088-027 15.0 cm / 6"
WI-088-028 18.0 cm / 7"
WI-088-029 23.0 cm / 9"

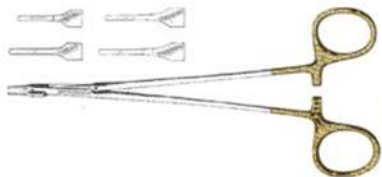

Petit-Point Sarot Needle Holders
Imm CARB-BITE jaws, delicate

WI-088-030 15.0 cm / 6"
WI-088-031 16.8 cm / 6 $\frac{3}{4}$ "

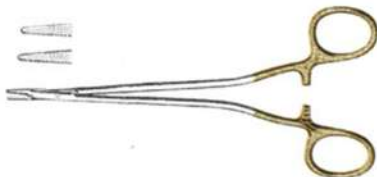

Petit-Point Allis Tissue Holders

WI-088-032 13.3 cm / 5 $\frac{1}{4}$ "
3x4 Teeth

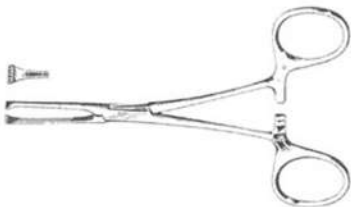

General Instruments

Artery Forceps



Petit-Point Babcock Forceps

WI-089-033 13.3 cm / 5¼" jaws width 6mm
WI-089-034 16.0 cm / 6¼" jaws width 7.5mm

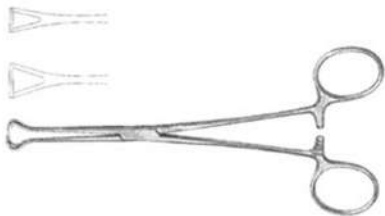

Petit-Point Mixer Forceps

WI-089-035 13.3 cm / 5¼"

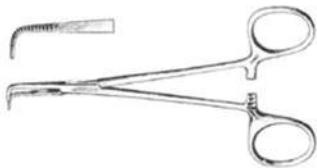

Petit-Point Mixer Forceps

WI-089-038 18.5 cm / 7¼"

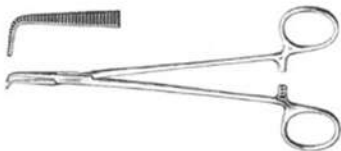

General Instruments Dressing & Cotton Swab Forceps Foreign Body Forceps



Gross-Maier
WI-090-001-WI-090-004

WI-090-001 - 20.0 cm / 8"
WI-090-002 - 25.0 cm / 10"

without ratchet



WI-090-003 - 20.0 cm / 8"
WI-090-004 - 25.0 cm / 10"



Gross-Maier
WI-090-005-WI-090-008

WI-090-005 - 20.0 cm / 8"
WI-090-006 - 25.0 cm / 10"

with ratchet

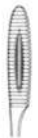

WI-090-007 - 20.0 cm / 8"
WI-090-008 - 25.0 cm / 10"



Gross-Maier
WI-090-009-WI-090-016



WI-090-009 - 20.0 cm / 8"
WI-090-010 - 22.0 cm / 8 1/2"
WI-090-011 - 25.0 cm / 10"
WI-090-012 - 27.0 cm / 10 1/2"



WI-090-013 - 20.0 cm / 8"
WI-090-014 - 22.0 cm / 8 1/2"
WI-090-015 - 25.0 cm / 10"
WI-090-016 - 27.0 cm / 10 1/2"

General Instruments
Polypus & Dressing Forceps
Cotton Swab Forceps



Cheron
WI-09I-017
25.0 cm / 10"



Bozemann
WI-09I-018
26.0 cm / 10 1/4"

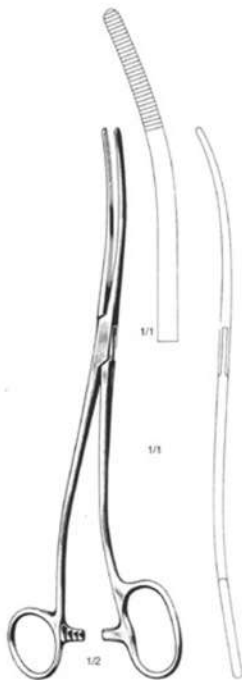

Bozemann-Douglass
WI-09I-019
26.0 cm / 10 1/4"

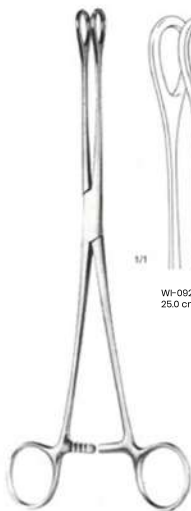

Foerster
 WI-092-020 - WI-092-027



WI-092-020
 25.0 cm / 10"



WI-092-021 - 18.0 cm / 7"
 WI-092-022 - 20.0 cm / 8"
 WI-092-023 - 25.0 cm / 10"



WI-092-024
 25.0 cm / 10"



WI-092-025 - 18.0 cm / 7"
 WI-092-026 - 20.0 cm / 8"
 WI-092-027 - 25.0 cm / 10"

General Instruments Polypum, Tumor, Swab Forceps



Foester
Wi-093-028 - Wi-093-029
25.0 cm / 10"



1/1



WI-093-028



WI-093-029



Ramley
Wi-093-030
25.0 cm / 10"

General Instruments Micro-Needle Holders



1/1



WI-094-001

WI-094-002



1/1



WI-094-003

WI-094-004

1/2

WI-094-001-WI-094-002
18.0 cm / 7"

1/2

WI-094-003-WI-094-004
18.0 cm / 7"



1/1



Barraquer
WI-094-005
18.0 cm / 6 3/4"

1/1



1/2

Barraquer
WI-094-006
14.0 cm / 5 1/2"

1/1



1/2

Kalt
WI-094-0077
14.0 cm / 5 1/2"

General Instruments Micro-Needle Holders

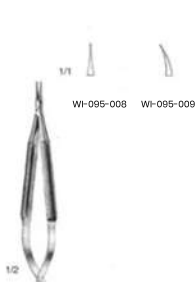

WI-095-008 WI-095-009

Barraquer-Troutman
WI-095-008-WI-095-009
10.0 cm / 4"

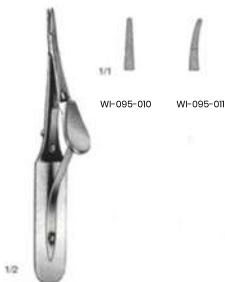

WI-095-010 WI-095-011

Arruga
WI-095-010-WI-095-011
14.0 cm / 5 1/2"

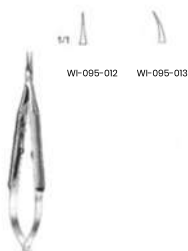

WI-095-012 WI-095-013

Barraquer-Troutman
WI-095-013-WI-095-013
10.0 cm / 4"

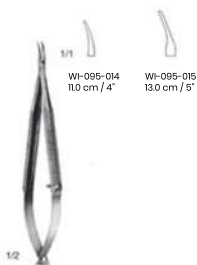

WI-095-014 WI-095-015
11.0 cm / 4" 13.0 cm / 5"

Barraquer
WI-095-014-WI-095-015



Barraquer
WI-095-016
14.0 cm / 5 1/2"



WI-095-017
13.0 cm / 5"

General Instruments Micro-Needle Holders



1/1



WI-096-018



WI-096-019



1/2

Castroviejo
WI-096-018-WI-096-019
9.0 cm / 3 1/2"

1/1



WI-096-020



WI-096-021



1/2

Castroviejo
WI-096-020-WI-096-021
9.0 cm / 3 1/2"

1/1



WI-096-022



WI-096-023



1/2

Castroviejo
WI-096-022-WI-096-023
14.0 cm / 5 1/2"

1/1



WI-096-024



WI-096-025



1/2

Castroviejo
WI-096-024-WI-096-025
14.0 cm / 5 1/2"

General Instruments Micro-Needle Holders

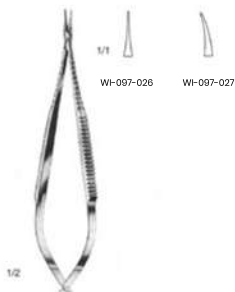

WI-097-026

WI-097-027

Castroviejo
WI-097-026-WI-097-027
14.0 cm / 5 $\frac{1}{2}$ "

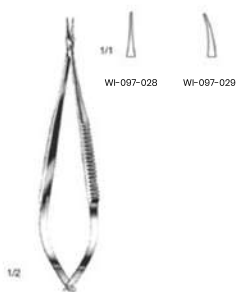

WI-097-028

WI-097-029

Castroviejo
WI-097-028-WI-097-029
14.0 cm / 5 $\frac{1}{2}$ "

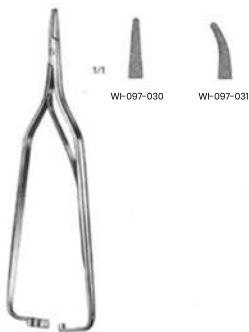

WI-097-030

WI-097-031

Castroviejo
WI-097-030-WI-097-031
16.0 cm / 6 $\frac{1}{4}$ "

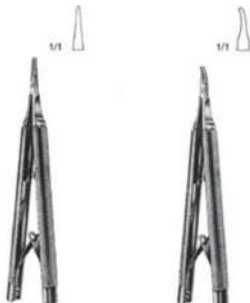

Castroviejo
WI-097-032
13.0 cm / 5 $\frac{1}{4}$ "

Castroviejo-Barraquer
WI-097-033
12.0 cm / 4 $\frac{3}{4}$ "

General Instruments Micro-Needle Holders

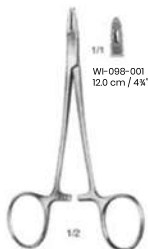

WI-098-001
12.0 cm / 4 3/4"



WI-098-002
12.5 cm / 5"



Collier
WI-098-003
12.5 cm / 2"

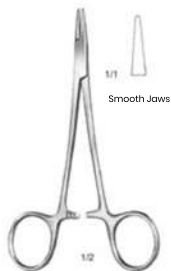

Webster
WI-098-004
13.0 cm / 5"

Smooth Jaws, with special groove

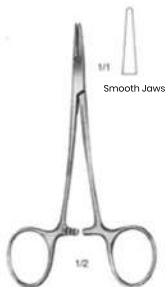

Haisey
WI-098-005
13.0 cm / 5"



Neivert
WI-098-006
13.0 cm / 5"



Hegar-Baumgartner
WI-098-007
14.0 cm / 5 1/2"



Brown
WI-098-008 - 13.0 cm / 5"
WI-098-009 - 18.0 cm / 7"

General Instruments Needle Holders



Crile-Murray
WI-099-010
15.0 cm / 6"



Crile-Wood
WI-099-011
15.0 cm / 6"



Adson
WI-099-012
18.0 cm / 7"



Metzenbaum
WI-099-013
18.0 cm / 7"



M.G.H. (Mass-General-Hospital)
WI-099-014
17.0 cm / 6 3/4"



Mayo-Hegar
WI-099-015-WI-099-021



WI-099-015
14.0 cm / 5 1/2"



WI-099-016
16.0 cm / 6 3/4"



WI-099-017
18.0 cm / 7"



WI-099-018
20.0 cm / 8"



WI-099-019
24.0 cm / 9 1/2"



WI-099-020
26.0 cm / 10 3/4"



WI-099-021
30.0 cm / 12"

General Instruments Needle Holders

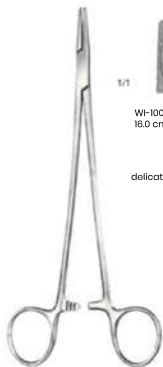

Mayo-Hegar
WI-100-022-WI-100-024

1/1



WI-100-022
16.0 cm / 6 1/4"



WI-100-023
18.0 cm / 7"



WI-100-024
20.0 cm / 8"

delicate pattern



Jamison
WI-100-025
23.5 cm / 9 1/4"

1/1



1/4

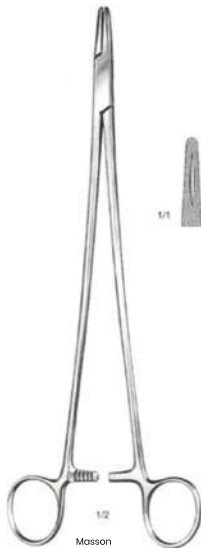

Masson
WI-100-026
27.0 cm / 10 5/8"

1/1



1/2

Suture Needles Holders



Finocchioletto
WI-101-027
27.0 cm / 10½"



Wangenstoën
WI-101-028
27.0 cm / 10½"



Johnson
WI-101-029
27.0 cm / 10½"

Suture Needles Holders

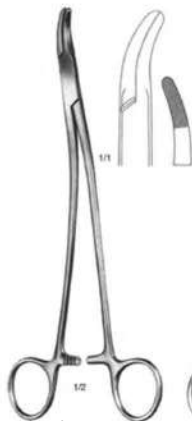

Stratte
WI-102-030
23.0 cm / 9"

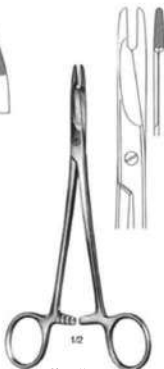

Olsen-Hegar
WI-102-031
17.0 cm / 6 1/4"

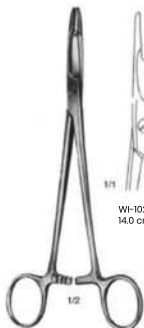

WI-102-032
14.0 cm / 4 1/2"

WI-102-033
18.0 cm / 7"

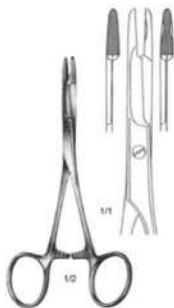

Olsen-Hegar
WI-102-034
14.0 cm / 5 1/2"



Gillies
WI-102-035
16.0 cm / 6 1/4"



Crile
WI-102-036
15.0 cm / 6"

Suture Needles Holders



Mathieu
WI-103-037-WI-103-039



WI-103-037
14.0 cm / 5½"

WI-103-038
17.0 cm / 6¾"

WI-103-039
20.0 cm / 8"



Mathieu
WI-103-030-WI-103-041



WI-103-040
14.0 cm / 5½"

WI-103-041
17.0 cm / 6¾"

Slender jaws



Mathieu
WI-103-042-WI-103-043



WI-103-042
17.0 cm / 6¾"

WI-103-043
20.0 cm / 8"



Toennis
WI-103-044
18.0 cm / 7"



Lichtenberg
WI-103-045
20.0 cm / 8"



Suture Reverdin Needles



1/2



Fig. 1
WI-104-001



Fig. 2
WI-104-002



Fig. 3
WI-104-003



Fig. 4
WI-104-004

Reverdin
WI-104-001-WI-104-004
14.0 cm / 5 1/2"



1/2



Fig. 1
WI-104-005
WI-104-009



Fig. 2
WI-104-006
WI-104-010



Fig. 3
WI-104-007
WI-104-011



Fig. 4
WI-104-008
WI-104-012

Reverdin
WI-104-005-WI-104-008
22.5 cm / 8 7/8"



1/2

Reverdin
WI-104-009-WI-104-012
19.5 cm / 7 3/4"

Suture Ligature Needles



Need

1/2



1/1



1

1/2



1/1



1/2



General Instruments

Scissors With Tungsten Carbide Inserts



GOLD PLATED



Standard
WI-106-001-WI-106-003



WI-106-001
14.5 cm / 5 $\frac{1}{2}$ "



WI-106-002
16.5 cm / 6 $\frac{1}{2}$ "



WI-106-003
18.5 cm / 7 $\frac{1}{4}$ "



Standard
WI-106-004-WI-106-006



WI-106-004
14.5 cm / 5 $\frac{1}{2}$ "



WI-106-005
16.5 cm / 6 $\frac{1}{2}$ "



WI-106-006
18.5 cm / 7 $\frac{1}{4}$ "

General Instruments

Scissors With Tungsten Carbide Inserts



GOLD PLATED



Standard
WI-106-007-WI-106-009

1/1



WI-106-007
14.5 cm / 5 3/4"



WI-106-008
16.5 cm / 6 1/2"

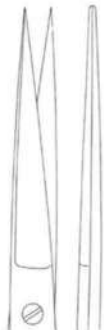

WI-106-009
18.5 cm / 7 1/4"



Standard
WI-106-004-WI-106-006

1/1



WI-106-004
14.5 cm / 5 3/4"

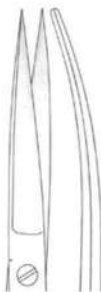

WI-106-005
16.5 cm / 6 1/2"



WI-106-006
18.5 cm / 7 1/4"

General Instruments

Scissors With Tungsten Carbide Inserts

GOLD PLATED



Mayo
WI-108-001-WI-108-003



WI-108-001
14.5 cm / 5 3/4"

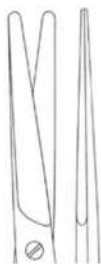

WI-108-002
17.0 cm / 6 3/4"

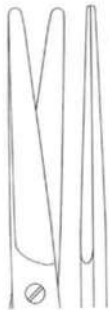

WI-108-003
23.0 cm / 9"



Mayo
WI-108-004-WI-108-006



WI-108-004
14.5 cm / 5 3/4"



WI-108-005
17.0 cm / 6 3/4"

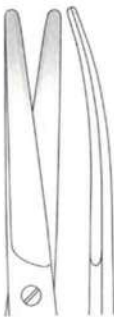

WI-108-006
23.0 cm / 9"

General Instruments Scissors With Tungsten Carbide Inserts



GOLD PLATED



WI-109-007-WI-109-009



1/1

WI-109-007
14.0 cm / 5 1/2"



WI-109-008
17.0 cm / 7"



WI-109-009
23.0 cm / 9"

General Instruments

Scissors With Tungsten Carbide Inserts



GOLD PLATED



Mayo-Style
WI-110-010-WI-110-011



WI-110-010
15.0 cm / 6"

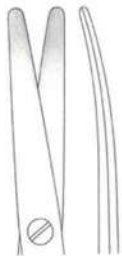

WI-110-011
17.0 cm / 7"



Mayo-Style
WI-110-012-WI-110-013

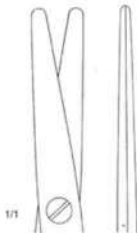

WI-110-012
15.0 cm / 6"

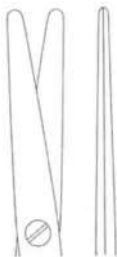

WI-110-013
17.0 cm / 7"

General Instruments Scissors With Tungsten Carbide Inserts



GOLD PLATED



Metzenbaum
WI-III-001-WI-III-002



WI-III-001
11.5 cm / 4 1/2"

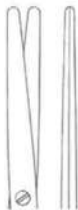

WI-III-002
14.5 cm / 5 3/4"



Metzenbaum
WI-III-003-WI-III-004



WI-III-003
11.5 cm / 4 1/2"



WI-III-004
14.5 cm / 5 3/4"

General Instruments Scissors With Tungsten Carbide Inserts

GOLD PLATED



WI-112-005
18.0 cm / 7"

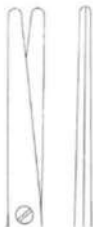

WI-112-006
20.0 cm / 8"



WI-112-007
23.0 cm / 9"



Metzenbaum
WI-112-005-WI-112-010



WI-112-008
25.0 cm / 10"



WI-112-009
28.0 cm / 11"

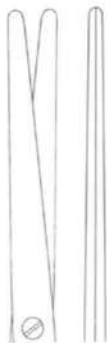

WI-112-012
30.0 cm / 12"

General Instruments

Scissors With Tungsten Carbide Inserts



GOLD PLATED



WI-113-011
18.0 cm / 7"



WI-113-012
20.0 cm / 8"



WI-113-013
23.0 cm / 9"



Metzenbaum
WI-113-011-WI-113-016



WI-113-014
25.0 cm / 10"



WI-113-015
28.0 cm / 11"



WI-113-016
30.0 cm / 12"

General Instruments

Scissors With Tungsten Carbide Inserts

GOLD PLATED



1/2
Metzenbaum-Lahey
WI-114-017
14.0 cm / 5 1/2"



1/2
Toennis-Adson
WI-114-018
17.0 cm / 7"

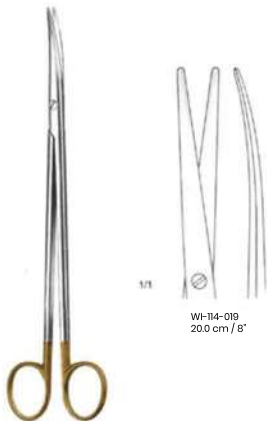

1/1
Metzenbaum
WI-114-019-WI-114-020

1/1
WI-114-019
20.0 cm / 8"

1/1
WI-114-020
23.0 cm / 9"

General Instruments Scissors With Tungsten Carbide Inserts

GOLD PLATED

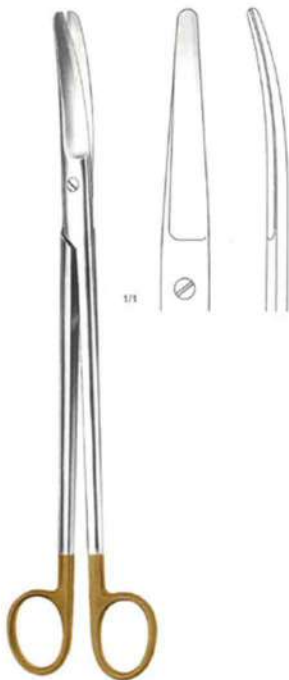

1/1

1/2

Mayo-Harrington
WI-115-021
28.0 cm / 11"

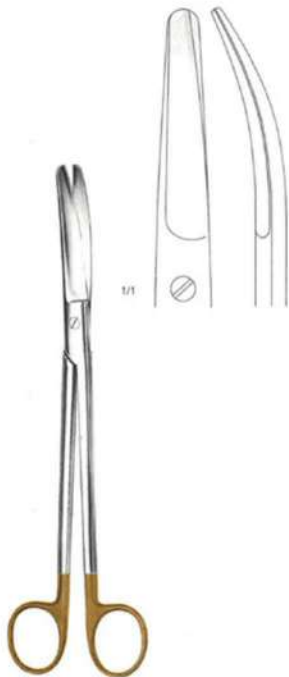

1/1

1/2

Sims
WI-115-022
23.0 cm / 9"

General Instruments Scissors With Tungsten Carbide Inserts



GOLD PLATED



WI-116-001
13.0 cm / 5"

WI-116-002
13.0 cm / 5"

WI-116-003
11.5 cm / 4 1/2"

WI-116-004
11.5 cm / 4 1/2"



De Bakey
(Potts-Smith)
WI-116-005-WI-116-010



WI-116-005
19.0 cm / 7 1/2"
25°

WI-116-006
19.0 cm / 7 1/2"
45°

WI-116-007
19.0 cm / 7 1/2"
60°



WI-116-008
19.5 cm / 7 3/4"
25°

WI-116-009
19.5 cm / 7 3/4"
45°

WI-116-010
23.0 cm / 9"
60°

General Instruments Supercut Scissors - General Surgery



Mayo Scissors

WI-117-001 - 14.0 cm / 5½" straight
WI-117-002 - 14.0 cm / 5½" curved
WI-117-003 - 17.0 cm / 6¾" straight
WI-117-004 - 17.0 cm / 6¾" curved

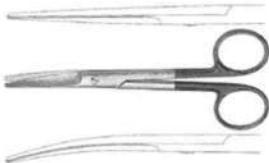

Mayo Scissors

WI-117-005 - 23.0 cm / 9" straight
WI-117-006 - 23.0 cm / 9" curved

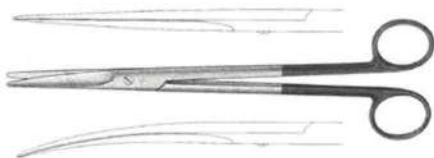

Metzenbaum (Lahey)

WI-117-007 - 14.6 cm / 5¾" straight
WI-117-008 - 14.6 cm / 5¾" curved

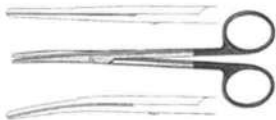

Metzenbaum

WI-117-009 - 18.0 cm / 7" curved
WI-117-010 - 23.0 cm / 9" curved



Iris Scissors

WI-117-011 - 11.5 cm / 4½" straight
WI-117-012 - 11.5 cm / 9½" curved



General Instruments Supercut Scissors Plastic and Reconstructive



Knight Nasal Scissors
WI-118-013 - 17.0 cm / 6 $\frac{3}{4}$ "

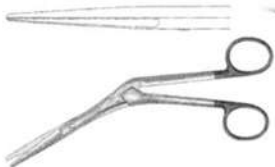

Plastic Surgery Scissors
WI-118-014 - 12.0 cm / 4 $\frac{1}{2}$ " straight
WI-118-015 - 12.0 cm / 4 $\frac{1}{2}$ " curved

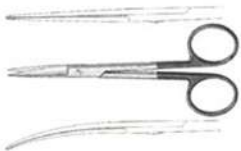

Castanares Face Lift Scissors
WI-118-016 - 16.0 cm / 6 $\frac{1}{4}$ " straight



Gorney
WI-118-017 - 18.5 cm / 7 $\frac{1}{2}$ " straight
WI-118-018 - 18.5 cm / 7 $\frac{1}{2}$ " curved

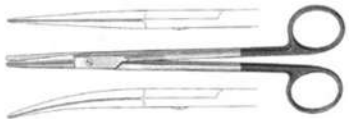

General Instruments Supercut Scissors Plastic and Reconstructive



Kaye Face Lift Scissors
beveled blades have semi-sharp outer edges

WI-119-019 - 15.0 cm / 6" curved
WI-119-020 - 19.0 cm / 7½" curved

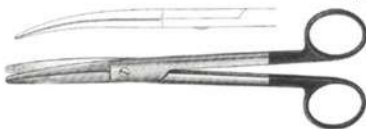

Freeman-Gorney Face Lift Scissors
beveled blades have semi-sharp outer edges
and flat, tapered tips:

WI-119-021 - 15.0 cm / 6" curved
WI-119-022 - 19.0 cm / 7½" curved

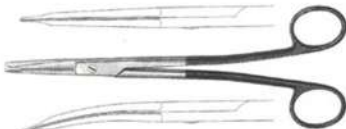

Freeman-Kaye Face Lift Scissors
beveled blades have semi-sharp outer edges
and flat, tapered tips:

WI-119-023 - 18.0 cm / 7" curved
WI-119-024 - 18.0 cm / 7" curved

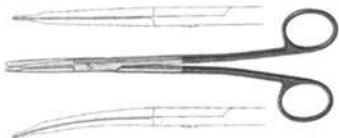

Freeman Rhytidectomy Scissors
WI-119-025 - 18.0 cm / 7" curved with flat tips



Gorney Platysma Scissors
beveled blades have semi-sharp
outer edges and flat, tapered tips:

WI-119-026 - 23.0 cm / 9" straight
WI-119-027 - 23.0 cm / 9" curved

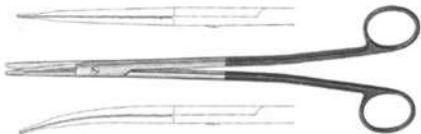

General Instruments Supercut Scissors Plastic and Reconstructive



Formon Lateral Scissors,
WI-120-028 - 13.0 cm / 5" full curved

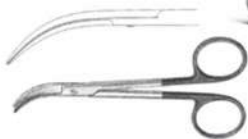

Formon Lateral Scissors,
WI-120-029 - 14.6 cm / 5 7/8" angled on flat



Cottle Dorsal Scissors,
WI-120-030 - 16.5 cm / 6 1/2" angled on flat



Plastic and Reconstructive Scissors
WI-120-031 - 11.4 cm / 4 1/2" curved
WI-120-032 - 14.6 cm / 5 7/8" curved



Petit-point Reynolds Scissors
WI-120-033 - 13.0 cm / 5" curved

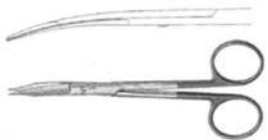

General Instruments Supercut Scissors Cardiovascular



Jamison Scissors
WI-121-034 - 14.0 cm / 5½" curved
WI-121-035 - 18.0 cm / 7" curved



Metzenbaum Scissors
WI-121-036 - 18.0 cm / 7" curved, delicate



Endarterectomy Scissors
WI-121-037 - 17.0 cm / 6¾" curved



General Instruments

Supercut Scissors

Cardiovascular



Potte-Smith Scissors

WI-122-038 - 18.0 cm / 7" 25°

WI-122-039 - 18.0 cm / 7" 45°

WI-122-040 - 18.0 cm / 7" 60°



Diethrich Coronary Artery Scissors

WI-122-041 - 18.0 cm / 7" 25°

WI-122-042 - 18.0 cm / 7" 45°

WI-122-043 - 18.0 cm / 7" 60°

WI-122-044 - 18.0 cm / 7" 90°

WI-122-045 - 18.0 cm / 7" 125°



Diethrich Coronary Artery Scissors

WI-122-041 - 18.0 cm / 7" 130°

shanks are stabilized
to keep blades in alignment

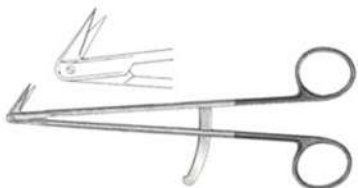

General Instruments Supercut Scissors Cardiovascular



GOLD PLATED



Ferris-Smith
WI-123-001
17.0 cm / 6 3/4"
Normal Profile



Bonney
WI-123-002-WI-123-003
Normal Profile



WI-123-002
17.0 cm / 6 3/4"
WI-123-003
17.0 cm / 6 3/4"



Gerald
WI-123-004-WI-123-005



WI-123-004
17.0 cm / 6 3/4"
WI-123-005
17.0 cm / 6 3/4"

Micro Profile

Micro Profile



Gillies
WI-123-006
15.0 cm / 6"
Mini profile



Mc Indoe
WI-123-007
15.0 cm / 6"
Mini profile



Semken
WI-123-008-WI-123-011



WI-123-008
16.0 cm / 6 3/4"
Normal profile

WI-123-009
18.0 cm / 7"

WI-123-010
16.0 cm / 6 3/4"
Mini profile

WI-123-011
18.0 cm / 7"

General Instruments Dessecting Forceps Tungsten Carbide Inserts



GOLD PLATED



Adson-Brown
WI-124-012
12.0 cm / 4 3/8"

Normal profile



WI-124-013
12.0 cm / 4 3/8"

WI-124-014
15.0 cm / 6"

Micro-Adson
WI-124-013- WI-124-014

Mini profile



WI-124-015
12.0 cm / 4 3/8"

WI-124-016
12.0 cm / 4 3/8"

WI-124-017
15.0 cm / 6"

WI-124-018
15.0 cm / 6"

Adson
WI-124-015- WI-124-018

Normal profile



with dissector end

Cushing
WI-124-019
17.5 cm / 7"

Normal profile



with dissector end

Cushing
WI-124-020
18.0 cm / 7"

Normal profile



Cushing-Taylor
WI-124-021
18.0 cm / 7"

Normal profile

General Instruments Dessecting Forceps, Tungsten Carbide Inserts



GOLD PLATED



1/1

WI-125-022
15.0 cm / 6"

WI-125-023
18.0 cm / 7"

WI-125-024
20.0 cm / 8"

WI-125-025
23.0 cm / 9"

WI-125-026
25.0 cm / 10"

Normal profile

Potts-Smith
WI-125-022-WI-125-026



1/1

WI-125-027
14.0 cm / 5½"

WI-125-028
16.0 cm / 6"

WI-125-029
18.0 cm / 7"

WI-125-030
20.0 cm / 8"

WI-125-031
25.0 cm / 10"

WI-125-032
30.0 cm / 12"

Normal profile

Oehler
WI-125-027-WI-125-032

General Instruments Dessecting Forceps, Tungsten Carbide Inserts



GOLD PLATED

Micro profile

Mini profile



WI-126-033
15.0 cm / 6"



WI-126-034
19.0 cm / 7½"



WI-126-035
24.0 cm / 9½"



WI-126-036
15.0 cm / 6"



WI-126-037
19.0 cm / 7½"



WI-126-038
24.0 cm / 9½"

De Bakay
WI-126-033-WI-126-038



WI-126-040
15.0 cm / 6"



WI-126-041
23.0 cm / 9"



WI-126-042
25.0 cm / 10"



Wangensteen
WI-126-040-WI-126-042

Normal profile



WI-126-039
15.0 cm / 6"

Smooth

Sature Needle Holders Tungsten Carbide Inserts



GOLD PLATED



1/1



WI-127-001

with lock



WI-127-002

with lock



WI-127-003

without lock



WI-127-004

without lock

Micro profile

Vascular
WI-127-001-WI-127-004
18.0 cm / 7"

1/1



WI-127-005
18.0 cm / 6 3/4"



WI-127-006
18.0 cm / 7"



WI-127-007
20.0 cm / 8"



WI-127-008
23.0 cm / 9"



WI-127-009
26.0 cm / 10 1/4"

Micro profile



Dietrich
WI-127-005-WI-127-009

Sature Needle Holders Tungsten Carbide Inserts



GOLD PLATED



Castroviejo
WI-128-010-WI-128-015

1/1



WI-128-010
14.0 cm / 5½"

smooth



WI-128-011
18.0 cm / 7"

Micro profile



WI-128-012
21.0 cm / 8¼"

Micro profile



WI-128-013
14.0 cm / 5½"

smooth



WI-128-014
18.0 cm / 7"

Micro profile



WI-128-015
21.0 cm / 8¼"

Micro profile

1/1



WI-128-016



WI-128-017

Micro profile

1/1



smooth



Castroviejo
WI-128-018
13.0 cm / 5"



smooth



Baraquer
WI-128-019
13.0 cm / 5"



smooth



Baraquer
WI-128-020
13.0 cm / 5"

Arruga
WI-128-016-WI-128-017
16.0 cm / 6¼"

Sature Needle Holders Tungsten Carbide Inserts



GOLD PLATED

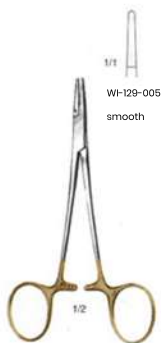
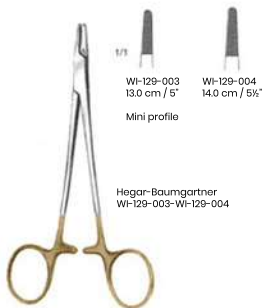
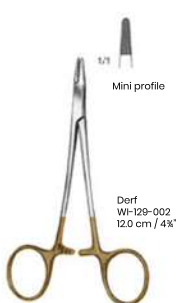

Halsey
WI-129-005-WI-129-006
13.0 cm / 5"



Webster
WI-129-007
12.0 cm / 4 3/4"



Crile-Wood
WI-129-008
15.0 cm / 6"

Sature Needle Holders Tungsten Carbide Inserts



GOLD PLATED

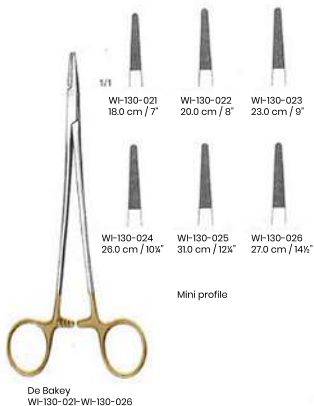
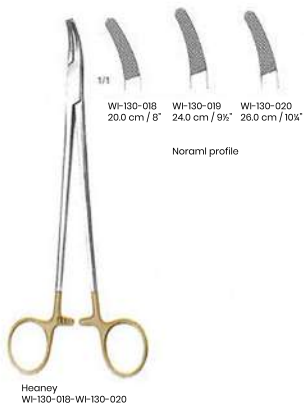
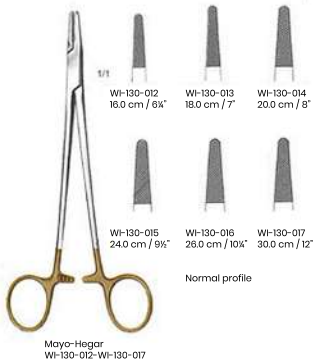
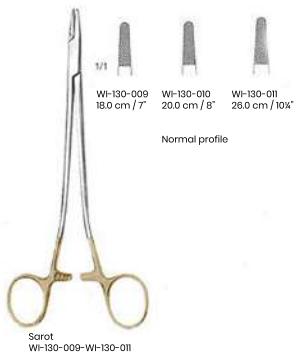

Sature Needle Holders Tungsten Carbide Inserts



GOLD PLATED



Normal profile

Masson
WI-131-027
27.0 cm / 10½"

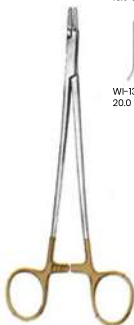

Ryder
WI-131-028-WI-131-033

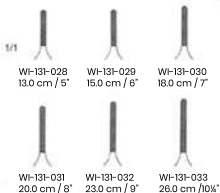

Mini profile



Special Model
WI-131-034-WI-131-036

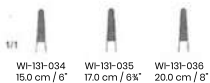

Mini profile

Sature Needle Holders Tungsten Carbide Inserts

GOLD PLATED

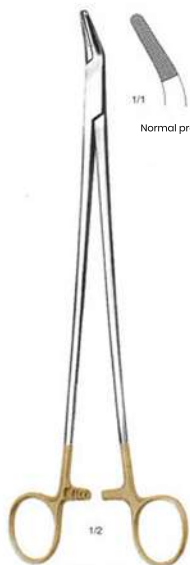

Normal profile

1/2

Finocchietto
WI-132-037
27.0 cm / 10 5/8"

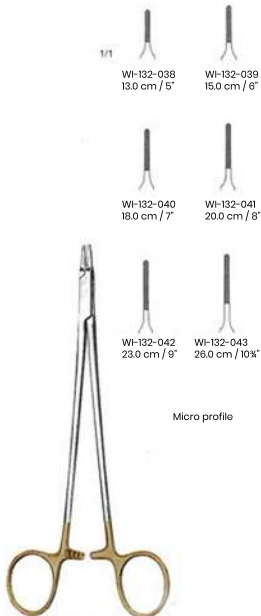

Micro profile



Normal profile

1/2

Wangensteen
WI-132-044
27.0 cm / 10 5/8"



Ryder-Vascular
WI-132-038-WI-132-043

Sature Needle Holders Tungsten Carbide Inserts



GOLD PLATED



WI-133-045
14.0 cm / 5½"

1/1

WI-133-046
18.0 cm / 7"

WI-133-047
20.0 cm / 8"

WI-133-048
3.0 cm / 9"

Micro profile

Hegar-Vascular
WI-133-045-WI-133-048

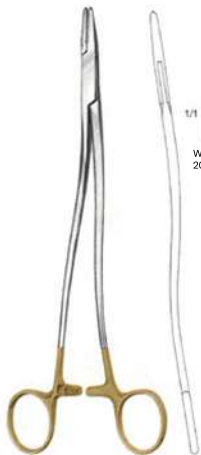

1/1

WI-133-049
20.0 cm / 8"

WI-133-050
24.0 cm / 9½"

WI-133-051
26.0 cm / 10½"

Normal profile

Bozemann
WI-133-049-WI-133-051



1/1

WI-133-052
20.0 cm / 8"

WI-133-053
24.0 cm / 9½"

Normal profile

Hegar
WI-133-052-WI-133-053

Suture Needle Holders Tungsten Carbide Inserts



GOLD PLATED



WI-134-054
22.0 cm / 8 1/2"

WI-134-055
23.0 cm / 9"

Normal profile

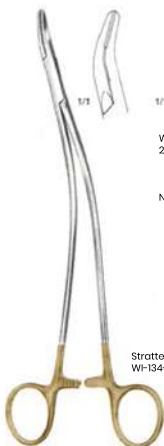

Stratte
WI-134-054-WI-134-055



WI-134-056
14.0 cm / 5 1/2"

WI-134-057
16.5 cm / 6 1/2"

WI-134-058
18.0 cm / 7"

Normal profile

Olsen-Hegar
WI-134-056-WI-134-058



1/2

Gillies
WI-134-059
16.0 cm / 6 1/4"

Normal profile

Sature Needle Holders Tungsten Carbide Inserts



GOLD PLATED



1/1

WI-135-060
14.0 cm / 5½"



WI-135-061
17.0 cm / 6"



WI-135-062
20.0 cm / 8"

Normal profile

Mathieu-Kocher
WI-135-060-WI-135-062



1/1

WI-135-063
14.0 cm / 5½"



WI-135-064
17.0 cm / 6"



WI-135-065
20.0 cm / 8"

Normal profile

Mathieu
WI-135-063-WI-135-065



1/1

WI-135-066
17.0 cm / 6½"



WI-135-067
20.0 cm / 8"



WI-135-068
23.0 cm / 9"

Normal profile

Mathieu
WI-135-066-WI-135-068

Sature Needle Holders Tungsten Carbide Inserts



GOLD PLATED



Normal profile

Toennis
WI-136-069
18.0 cm / 7"



Normal profile

Lichtenberg
WI-136-070
20.0 cm / 8"

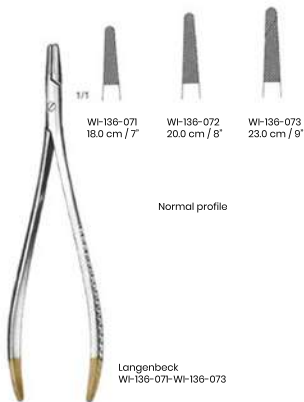

Normal profile

Langenbeck
WI-136-071-WI-136-073

WI-136-071
18.0 cm / 7"

WI-136-072
20.0 cm / 8"

WI-136-073
23.0 cm / 9"

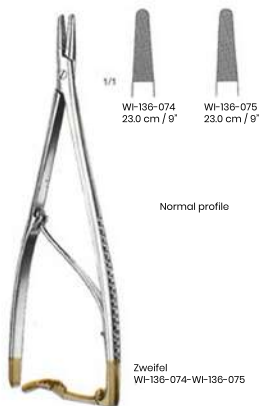

Normal profile

Zwiefel
WI-136-074-WI-136-075

WI-136-074
23.0 cm / 9"

WI-136-075
23.0 cm / 9"

Dressing Bandage Scissors



for fingers



Lister
 WI-137-001 - 9.0 cm / 3½"
 WI-137-002 - 14.0 cm / 5½"
 WI-137-003 - 18.0 cm / 7"
 WI-137-004 - 20.0 cm / 8"



Excentric
 WI-137-005 - 16.0 cm / 6¼"
 WI-137-006 - 19.0 cm / 7½"



1/2

Knowles
 WI-137-007
 14.0 cm / 5½"

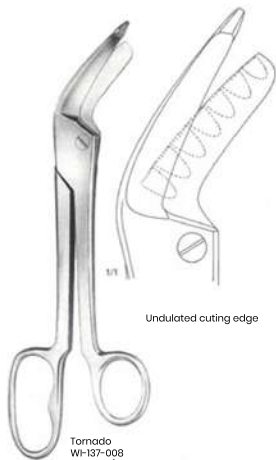

1/3

Undulated cutting edge

Tornado
 WI-137-008
 24.0 cm / 9½"



1/3

Bergmann
 WI-137-009
 23.0 cm / 9"

Dressing Clothing Scissors, Plastic Shears

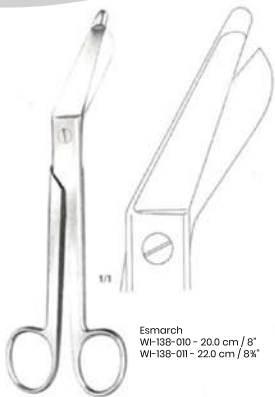

Esmarch
WI-138-010 - 20.0 cm / 8"
WI-138-011 - 22.0 cm / 8 3/4"



Lister
WI-138-012 - 15.0 cm / 6"
WI-138-013 - 17.0 cm / 7"

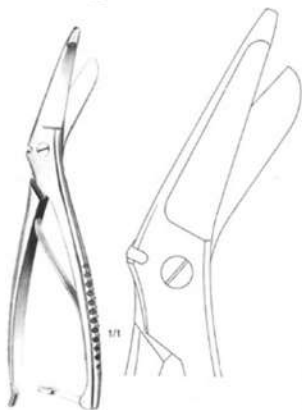

WI-138-014
20.0 cm / 8"



Bruns
WI-138-015
24.0 cm / 9 1/2"

Dressing Plaster Sheras, Bandage Scissors



Stile
WI-139-001-WI-139-003



WI-139-001
23.0 cm / 9"



WI-139-002
26.0 cm / 10¼"



WI-139-003
37.0 cm / 14½"

Tungstan Carbide

Tungstan Carbide



Lister
WI-139-004
18.0 cm / 7"



GOLD PLATED



Bruns
WI-139-002
21.0 cm / 8¼"



Dressing Plaster Sheras, Bandage Scissors



Engel
WI-140-006
14.0 cm / 5½"



Hopkins
WI-140-007
20.0 cm / 8"



Hopkins
WI-140-008
18.0 cm / 87"



Reiner
WI-140-009
18.0 cm / 7¼"



Special Mod. Weldon
WI-140-010
21.0 cm / 8¼"

Dressing Plaster Sheras, Bandage Scissors



Henning
WI-141-011
28.0 cm / 11"

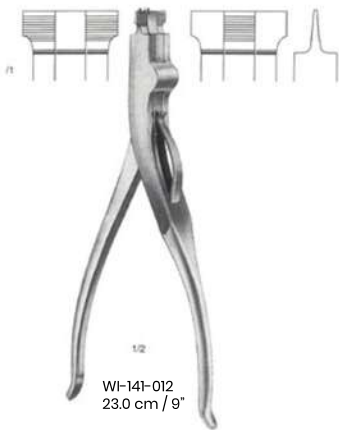

WI-141-012
23.0 cm / 9"

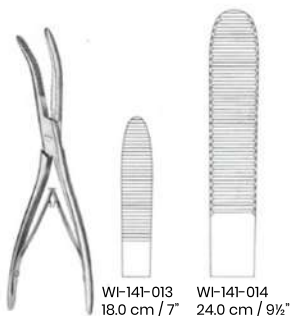

WI-141-013
18.0 cm / 7"

WI-141-014
24.0 cm / 9½"

Wolff
WI-141-013-WI-141-014

Dressing Plaster Sheras, Bandage Scissors

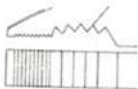

Slip Joint Adjustable Pliers
WI-143-003
19.7 cm / 7 $\frac{3}{4}$ "



Parallel Pliers
WI-143-004
18.0 cm / 7" . grooved 10mm wide jaws
for pin removal



Needle Nose Pliers
WI-143-005
14.0 cm / 5 $\frac{1}{2}$ " . grooved jaws
tips taper to 1mm

Dressing Plaster Sheras, Bandage Scissors



Cannulated Pin Cutter
WF-142-001
19.0 cm / 7½". end cutting
maximum capacity .062" (1.6mm)

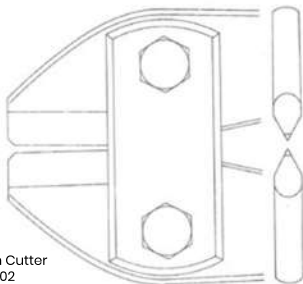
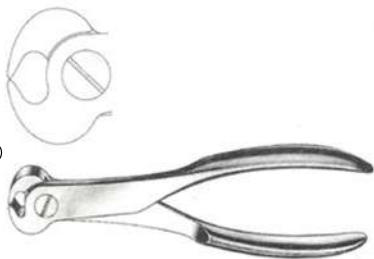

Large Pin Cutter
WF-142-002
55.6 cm / 22".
cut rods up to .250" (6.3mm).
toggle joint transfers leverage to the cutting blades

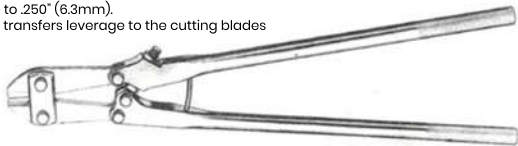

Dressing Plaster Sheras, Bandage Scissors



Flat Nose Pliers,
WI-144-006
15.0 cm / 6", tips taper to 2mm

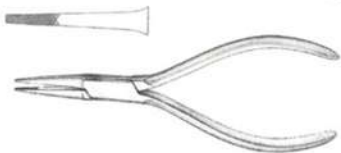

Flat Nose Pliers,
WI-144-007
16.5 cm / 6½",
tips taper to 3.5mm

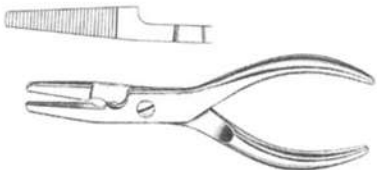

Heavy Duty Locking Pliers,
WI-144-008
17.0 cm / 6¾", 7mm wide tip
reinforced jaw hinge, self-locking
lever with adjustment screw
and one-handed quick release

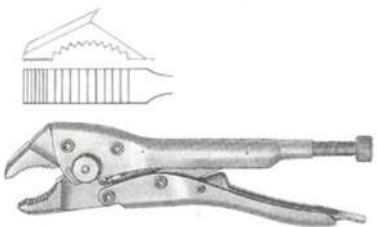

Dressing Plaster Sheras, Bandage Scissors



Heavy Duty Locking Pliers,
WI-145-009
20.0 cm / 8", 9mm wide tip
reinforced jaw hinge,
self-locking lever with adjustment
screw and one-handed quick release

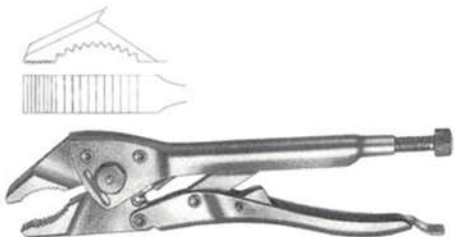

Heavy Duty Locking Pliers,
WI-145-010
24.0 cm / 9½", 5mm wide tip
reinforced jaw hinge,
self-locking lever with adjustment
screw and one-handed quick release

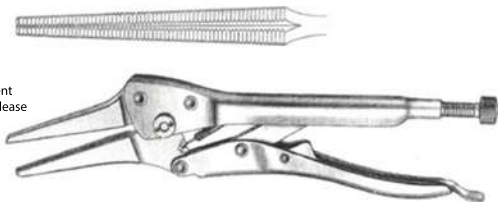

Townley Fermur Caliper,
WI-145-011
11.5 cm / 4½"



Dressing Plaster Sheras, Bandage Scissors



WI-146-001
2mm



WI-146-002
3mm



WI-146-002
4mm



WI-146-004
2mm



WI-146-005
3mm



WI-146-006
4mm

1/2

Buckley
WI-146-001-WI-140-006
16.0 cm / 6¼"



WI-146-007
8mm



WI-146-012
8mm



WI-146-017
8mm



WI-146-008
10mm



WI-146-013
10mm



WI-146-018
10mm



WI-146-009
12mm



WI-146-014
12mm



WI-146-019
12mm



WI-146-010
14mm



WI-146-015
14mm



WI-146-020
14mm



WI-146-011
16mm



WI-146-016
16mm



WI-146-021
16mm

WI-146-007-WI-140-011
13.5 cm / 5"

WI-14-012-WI-14-016
13.5 cm / 5¼"

WI-14-017-WI-14-021
13.5 cm / 5¼"

Dressing Plaster Sheras, Bandage Scissors



WI-147-001
11.0 cm / 1 1/2"



WI-147-002
11.0 cm / 1 1/2"



WI-147-003
10.0 cm / 4"



WI-147-004
10.0 cm / 4"

Buck-Gramcko
WI-147-001-WI-147-004



WI-147-005 WI-147-010
13.5 cm / 5 1/4" 17.0 cm / 6 3/4"



WI-147-015 WI-147-020
13.5 cm / 5 1/4" 17.0 cm / 6 3/4"



WI-147-006 WI-147-011
13.5 cm / 5 1/4" 17.0 cm / 6 3/4"



WI-147-016 WI-147-021
13.5 cm / 5 1/4" 17.0 cm / 6 3/4"



WI-147-007 WI-147-012
13.5 cm / 5 1/4" 17.0 cm / 6 3/4"



WI-147-017 WI-147-022
13.5 cm / 5 1/4" 17.0 cm / 6 3/4"



WI-147-008 WI-147-012
13.5 cm / 5 1/4" 17.0 cm / 6 3/4"



WI-147-018 WI-147-023
13.5 cm / 5 1/4" 17.0 cm / 6 3/4"



WI-147-009 WI-147-012
13.5 cm / 5 1/4" 17.0 cm / 6 3/4"



WI-147-019 WI-147-024
13.5 cm / 5 1/4" 17.0 cm / 6 3/4"



WI-147-025



WI-147-031



WI-147-026



WI-147-032



WI-147-027



WI-147-033



WI-147-028



WI-147-034



WI-147-028



WI-147-035



WI-147-030



WI-147-036

Partsch
WI-147-005-WI-147-024

Alexander
WI-147-025-WI-147-036
18.0 cm / 7"

Dressing Plaster Sheras, Bandage Scissors



10 mm
WI-148-001



10 mm
WI-148-005



10 mm
WI-148-009



15 mm
WI-148-003



15 mm
WI-148-006



15 mm
WI-148-010



20 mm
WI-148-004



20 mm
WI-148-007



20 mm
WI-148-011

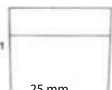

1/1
25 mm
WI-148-004



1/1
25 mm
WI-148-008



1/1
25 mm
WI-148-012



Stille
WI-148-001-WI-148-012
20.0 cm / 8"

Dressing Plaster Sheras, Bandage Scissors

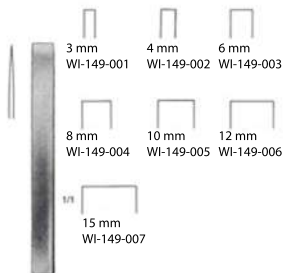

Mini-Lambotte
WI-149-001-WI-149-007
12.5 cm / 5"

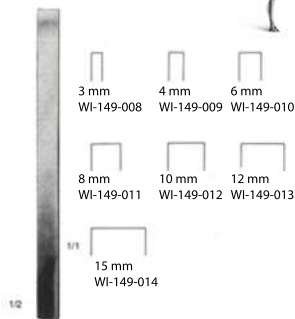

Mini-Lambotte
WI-149-008-WI-149-014
17.0 cm / 6¾"

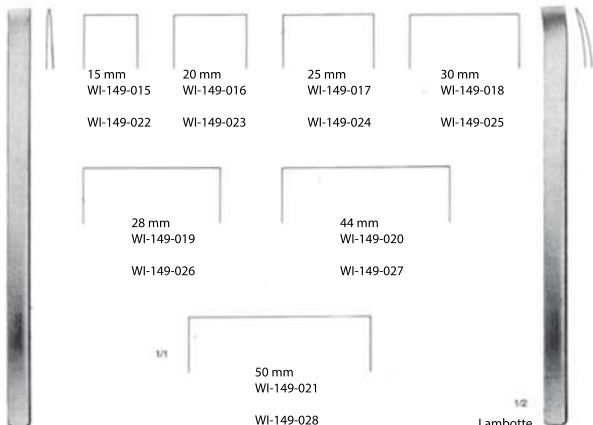

Lambotte
WI-149-015-WI-149-021
24.0 cm / 9½"

Lambotte
WI-149-022-WI-149-028
23.0 cm / 9"

Dressing Plaster Sheras, Bandage Scissors



6mm
WI-150-001



5mm
WI-150-001



9mm
WI-150-002

3mm
WI-150-001



9mm
WI-150-002



13mm
WI-150-003



13mm
WI-150-003



16mm
WI-150-004



16mm
WI-150-004



19mm
WI-150-005.



19mm
WI-150-005.



25mm
WI-150-006



25mm
WI-150-006



32mm
WI-150-007



32mm
WI-150-007



9mm
WI-150-015



9mm
WI-150-019



14mm
WI-150-016



14mm
WI-150-020



19mm
WI-150-017



19mm
WI-150-021



25mm
WI-150-018



25mm
WI-150-022

Smith-Petersen
WI-150-001-WI-150-022
20.0 cm / 8"

Bone Surgery Bone Chisel and Gouges



Hoke
WI-151-001-WI-151-005
17.0 cm / 6 3/4"



Hibbs
WI-151-006-WI-151-010
24.0cm / 9 1/2"



Hibbs
WI-151-011-WI-151-015
24.0cm / 9 1/2"

Bone Surgery Bone Chisel and Gouges

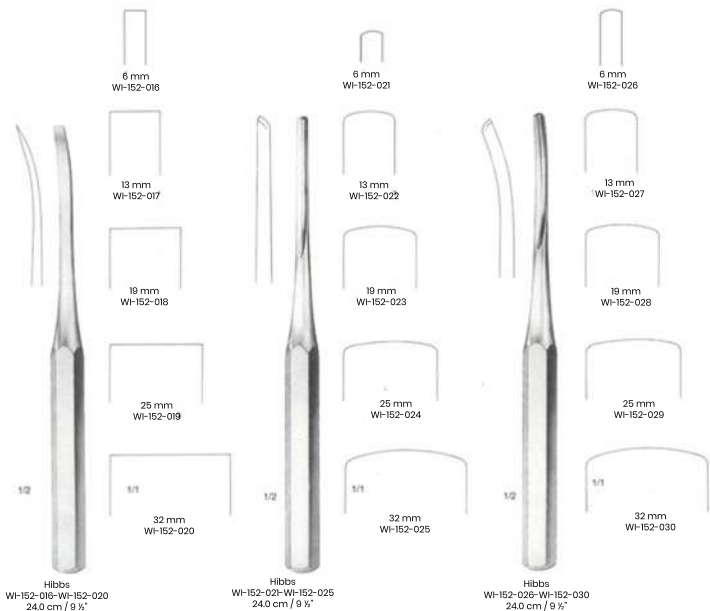

Bone Surgery Hemostats



1/2

Putti
WI-153-001
30.0 cm / 12"

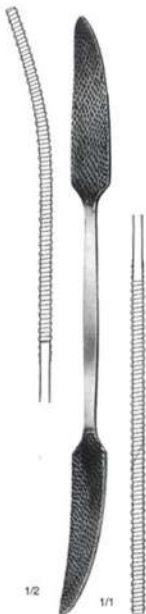

1/2

1/1

Putti
WI-153-002
27.0 cm / 10 1/2"

1/1
2 mm Ø
WI-153-003

3 mm Ø
WI-153-004

4 mm Ø
WI-153-005

5 mm Ø
WI-153-006

6 mm Ø
WI-153-007

8 mm Ø
WI-153-008

1/1
10 mm Ø
WI-153-009



1/2

WI-153-003-WI-153-009
15.5 cm / 6"

Bone Surgery Mallets

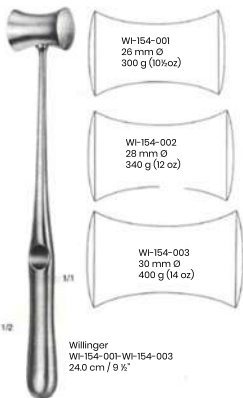

Willinger
WI-154-001-WI-154-003
24.0 cm / 9 ½"

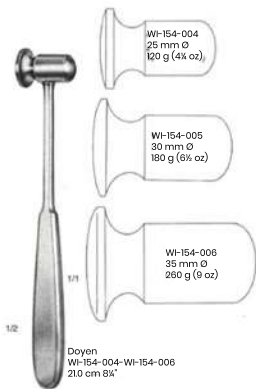

Doyen
WI-154-004-WI-154-006
21.0 cm 8 ¼"



Collin
WI-154-007
20.0 cm / 8"

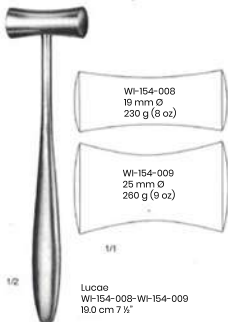

Lucas
WI-154-008-WI-154-009
19.0 cm 7 ½"



WI-154-010
16.5 cm / 6 ½"

Bone Surgery Mallets



30 mm Ø
510 g (18 oz)



1/2

WI-155-011
26.5 cm / 10½"

With interchangeable
Ferrozell faces

26 mm Ø
320 g (11 ¼ oz)



1/2

Mead
WI-155-012
17.0 cm / 6 ¾"
Solid

Ferrozell faces only, pair

22 mm Ø
200 g (7 oz)



1/2

Partsch
WI-155-013
18.0 cm / 7"

45 mm Ø
290 g (10 oz)



1/2

WI-155-014
23.0 cm / 9"
hardwood, lead fitted

Bone Surgery Mallets



80 x 60 mm Ø
400 g



Steinbach
WI-156-015
24.0 cm / 9 1/2"

Ferrozell. solid

42 mm Ø
250 g
400 g



WI-156-016
26.0 cm / 10 1/4"

plastic, lead filled

WI-156-017
26.0 cm / 10 1/4"

Ferrozell. Without Lead

42 mm Ø
250 g



WI-156-018
26.0 cm / 10 1/4"

Ferrozell. Lead filled



WI-156-019
26.5 cm / 10 1/2"

repercussion free

Bone Surgery Mallets



WI-157-023
Spare Faces, pair

42 mm Ø
530 g (19 oz)

30 mm Ø



1/2

WI-157-020
26.5 cm / 10 1/2"

steel, solid
with plastic handle

30 mm Ø
480 g



1/2

WI-157-021
24.0 cm / 9 1/2"

steel, solid
with plastic handle

37 mm Ø
370 g



1/2

WI-157-022
22.5 cm / 9"

steel, solid
with Ferrozell faces

30 mm
125 g (4 oz)



1/2

WI-157-024
22.5 cm / 9"

Ferrozell solid

Bone Surgery Mallets



450 g (1 lb)

900 g (2 lbs)



1/2

WI-158-025
24.0 cm / 9 1/2"

steel, solid
with plastic handle



1/2

WI-158-026
26.5cm / 10 1/2"

steel, solid



1/2

WI-158-027
26.5cm / 10 1/2"

steel, solid

Bone Surgery Bone Curettes

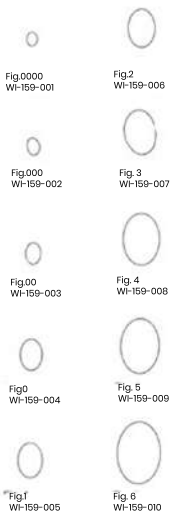

Volkman
WI-159-001-WI-159-010
17.0 cm / 6 3/4"

Handle from artificial wood

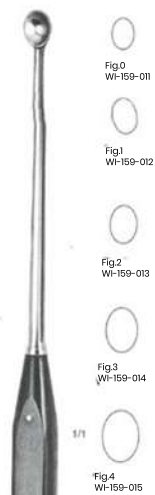

Volkman
WI-159-001-WI-159-015
27.0 cm / 10 3/4"

Handle from artificial wood

Bone Surgery Bone Curettes

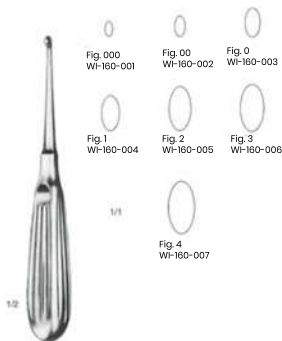

Schede
WI-160-001-WI-160-007

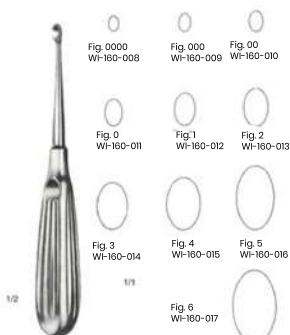

Volkmann
WI-160-008-WI-160-017

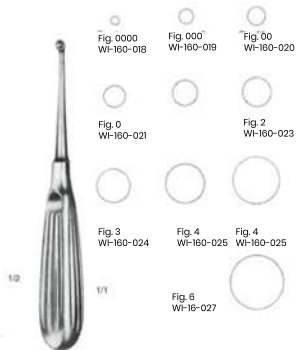

Bruns
WI-160-018-WI-160-027

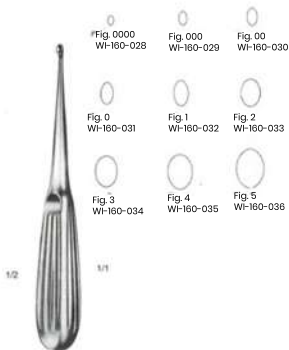

Spratt
WI-160-028-WI-160-036

Bone Surgery Bone Curettes



WI-161-009

WI-161-010

WI-161-011

WI-161-012

WI-161-013

WI-161-014

WI-161-015

WI-161-016

WI-161-017

WI-161-018

WI-161-019

WI-161-020

Fig. 00
WI-161-001

Fig. 00
WI-161-005

Fig. 0
WI-161-002

Fig. 0
WI-161-006

Fig. 1
WI-161-003

Fig. 1
WI-161-007

Fig. 2
WI-161-004

Fig. 2
WI-161-008

1/2

Willinger
WI-161-001-WI-161-008
17.5 cm / 7"

1/2

Bruns
WI-161-009-WI-161-017
23.5 cm / 9"

1/2

WI-161-018-WI-161-020
23.5 cm / 10"

Bone Surgery Bone Curettes

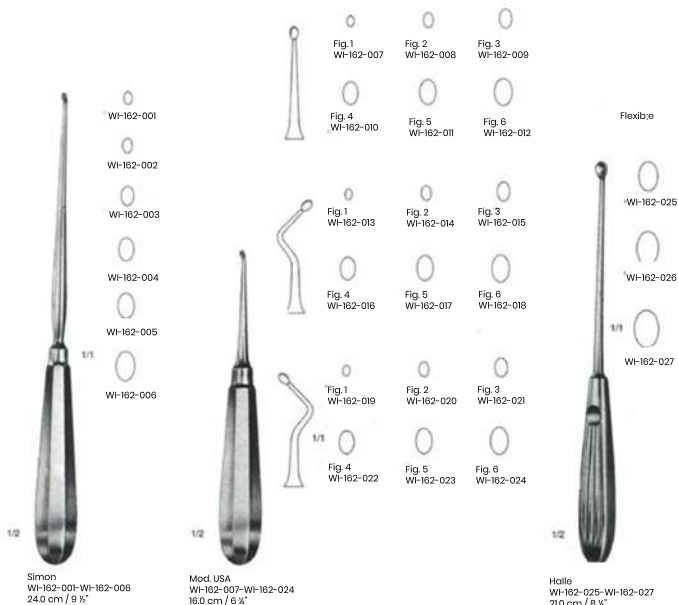

Bone Surgery Bone Curettes



WI-163-001
13.0 cm / 5"



WI-163-002
14.0 cm / 5 1/2"



WI-163-003
17.0 cm / 6 1/2"



WI-163-004
13.0 cm / 5"



WI-163-005
16.0 cm / 6 1/4"



WI-163-006
20.0 cm / 8"

Volkmann
WI-163-001-WI-163-003

Volkmann
WI-163-004-WI-163-006



WI-163-007
21.0 cm / 8 1/4"
oval/round



WI-163-008



WI-163-009



WI-163-010



Williger
WI-163-008-WI-163-010
13.5 cm / 5 1/4"



WI-163-011



WI-163-012



WI-163-013



Martini
WI-163-011-WI-163-013
13.5 cm / 5 1/4"

Bone Surgery Bone Curettes



Spinal Fusion Curettes 23.0 cm / 9", reverse angle

- WI-164-01 - Size 5-0
- WI-164-002 - Size 4-0
- WI-164-003 - Size 3-0
- WI-164-004- Size 2-0
- WI-164-005- Size 0
- WI-164-006 - Size 1
- WI-164-007- Size 2**
- WI-164-008 - Size 3
- WI-164-009- Size 4
- WI-164-010 - Size 5
- WI-164-011 - Size 6

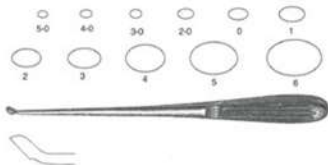

Bruns Oval Cup Curettes 23.0 cm / 9", straight solid hexagonal handle

- WI-164-012- Size 3-0
- WI-164-013 - Size 2-0
- WI-164-014 - Size 0
- WI-164-015- Size 1
- WI-164-016- Size 2
- WI-164-017 - Size3
- WI-164-018- Size 4**
- WI-164-019 - Size 5
- WI-164-020- Size 6

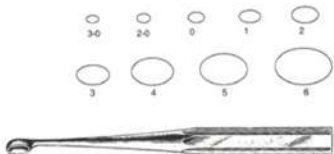

Semmes (howard) Spinal Curettes 23.0 cm / 9" 4 x 7 mm cup

- WI-164-021 - Straight
- WI-164-022 - Sight angle
- WI-164-023 - Acute Angle



Cobb-Type Oval Cup Curettes 27.9 cm / 11", hollow knurled handle

- | Staright | Angled Tip | |
|-------------------|-------------------|---------------|
| WI-164-024 | WI-164-033 | Size 3-0 |
| WI-164-025 | WI-164-034 | Size 2-0 |
| WI-164-026 | WI-164-035 | Size 0 |
| WI-164-027 | WI-164-036 | Size 1 |
| WI-164-028 | WI-164-037 | Size 2 |
| WI-164-029 | WI-164-038 | Size 3 |
| WI-164-030 | WI-164-039 | Size 4 |
| WI-164-031 | WI-164-040 | Size 5 |
| WI-164-032 | WI-164-041 | Size 6 |

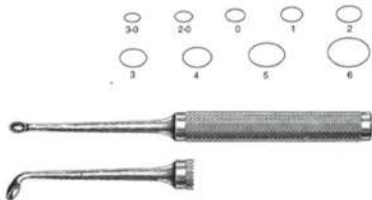

Bone Surgery

Bone Curettes and Hooks



Bone Hooks
23.0 cm / 9"

WI-165-001 - 9.5 mm / $\frac{3}{8}$ " hook
WI-165-002 - 19 mm / $\frac{3}{4}$ " hook
WI-165-003 - 25 mm / 1" hook

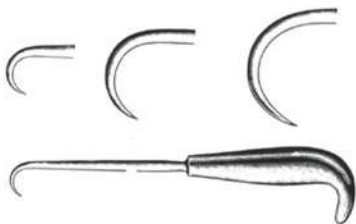

Volkman bone Curettes
double ended

WI-165-004 - 13.0 cm / 5" one round and one oval cup
10.5 mm and 6.3 mm x 6.8 mm
WI-165-005 - 16.5 cm 6 $\frac{1}{2}$ " two oval cups
7.5 mm x 14 mm and 9mm x 22mm
WI-165-006 - 6.5 cm 6 $\frac{1}{2}$ " one round and one oval cup
14 mm and 7mm x 9mm
WI-165-007 - 20.0 cm / 8" one round and one oval cup
17.5mm x and 9 mm x 11 mm



Scoville Disc Curettes
25.0 cm / 10" . 4 x 10mm cup

WI-165-008 - Straight
WI-165-009 - Reverse angled
WI-165-010 - Angled



Bone Surgery Bone Curettes



Cone Ring curettes 23.0 cm / 9"

- WI-166-011 - Straight, Size 1, 8mm diameter
- WI-166-012 - Straight, Size 2, 6mm diameter
- WI-166-013 - Straight, Size 3, 3mm diameter
- WI-166-014 - Angular, Size 1, 8mm diameter
- WI-166-015 - Angular, Size 2, 6mm diameter
- WI-166-016 - Angular, Size 3, 3mm diameter

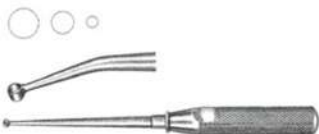

Cone Ring curettes 23.0 cm / 9", 8mm cup

- WI-166-017- 5° Angle
- WI-166-018- 30° Angle

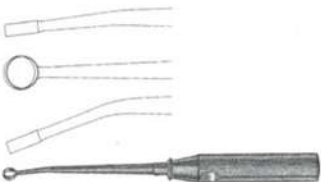

Epstein Spinal curettes 20.0 cm / 8", reverse angle

- WI-166-019- Size 3-0
- WI-166-020- Size 2-0
- WI-166-021- Size 0



Bone Surgery Periosteal Raspatories

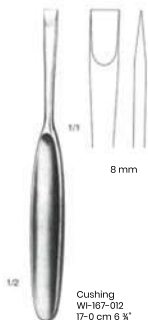
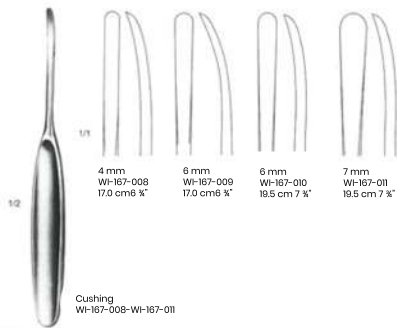
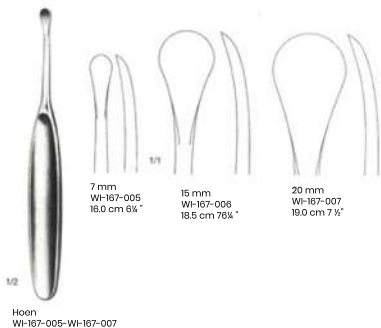
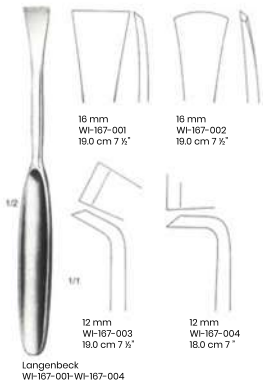

Bone Surgery Periosteal Raspatories

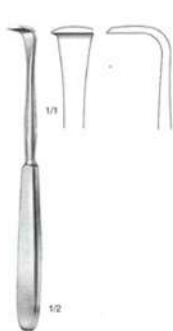

Langenbeck
WI-168-013
18.0 cm / 7"

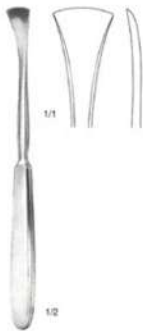

Langenbeck
WI-168-014
19.0 cm / 7½"

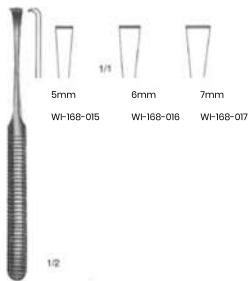

WI-168-015-WI-168-017
16.0 cm / 6¼"



Farabeuf
WI-168-018
15.0 cm / 6"



Farabeuf
WI-168-019
15.0 cm / 6"



Sedillot
WI-168-020
21.0 cm / 8¼"

Bone Surgery Periosteal Raspatories

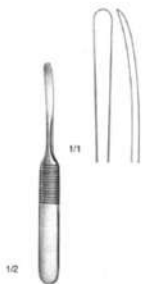

Williger
WI-169-021
13.0 cm / 5"



Williger
WI-169-022
16.0 cm / 6 1/4"



WI-169-023-WI-169-024
17.0 cm / 6 3/4"

6 mm
WI-169-023
8 mm
WI-169-024



Doyen
WI-169-025-WI-169-028
17.0 cm / 6 3/4"

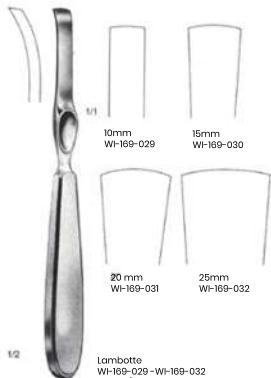
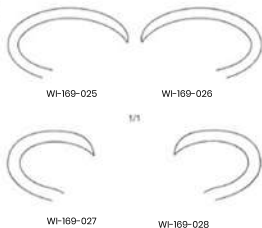

Lambotte
WI-169-029-WI-169-032
20 cm / 8 1/4"

10mm
WI-169-029
15mm
WI-169-030
20 mm
WI-169-031
25mm
WI-169-032

Bone Surgery Periosteal Raspatories



1/2

1/2

WI-170-033
17.5 cm / 7"



WI-170-034
21.0 cm / 8 1/4"



WI-170-035
17.5 cm / 7"



WI-170-036
21.0 cm / 8 1/4"



WI-170-031
20.5 cm / 8"

Semb
WI-170-033-WI-170-037

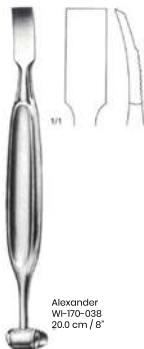

1/2

Alexander
WI-170-038
20.0 cm / 8"

1/1



1/2

Matson
WI-170-039
22.0 cm / 8 3/4"



1/1

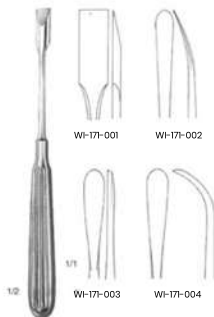

WI-171-001

WI-171-002

WI-171-003

WI-171-004

Adson
WI-171-001-WI-171-004
17.0 cm / 6 3/4"

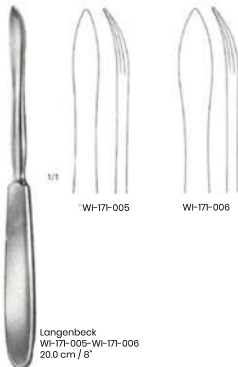

WI-171-005

WI-171-006

Langenbeck
WI-171-005-WI-171-006
20.0 cm / 8"



Williger
WI-171-007
17.0 cm / 6 3/4"

Williger
WI-171-008
16.0 cm / 6 1/4"

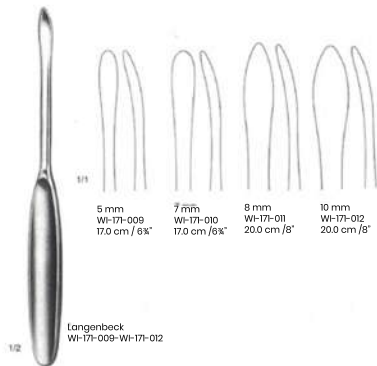

5 mm
WI-171-009
17.0 cm / 6 3/4"

7 mm
WI-171-010
17.0 cm / 6 3/4"

8 mm
WI-171-011
20.0 cm / 8"

10 mm
WI-171-012
20.0 cm / 8"

Langenbeck
WI-171-009-WI-171-012



WI-172-013
17.5 cm / 6 3/4"

extremely lightweight



Micro Elevator
WI-172-014
16.0 cm / 6 1/4"

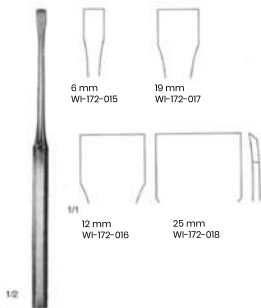

Key
WI-172-015-WI-172-018
19.0 cm / 7 1/2"



WI-172-019
16.0 cm / 6 3/4"



Alderdyce
WI-172-020
21.0 cm / 8 1/4"



Mcdonald
WI-172-021
19.0 cm / 7 1/2"

Bone Surgery Bone Levers

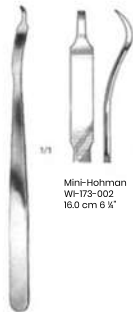
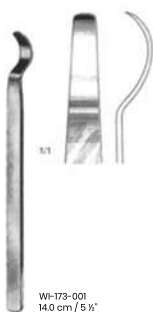

Bone Surgery Bone Levers

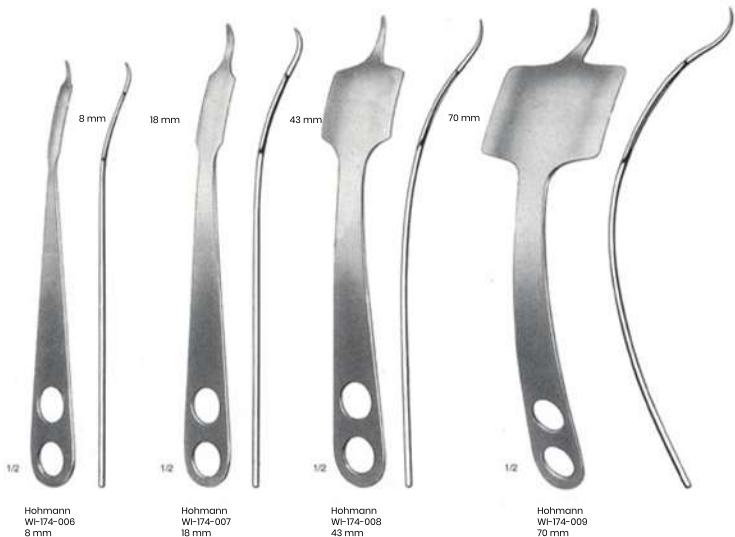

Bone Surgery Bone Levers

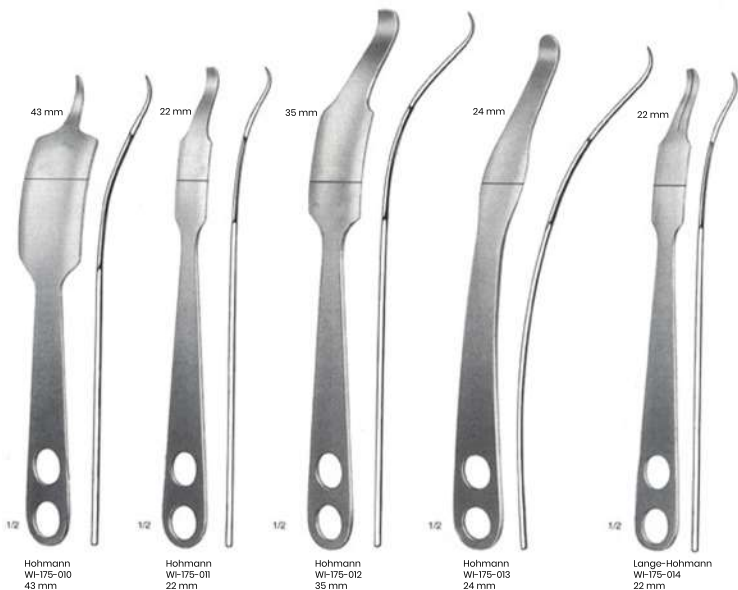

Bone Surgery Bone Levers and Spinal Retractors



Bennett
WI-175-015
24.0 cm / 9 1/2"



Blount
WI-175-016
26.0 cm / 10 1/4"



Blount
WI-175-017
26.0 cm / 10 1/4"

Spinal Retractor

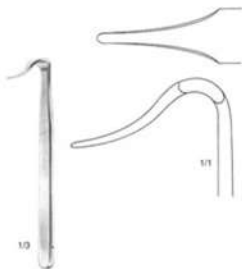

Blount kneeol Retractors
WI-175-018
17.5 cm / 7"

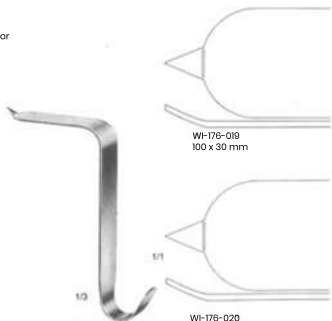

WI-176-019
100 x 30 mm

WI-176-020
Taylor Spinal Retractors 75 x 30 mm
WI-175-019-WI-175-020
16.5 cm / 6 1/2"
100 x 30 mm 75 x 30 mm

Bone Surgery Menisectomy Knives

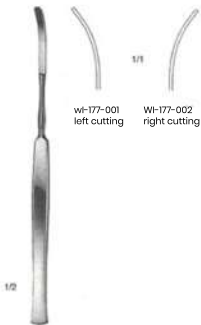

WI-177-001
left cutting

WI-177-002
right cutting

Mod. Schweden
WI-177-001-WI-177-002
17.0 cm / 6 3/4"

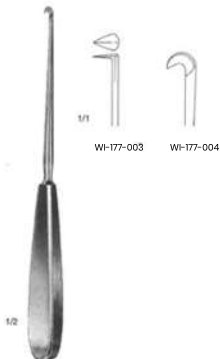

WI-177-003

WI-177-004

Bircher
WI-177-003-WI-177-004
19.0 cm / 7 1/2"

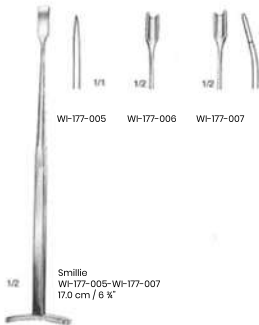

WI-177-005

WI-177-006

WI-177-007

Smillie
WI-177-005-WI-177-007
17.0 cm / 6 3/4"

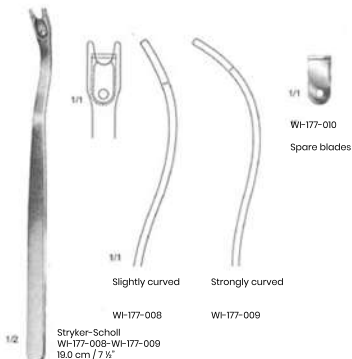

Slightly curved

Strongly curved

WI-177-008

WI-177-009

Stryker-Scholl
WI-177-008-WI-177-009
19.0 cm / 7 1/2"

WI-177-010
Spare blades

Bone Surgery Bone Holding Forceps



WI-178-001
13.5 cm / 5 1/4"



Dingmann
WI-178-002
19.0cm / 7 1/2"



Special Model
WI-178-003
19.0cm / 7 1/2"



WI-178-004
12.0 cm / 4 3/4"



Lowin
WI-178-005
17.5 cm / 7"

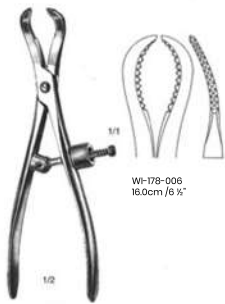

WI-178-006-WI-178-007



WI-178-006
16.0cm / 6 1/4"

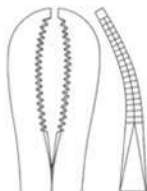

WI-178-007
24.0cm / 9 1/2"

Bone Surgery Bone Holding Forceps



WI-179-008
14.0 cm / 5½"



WI-179-009
13.5 cm / 5¼"



Langenbeck
WI-179-010
21.0 cm / 8¼"

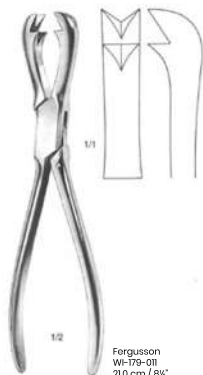

Fergusson
WI-179-011
21.0 cm / 8¼"



Frosch
WI-179-012
18.0 cm / 7"



WI-179-013
20.0 cm / 8"

Bone Surgery Bone Holding Forceps

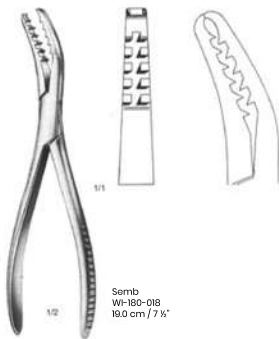
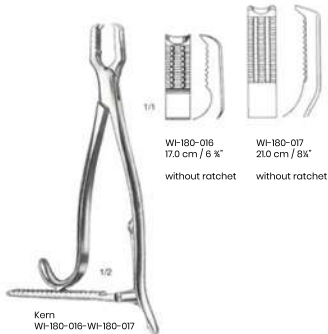
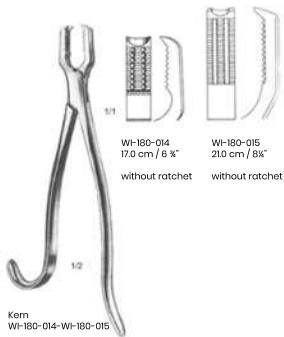

Bone Surgery Bone Holding Forceps



Farebeuf
WF-181-001- 23.0 cm / 9"
WF-181-002- 26.0 cm / 10 1/4"

Farebeuf-Lambotto
WF-181-003
26.0 cm / 10 1/4"

Tuffler
WF-181-004
27.0 cm / 10 1/2"

Bone Surgery Bone Holding Forceps



Lambotte
 WI-182-005 - 22.0 cm / 8 5/8"
 WI-182-006 - 27.0 cm / 10 1/2"
 WI-182-007 - 30.0 cm / 12"

Lambotte
 WI-182-008 - 22.0 cm / 8 5/8"
 WI-182-009 - 26.0 cm / 10 1/8"
 WI-182-010 - 33.0 cm / 13"

Lambotte
 WI-182-011 - 19.0 cm / 7 1/2"
 WI-182-012 - 23.0 cm / 9"
 WI-182-013 - 26.0 cm / 10 1/4"

Bone Surgery Bone Holding Forceps

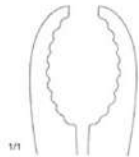

WI-018-014
23.0 cm / 9"

WI-018-015
25.0 cm / 10"

WI-018-016
28.0 cm / 11"

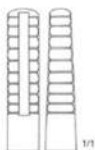

Ulrich
WI-018-014- WI-018-016



Ulrich
WI-018-017
28.0 cm / 11"

Bone Surgery Bone Holding Forceps

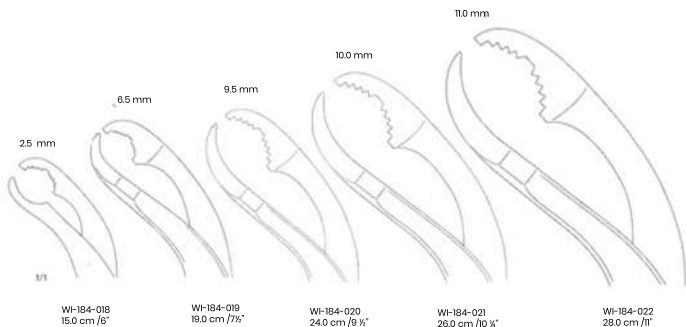

Self-centering forceps
with thread fixation



WI-184-018- WI-184-022

Bone Surgery Bone Holding Forceps



Lane
WI-185-023-WI-185-026

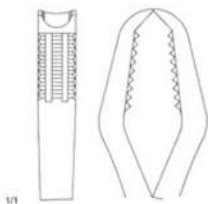

WI-185-023
33.0 cm / 13"

Without ratchet

WI-185-024
33.0 cm / 13"
With ratchet

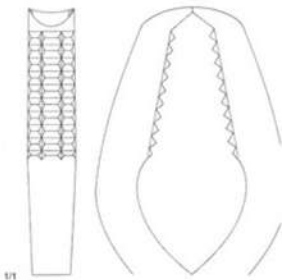

WI-185-025
45.0 cm / 17"

Without ratchet

WI-185-026
45.0 cm / 17"
With ratchet

Bone Surgery Bone Holding Forceps, Retractors



vebrugge
WI-186-027-WI-186-029

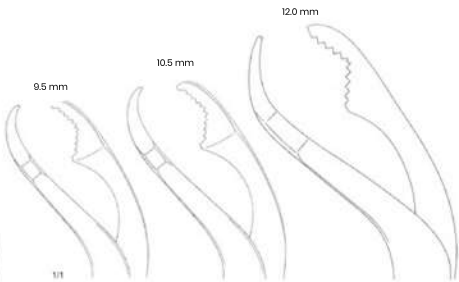

WI-186-027
25.0 cm / 10"

WI-186-028
26.0 cm / 10 1/4"

WI-186-029
27.0 cm / 11"



Verbrugge
WI-186-030
17.5 cm / 7"

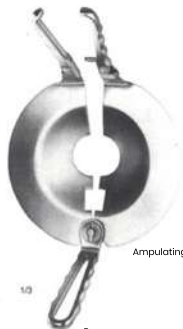

Ampulating Retractor

Percy
WI-186-031

Bone Surgery Bone Rongeur Forceps

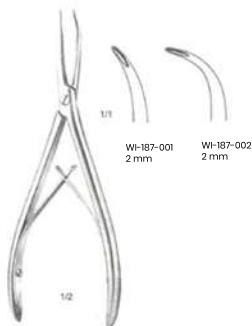

WI-187-001
2 mm

WI-187-002
2 mm

Stellbrink
WI-187-001-WI-187-002
17.0 cm / 6 3/4"



Mini-Friedman
WI-187-003
13.0 cm / 5"



Friedman
WI-187-004
14.0 cm / 5 1/2"



Cleveland
WI-187-007
14.0 cm / 5 1/2"



Cleveland
WI-187-006
17.0 cm / 6 3/4"



Universal
WI-187-007
13.5 cm / 5 1/4"



Mead
WI-187-008
16.5 cm / 6 1/2"

Bone Surgery Bone Rongeur Forceps

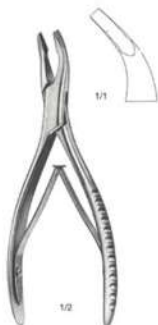

Mead
WI-188-009
16.5 cm / 6 1/2"



Hartmann
WI-188-010
18.5 cm / 7 1/4"

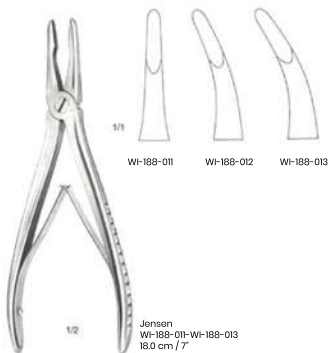

Jensen
WI-188-011-WI-188-013
18.0 cm / 7"

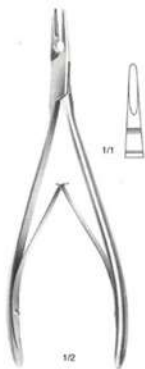

Lempert
WI-188-014
19.0 cm / 7 1/2"

Bone Surgery Bone Rongeur Forceps

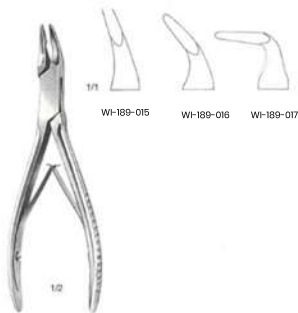

WI-189-015

WI-189-016

WI-189-017

Blumenthal
WI-189-015-WI-189-017

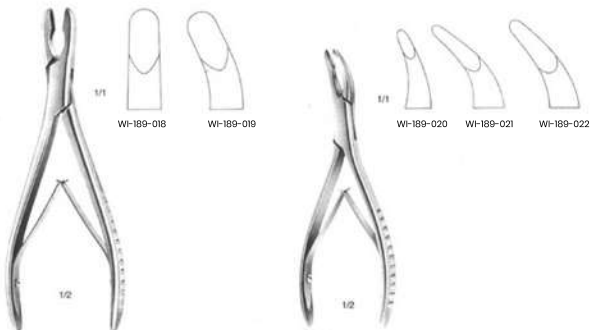

WI-189-018

WI-189-019

WI-189-020

WI-189-021

WI-189-022

Lour
WI-189-018-WI-189-019
17.0 cm / 6 3/4"

Lour
WI-189-020-WI-189-022
15.0 cm / 6"

Bone Surgery Bone Rongeur Forceps



Bohler
Wi-190-023-Wi-190-024



Wi-190-024



Beyer
Wi-190-025
18.0 cm / 7"



Zaufat-Janson
Wi-190-025
18.0 cm / 7"



Mayfield
Wi-190-027
17.0 cm / 6 3/4"



Marquardt
Wi-190-028
20.0 cm / 8"



Ruskin
Wi-190-029
18.0 cm / 7"



Ruskin
Wi-190-030
23.0 cm / 9"

Bone Surgery Bone Rongeur Forceps

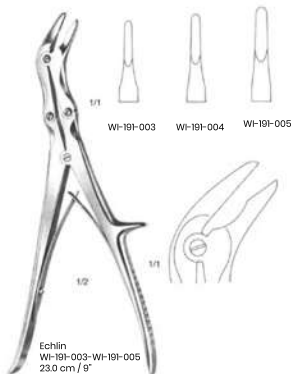

Bone Surgery Bone Rongeur Forceps

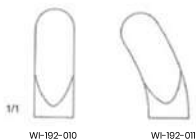
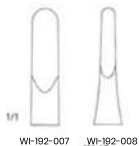

Leksoff-Stille
WI-192-007-WI-192-008
24.0 cm / 9 1/2"



Frykholm
WI-192-009
24.0 cm / 9 1/2"



Stille-Luer
WI-192-0107-WI-192-011
22.0 cm / 8 5/8"

Bone Surgery Bone Rongeur Forceps

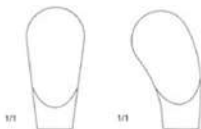

WI-193-012 - 23.0 cm / 9"
WI-193-013 - 27.0 cm / 10 1/2"

WI-193-014 - 23.0 cm / 9"
WI-193-015 - 27.0 cm / 10 1/2"

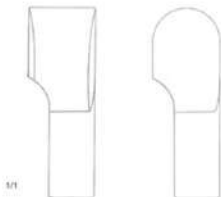

WI-193-016

WI-193-017



Stille-Luer
WI-193-012 - WI-193-015



Suerbruch
WI-193-016 - WI-193-017
30.0 cm / 12"

Bone Surgery Bone Cutting Forceps



Markwalder
WI-194-001
20.0 cm / 8"



Cottle-Kanzjian
WI-194-002
19.0 cm / 7½"



WI-194-003
14.0 cm / 5½"

WI-194-004
17.0 cm / 6¾"

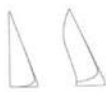

WI-194-007
14.0 cm / 5½"

WI-194-002
17.0 cm / 6¾"



Liston
WI-194-003-WI-194-006



WI-194-005
19.0 cm / 7½"

WI-194-006
22.0 cm / 8¾"



Liston
WI-194-007-WI-194-010

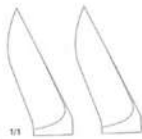

WI-194-009
19.0 cm / 7½"

WI-194-010
22.0 cm / 8¾"

Bone Surgery Bone Cutting Forceps



Cleveland
WI-195-011
17.0 cm / 6 3/4"



Cleveland
WI-195-012
15.0 cm / 6"



WI-195-013
12.0 cm / 4 3/4"

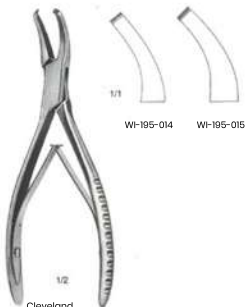

Cleveland
WI-195-014-WI-195-015
16.0 cm / 6 1/4"

Bone Surgery Bone Cutting Forceps

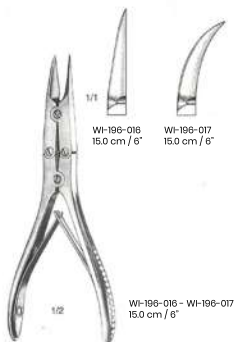

Bone Surgery Bone Cutting Forceps

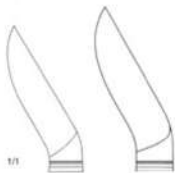

WI-197-023
23.0 cm / 9 1/4"

WI-197-024
27.0 cm / 10 1/2"



Stille-Liston
WI-197-021
27.0 cm / 10 1/2"



Stille-Liston
WI-197-022
27.0 cm / 10 1/2"



Liston-Key
WI-197-023-WI-197-024



Liston-Key
WI-198-025
27.0 cm / 10 1/2"



Semb
WI-198-026
24.0 cm / 9 1/2"

Bone Surgery Nail Instruments, Finger Ring Saws



Special Model
WI-199-001
17.0 cm / 6 3/4"



Walton
WI-199-003
16.0 cm / 6 1/4"



WI-199-005
17.0 cm / 6 3/4"

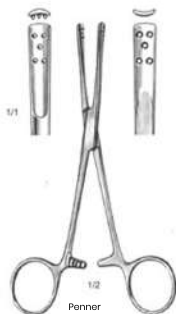

Penner
WI-199-007
15.5 cm / 6"



Radolf
WI-199-008
13.5 cm / 5 1/4"

Bone Surgery Amputating and Resection Saws



Spare saw blade

WI-200-004- 12.0 mm
WI-200-005 - 15.0 mm



Charriere
WI-200-003
35.0 cm / 14"



Spare saw blade

WI-200-004- 3 mm
WI-200-005 - 5 mm
WI-200-006 - 7 mm



Helferich-Bior
WI-200-007
39.0 cm / 15 1/2"



1/2

Lindemann
WI-200-008
20.0 cm / 8"



1/2

Langenbeck
WI-200-009
23.0 cm / 9"



1/4

Charriere
WI-200-010- 27 cm / 10 1/2"
WI-200-010- 30 cm / 12"



1/4

Sattorie
WI-200-012
31.0 cm / 12 1/2"

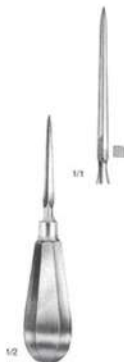

WI-201-001
14.0cm / 5 1/2"



Perthes
WI-201-002
20.0cm / 8 1/4"



WI-201-003
14.0cm / 5 1/2"

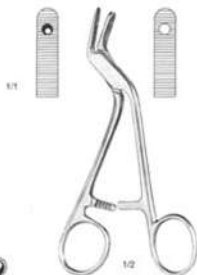

Adson
WI-201-004
15.0cm / 6"



WI-202-006



WI-202-007
9 mm Ø



WI-202-008
14 mm Ø



WI-202-009
16 mm Ø



WI-202-010
22 mm Ø



Hudson
WI-202-005
27.0 cm / 10 1/8"



Cushing
WI-202-011
14 mm Ø



WI-202-012
2 mm Ø



Mckenzie
WI-202-013
13 mm Ø



Ericc
WI-202-014
16mm Ø

* Hand Drill, with 4 burrs fig. 7-10 and extension piece fig. 6

Bone Surgery Bone Holding Clamps

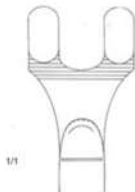
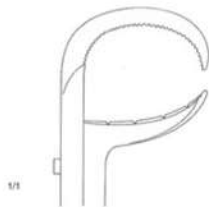

WI-203-002
18.0 cm / 7"



WI-203-003
20.0 cm / 8"

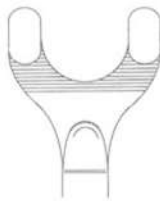

WI-203-004
22.0 cm / 8 3/4"

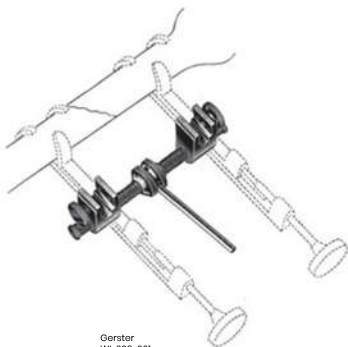

Gerster
WI-203-001



Gerster-Lowmann
WI-203-002-WI-203-004

Bone Surgery Flat Nose Pliers, Wire Cutting Pliers, Seizing Forceps



WI-204-001
16.0 cm / 6 1/2"



WI-204-002
16.0 cm / 6 1/2"



WI-204-003
17.0 cm / 6 1/2"



WI-204-004
18.0 cm / 7"

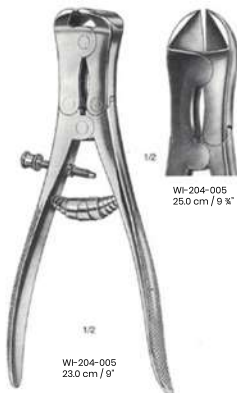

WI-204-005
25.0 cm / 9 3/4"



WI-204-007
15.0 cm / 6"

TUNGSTEN CARBIDE

Bone Surgery Flat Nose Pliers



WI-205-08



WI-205-09



WI-205-010

TUNGSTEN CARBIDE
GOLD PLATED

1/2

WI-205-008-WI-205-010
18.0 CM / 7"

1/2



WI-205-011



WI-205-012



Parallel Action

1/2

WI-205-008-WI-205-012
18.0 CM / 7"



WI-205-013
14.0 cm / 6 1/2"

1/2



with groove

WI-205-014
16.0 cm / 6 3/4"

1/2



WI-205-015



WI-205-016

1/2

WI-205-015-WI-205-016
17.0 cm / 6 3/4"

Bone Surgery
Bone and Wire Cutting
Pliers Tungsten Carbide
Inserts



GOLD PLATED

WI-206-002
 16.0 cm / 6 1/4"



Diamant
 WI-206-002
 16.0 cm / 6 1/4"



for hard wires up to 1.6 mm Ø
 for soft wires up to 2.0 mm Ø

GOLD PLATED

WI-206-003
 16.0 cm / 5 1/4"



for wires up to 2.5 mm Ø

WI-206-004
 22.0 cm / 8 1/4"

Bone Surgery
Wire Cutting Pliers
Tungsten Carbide
Inserts



G O L D P L A T E D



WI-207-005
15.0 cm / 6"



WI-207-006
24.0 cm / 9 1/2"



WI-207-007
18.0 cm / 7"



for soft wires
up to 2 mm Ø



for soft wires
up to 15 mm Ø

Bone Surgery Extension Bows



with 3 traction hooks

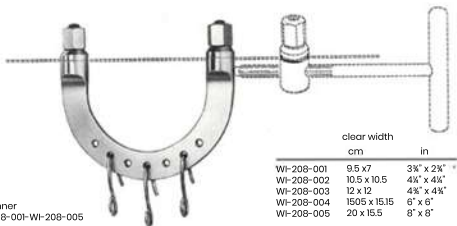

Kirschner
WI-208-001-WI-208-005

| | clear width | |
|------------|---------------|-------------------|
| | cm | in |
| WI-208-001 | 9.5 x 7 | 3 3/4" x 2 3/4" * |
| WI-208-002 | 10.5 x 10.5 | 4 1/4" x 4 1/4" |
| WI-208-003 | 12 x 12 | 4 3/4" x 4 3/4" |
| WI-208-004 | 15.05 x 15.15 | 6" x 6" |
| WI-208-005 | 20 x 15.5 | 8" x 8" |

with 3 traction hooks

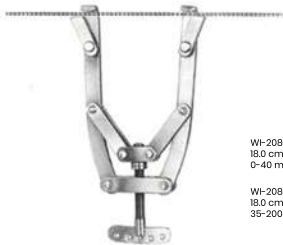

WI-208-007
18.0 cm / 7 1/4"
0-40 mm

WI-208-008
18.0 cm / 10 1/4"
35-200 mm

with 3 traction hooks



Kirschner
WI-208-006
6 x 6 cm 2 1/2" x 2"

Kirschner
WI-208-007-WI-208-008

Bone Surgery Extension Bows



WI-209-009



WI-209-010
19.0 cm / 3/4"



WI-209-011-WF-209-012

| | clear width | |
|------------|-------------|------------------|
| | cm | in |
| WI-209-011 | 18 x 10 | 7" x 4" |
| WI-208-012 | 27 x 27 | 10 1/2" x 6 1/4" |

Wire gauze, sterilizable



WI-209-013
Small

WI-209-014
Medium

WI-209-015
Large

WI-209-013-WI-209-015

Fixation Disks for Wire Drills



WI-209-016
Pair

WI-209-009

WI-209-010

- Wire Strainer for Kirschner extension bows
WI-208-001-WI-208_005
- Screw Nut Wrench for
WI-208-001-WI-208_005



WI-209-017

WI-209-018



WI-210-001
14.0 cm / 5 1/2"



WI-210-002 - 14.0 cm / 5 1/2"
WI-210-003 - 16.0 cm / 6 1/4"



Turnbull
WI-210-004 - 11 1/2 cm / 4 1/2"
WI-210-005 - 13.0 cm / 5"



WI-210-006
13.0 cm / 5"

Asepsis Cuticle Nippers, Cuticle Scissors



WI-21I-007
12.0 cm / 4 1/2"



WI-21I-008 - 11.0 cm / 4 1/4"
WI-21I-009 - 13.0 cm / 5"
WI-21I-010 - 15.0 cm / 6"

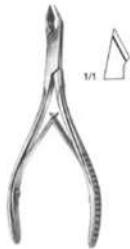

WI-21I-011 - 11.0 cm / 4 1/4"
WI-21I-012 - 13.0 cm / 5"



WI-21I-013
10.5 cm / 4 1/4"



Cohen
WI-21I-014
13.0 cm / 5"



Cohen
WI-21I-015
13.0 cm / 5"

Sterilization Iodine and Sterilizing Forceps



1/1

WI-212-001
20.0 cm / 8"

*Iodine Forceps
of acrylic glass



1/3

Cheatie
WI-212-002
27.0 cm / 10½"

*Sterilizing Forceps



1/3

WI-212-003
30.0 cm / 12"



1/3

Rogge
WI-212-004
23.0 cm / 9"



1/3

Pyo-Smith (Harrison)
WI-212-005
30.0 cm / 12"

General Instruments Retractors

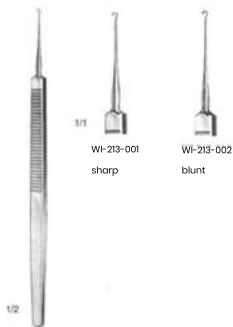

WI-213-001
sharp

WI-213-002
blunt

Graefe
WI-213-001-WI-213-002
16.0 cm / 6 1/4"

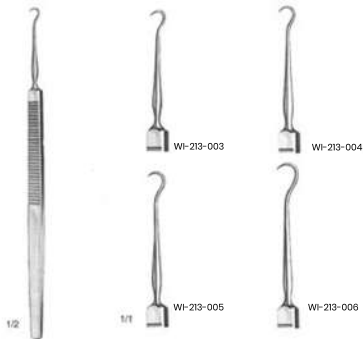

WI-213-003

WI-213-004

WI-213-005

WI-213-006

Graefe
WI-213-003-WI-213-006
16.0 cm / 6 1/4"



O'Connor
WI-213-007
16.0 cm / 6 1/4"

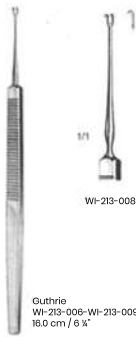

Guthrie
WI-213-006-WI-213-009
16.0 cm / 6 1/4"

General Instruments Retractors

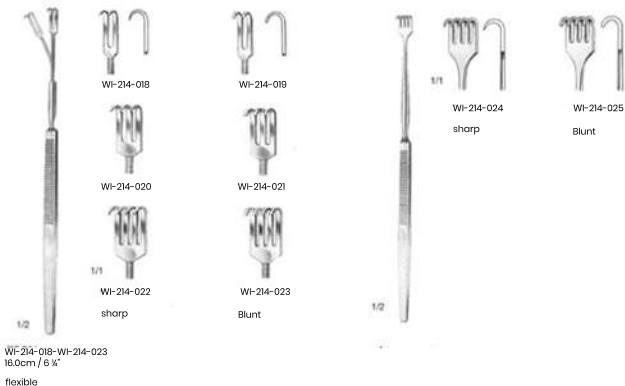
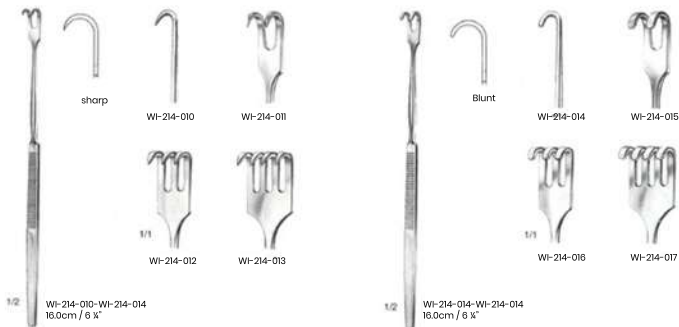

General Instruments Retractors



WI-215-001
12.0 cm / 4 1/2"

*Micro retractor with saddle blade, buttoned



Desmarros
WI-215-002-WI-215-007
16.0cm / 6 1/4"



WI-215-008-WI-215-011
16.0cm / 6 1/4"



Mini-Langenbeck
WI-215-012-WI-215-015
16.0cm / 6 1/4"

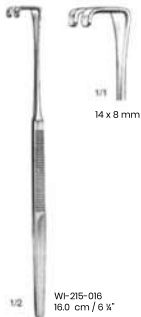

General Instruments Retractors

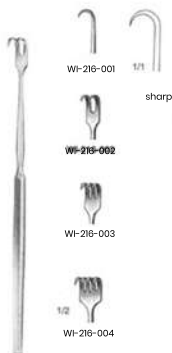

WI-216-001

1/1

sharp

WI-216-002

WI-216-003

WI-216-004

1/2

WI-216-001-WI-216-004
16.0 cm / 6 1/4"

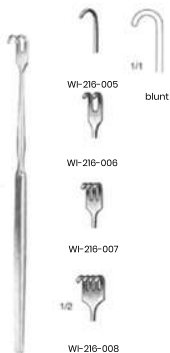

WI-216-005

1/1

blunt

WI-216-006

WI-216-007

WI-216-008

1/2

WI-216-005-WI-216-008
16.0 cm / 6 1/4"

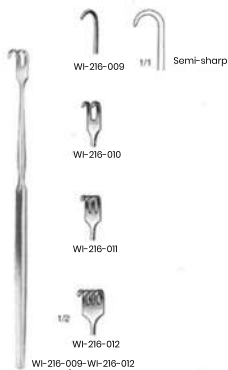

WI-216-009

1/1

Semi-sharp

WI-216-010

WI-216-011

WI-216-012

1/2

WI-216-009-WI-216-012
16.0 cm / 6 1/4"



WI-216-013
18 x 7 mm

WI-216-014
16 x 5 mm

WI-216-015
7 x 4 mm

WI-216-016
10 x 3 mm

WI-216-017
7 x 4 mm

WI-216-018
10 x 4 mm

Meyarding
WI-216-013-WI-216-018
18.0 cm / 7"

General Instruments Retractors



WI-217-001
20 x 6 mm

WI-217-002
10 x 6 mm

1/2

Senn-Green
WI-217-001-WI-217-002
15.0 cm / 6"



1/1
8 x 4 mm

15 x 5.5 mm

1/2

Ragnell-Davis
WI-217-003
14.0 cm / 5 1/2"

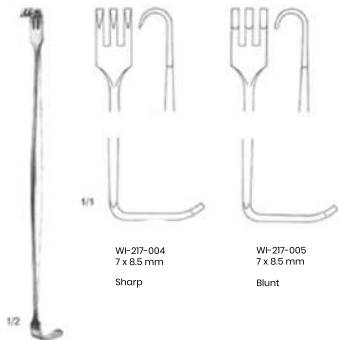

WI-217-004
7 x 8.5 mm

Sharp

WI-217-005
7 x 8.5 mm

Blunt

1/2

Senn-Mueller
WI_217-004-WI-217-005
16.0 cm / 6 1/4"

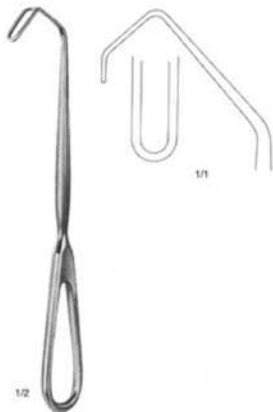

1/2

Cushing
WI-217-006
20.0 cm / 8"

General Instruments Retractors

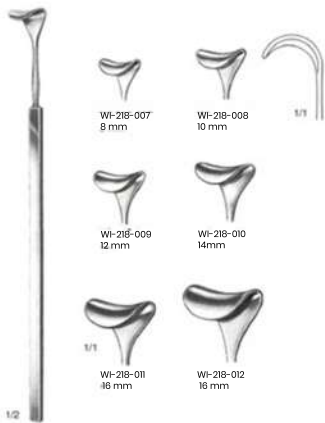

Cushing
WI-218-007-WI-218-012
20.0 cm . 8"

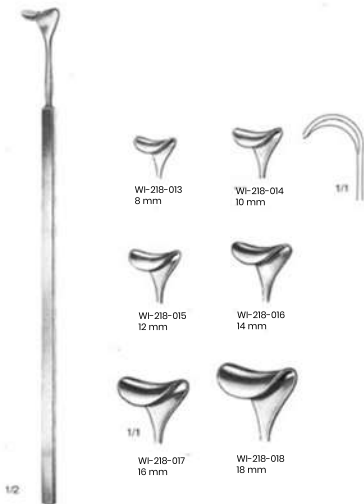

Cushing
WI-218-013-WI-218-018
24.0 cm . 9 1/2"

General Instruments Retractors



WI-219-001



WI-219-002

Venenhaken Bron
WI-219-001-WI-219-002
19.0 cm / 7 1/2"



WI-219-003



WI-219-004
toothed

Strandell-Stille
WI-219-003-WI-219-004
19.0 cm / 7 1/2"



sharp

1/1

WI-219-005



WI-219-006



WI-219-007



WI-219-008



WI-219-009



blunt

WI-219-010



WI-219-011



WI-219-012



WI-219-013

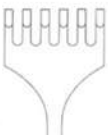

WI-219-014

Volkman
WI-219-005-WI-219-014
23.0 cm / 9"

1/1

General Instruments Retractors



WI-220-001



WI-220-002



WI-220-003



WI-220-004



WI-220-005



sharp



WI-220-006



WI-220-007



WI-220-008



WI-220-009



WI-220-010



blunt



WI-220-011



WI-220-012



WI-220-013



WI-220-014



WI-220-015



semi-sharp



1/2

Volkman
WI-22-001-WI-220-019
21.5 cm / 8 1/2"



Volkman
WI-22-016
21.5 cm / 8 1/2"



Volkman
WI-22-017
21.5 cm / 8 1/2"



WI-220-018
20.0 cm / 8"
sharp

WI-220-019
20.0 cm / 8"
blunt

General Instruments Retractors



Kocher
WI-221-001-WI-221-018
22.0 cm / 8 3/4"

General Instruments Retractors



Special Model[®]
WI-222-001-WI-22-08
22.0 cm / 8 3/4"



WI-222-001



WI-222-002



WI-222-003



WI-222-004



1/1

sharp



WI-222-005



WI-222-006



WI-222-007



WI-222-008



1/1

blunt



1/1



1/1



WL_223-002
36 x 60 mm



33 x 20 mm



WL_223-004
40x 30 mm

sharp



WL_223-005
40x 30 mm
blunt



1/2

WL_223-001
36 x 30 mm

1/2

Ollier
WL_223-001-WL-223-002
22.5 cm / 9"

1/2

Wassmund
WL_223-003
20.0 cm / 8"

1/2

Koerte
WL_223-004-WL-223-005
23.5 cm / 9 1/4"

General Instruments Retractors



WI-224-006
40 x 40 mm



WI-224-007
45 x 50 mm



WI-224-008
50 x 60 mm

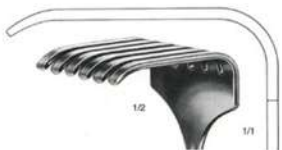

WI-224-009
70 x 70 mm



1/2

Israel
WI-224-006-WI-224-009
25.0 cm / 10"

General Instruments Retractors



1/2

Langenbeck
WI-225-WI-225-005
22.0 cm / 8 $\frac{1}{2}$ "



1/2

Langenbeck
WI-225-WI-225-010
21.0 cm / 8 $\frac{1}{4}$ "



WI-225-001
WI-225-006
30 x 11 mm



WI-225-002
WI-225-007
30 x 17 mm



WI-225-003
WI-225-008
30 x 16 mm

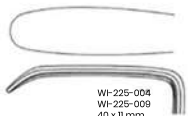

WI-225-004
WI-225-009
40 x 11 mm

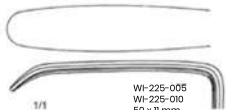

1/1

WI-225-005
WI-225-010
50 x 11 mm

General Instruments Retractors



60 x 20 mm

1/1

1/2

Langenbeck
WI-226-01
210 cm / 8 1/4"

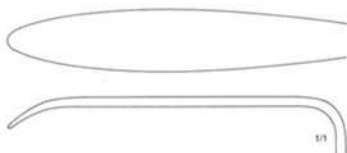

85 x 15 mm

1/1

1/2

Langenbeck
WI-226-02
210 cm / 8 1/4"

General Instruments Retractors



Kocher
WI-227-013- WI-227-017
23.0 cm / 9"



WI-227-013
40 x 18 mm



WI-227-014
60 x 20 mm



WI-227-015
80 x 25 mm



WI-227-016
75 x 30 mm



WI-227-017
75 x 40 mm

General Instruments Retractors



1/2

Kocher-Langenbeck
WI-228-018-WI-228-026
21.5 cm / 8 1/2"

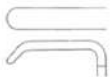

WI-228-018
26 x 6 mm



WI-228-019
35 x 8 mm



WI-228-020
35 x 11 mm



WI-228-021
35 x 15 mm



WI-228-022
40 x 11 mm



WI-228-023
50 x 11 mm



WI-228-024
70 x 14 mm



WI-228-025
80 x 12 mm



WI-228-026
80 x 16 mm

General Instruments Retractors

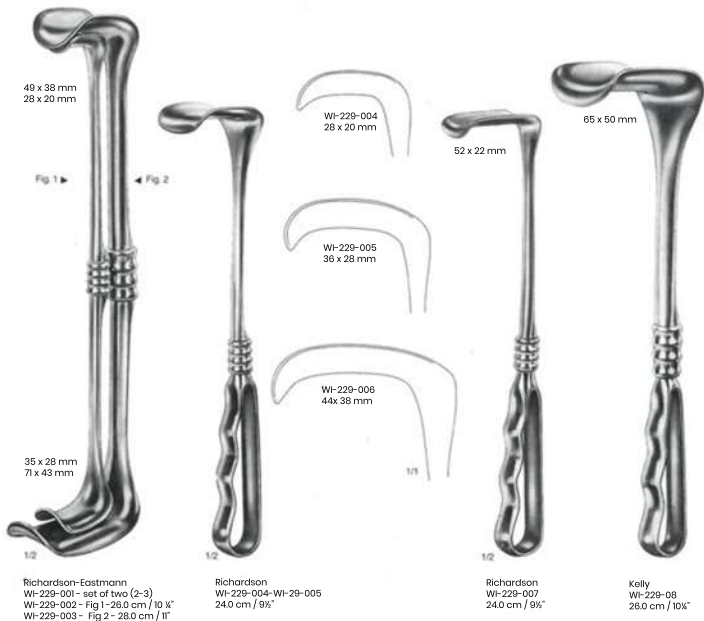

General Instruments Retractors



50 x 85 mm

1/2

Doyen
WI-230-001
25.0 cm / 10"



1/2

Doyen
WI-230-002
25.0 cm / 10"



70 x 25 mm

1/2

Kocher
WI-230-003
22.5 cm / 9"

1/2

Kocher
WI-230-004-WI-230-006
25.0 cm / 10"

WI-230-004- 80 x 45 mm
WI-230-005- 80 x 55 mm
WI-230-006- 80 x 65 mm

General Instruments Retractors



Brunner
WI-231-001 - WI-231-007
25 cm / 10"

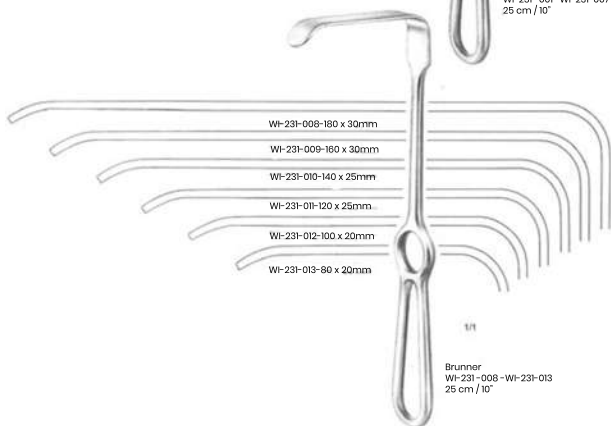

Brunner
WI-231-008 - WI-231-013
25 cm / 10"

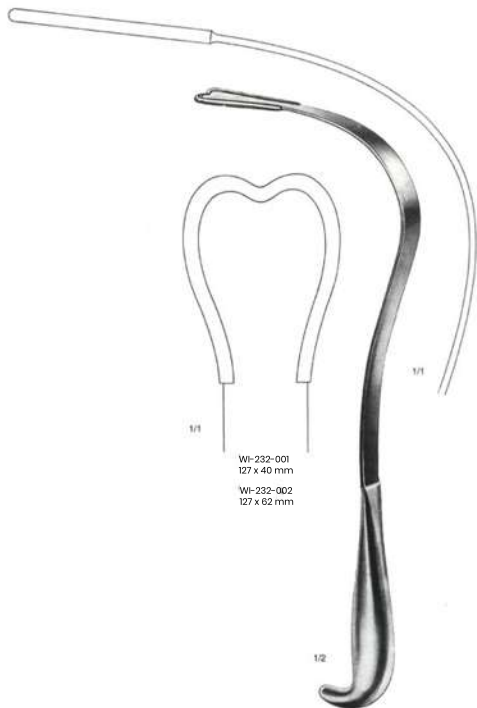

WI-232-001
127 x 40 mm

WI-232-002
127 x 62 mm

Harrington
WI-232-001 - WI-232-002
32.0 cm / 12 1/2"

General Instruments Retractors





1/2

Deaver
WI-234-007
30.0 cm / 12"



1/2

Deaver
WI-234-008
30.0 cm / 12"



1/2

Deaver
WI-234-009
30.0 cm / 12"

General Instruments Retractors



25 mm
WI-235-010



1/2

Deaver
WI-235-010-WI-235-013
31.0 cm / 12 1/4"



38 mm
WI-235-011



50 mm
WI-235-012

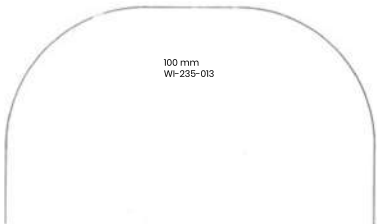

100 mm
WI-235-013

1/1

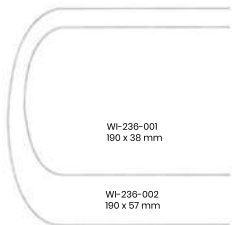

WI-236-001
190 x 38 mm

WI-236-002
190 x 57 mm



Kally
WI-236-001-WI-236-02
27.0 cm / 10 5/8"

1/2

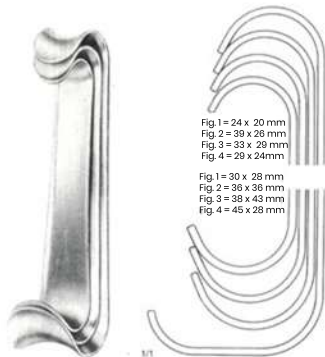

Fig. 1 = 24 x 20 mm
Fig. 2 = 39 x 26 mm
Fig. 3 = 33 x 29 mm
Fig. 4 = 29 x 24mm

Fig. 1 = 30 x 28 mm
Fig. 2 = 36 x 36 mm
Fig. 3 = 38 x 43 mm
Fig. 4 = 45 x 28 mm

3/1

Roux
WI-236-003-set of three-fig.1-3)
WI-236-004-Fig. 1 = 14.0 cm / 5 1/2"
WI-236-005-Fig. 2 = 15.0 cm / 6"
WI-236-006-Fig. 3 = 17.0 cm / 6 3/4"
WI-236-007-Fig. 4 = 18.0 cm / 7"

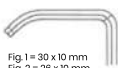

Fig. 1 = 30 x 10 mm
Fig. 2 = 26 x 10 mm

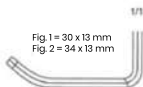

Fig. 1 = 30 x 13 mm
Fig. 2 = 34 x 13 mm

Farabeuf
WI-237-008 -set of two
12.0 cm / 4 3/4"



Fig. 1 = 27 x 16 mm
Fig. 2 = 23 x 16 mm

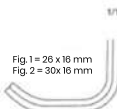
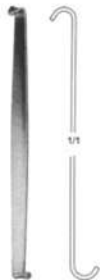

Fig. 1 = 26 x 16 mm
Fig. 2 = 30 x 16 mm

Farabeuf
WI-237-009 -set of two
15.0 cm / 6"



1/1

Mini-Roux
WI-237-010
14.0 cm / 5 1/2"

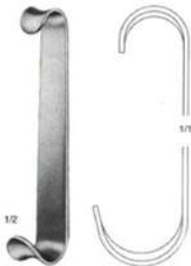

1/1

Baby-Roux
WI-237-011
13.5 cm / 5 1/4"

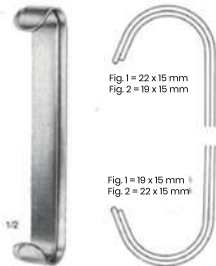

1/2

Fig. 1 = 22 x 15 mm
Fig. 2 = 19 x 15 mm

Fig. 1 = 19 x 15 mm
Fig. 2 = 22 x 15 mm

Parker
WI-237-012-set of two
13.5 cm / 5 1/4"

General Instruments Retractors



Fig. 1 = 26 x 25 mm
Fig. 2 = 29 x 25 mm

1/2

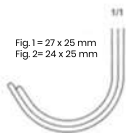

Fig. 1 = 27 x 25 mm
Fig. 2 = 24 x 25 mm

Parker
WI-238-013-Set of two
18.0 cm / 7"



1/2

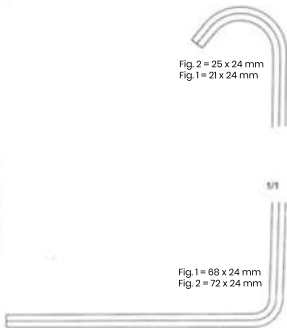
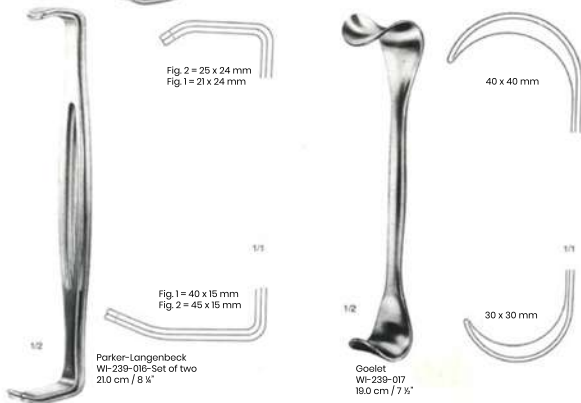
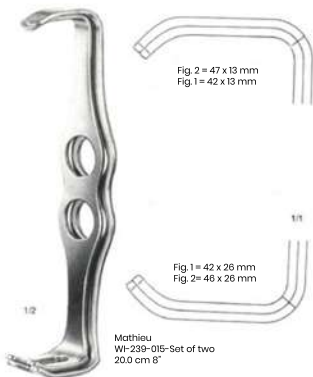

Fig. 2 = 25 x 24 mm
Fig. 1 = 21 x 24 mm

1/1

Fig. 1 = 68 x 24 mm
Fig. 2 = 72 x 24 mm

Parker-Mott
WI-238-014-Set of two
16.0 cm / 6 1/4"



General Instruments Retractors



Finson
WI-240-001-WI-240-004
7.0 cm / 2"
3 x 4 teeth



WI-240-001
Sharp



WI-240-002
Blunt



WI-240-003
Sharp



WI-240-004
Blunt



Special Model
WI-240-005-WI-240-006
7.0 cm / 2 3/4"
3 x 4 teeth



WI-240-005
sharp



WI-240-006
blunt



Logan
WI-240-007
4.0 cm / 1 1/2"
3 x 3 teeth

General Instruments Retractors



Buckfiby
WI-241-008
6.0 cm / 2 3/4"
3 x 3 teeth
Sharp



WI-241-009
8.0 cm / 3 1/4"
3 x 3 teeth



WI-241-010
10.0 cm / 4"
4 x 4 teeth
Blunt

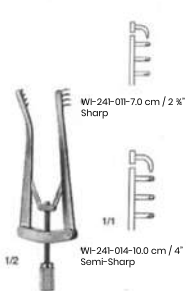

Alm
WI-241-011-WI-241-015
4 x 4 teeth

WI-241-011-7.0 cm / 2 7/8"
Sharp



WI-241-012-10.0 cm / 4"
Sharp



WI-241-013-7.0 cm / 2 7/8"
Blunt



WI-241-014-10.0 cm / 4"
Semi-Sharp



WI-241-015-10.0 cm / 4"
Blunt



1/2

Jansen
WI-242-016-WI-242-018
10.0 cm / 4"
3 x 3 teeth



1/1

WI-242-016
Sharp



WI-242-017
with 1 Sharp and 2 blunt prongs each



WI-242-018
Blunt



1/2

Scalp Contour
WI-242-019-WI-242-020
14.0 cm / 5 1/2"
3 x 4 teeth

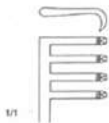

1/1

WI-242-019
Sharp



WI-242-020
blunt



Anderson-Adson
WI-243-001
19.5 cm / 7 3/4"
4 x 4 teeth

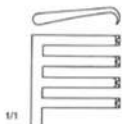

Weltlaner
WI-243-002-WI-243-003
20.0 cm / 8"



WI-243-002
Sharp



WI-243-003
Blunt

General Instruments Retractors



80 mm



Adson
WI-244-004-WI-244-007
28.0 cm / 10 1/2"

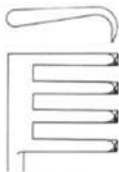

WI-244-004
3 x 4 teeth
sharp

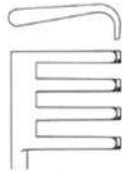

WI-244-005
3 x 4 teeth
blunt

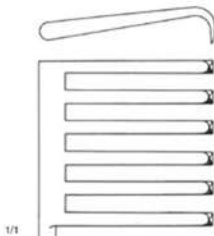



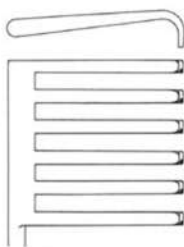









WI-244-006
6 x 6 teeth
sharp

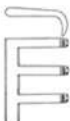

WI-244-007
3 x 4 teeth
blunt

General Instruments Retractors



| | | | | |
|---|--|---|--|--|
|  <p>35 mm</p> <p>1/2</p> <p>Weltaner-Loktite WI-245-008-WI-245-009 10.5 cm / 4"</p> |  <p>WI-245-008 2 x 3 teeth Sharp</p>  <p>1/1</p> <p>WI-245-009 2 x 3 teeth blunt</p> | <p>5 mm 80 mm</p>  <p>1/2</p> <p>WI-245-010-13.0 cm / 5" 3 x 4 teeth Sharp</p> <p>WI-245-011-13.0 cm / 5" 3 x 4 teeth blunt</p> <p>WI-245-010-WI-245-013</p> |  <p>WI-245-010-13.0 cm / 5" 3 x 4 teeth Sharp</p>  <p>1/1</p> <p>WI-245-011-13.0 cm / 5" 3 x 4 teeth blunt</p> |  <p>WI-245-012-16.5 cm / 6 1/2" 3 x 4 teeth Sharp</p>  <p>1/1</p> <p>WI-245-013-16.5 cm / 6 1/2" 3 x 4 teeth blunt</p> |
| <p>50 mm</p>  <p>1/2</p> <p>Weltaner-Wullstein WI-245-014-WI-245-015 13.0 cm / 5"</p> |  <p>WI-245-014 Sharp</p>  <p>1/1</p> <p>WI-245-015 blunt</p> |  <p>1/2</p> <p>Millison WI-245-016 15.0 cm / 6"</p>  <p>1/1</p> <p>sharp</p> | | |

General Instruments Retractors

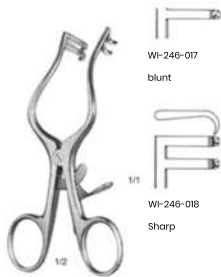

WI-246-017

blunt



WI-246-018

Sharp

Plester
WI-246-017-WI-246-018
13.0 cm / 5"
2 x 2 teeth



Plester
WI-246-019
11.0 cm / 4 1/4"
2 teeth
blunt



Plester
WI-246-020
11.0 cm / 4 1/4"
2 teeth
blunt

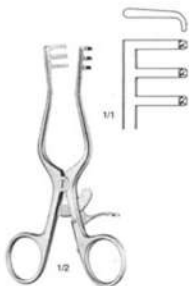

Milligan
WI-246-021
13.0 cm / 5"

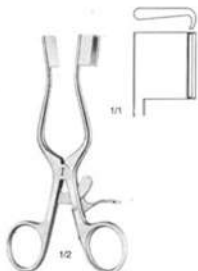

Weltlaner-Baby
WI-246-022
13.0 cm / 5"

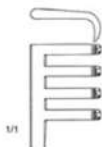

WI-247-001
Sharp

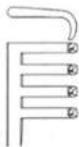

WI-247-002
Blunt



1/2

Honley
WI-247-001-WI-247-002
16.5cm / 6 1/2"
3 x 4 teeth



1/2

WI-247-003
16mm x 19 mm
3/4" x 3/4"



WI-247-004
16mm x 25 mm
3/4" x 1"



WI-247-005
16mm x 32 mm
3/4" x 1 1/4"



Adson
WI-248-001- WI-248-008
3 x 4 teeth



WI-248-001
13.0 cm / 5"



WI-248-002
13.0 cm / 5"

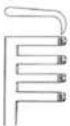

WI-248-003
16.0 cm / 6 1/4"



WI-248-004
16.0 cm / 6 1/4"



WI-248-005
20.0 cm / 8"



WI-248-006
20.0 cm / 8"

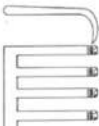

WI-248-007
26.0 cm / 10 1/4"
sharp



WI-248-008
26.0 cm / 10 1/4"
Blunt



E X C H A N G E B L A D E S



Cloward
WI-249-001 Retractor without blades
25.0 cm / 10"
WI-249-002 Retractor complete with two blades
25.0 cm / 10"



Beckmann
WI-250-001
31.0 cm 12 1/2"
4 x 4 teeth

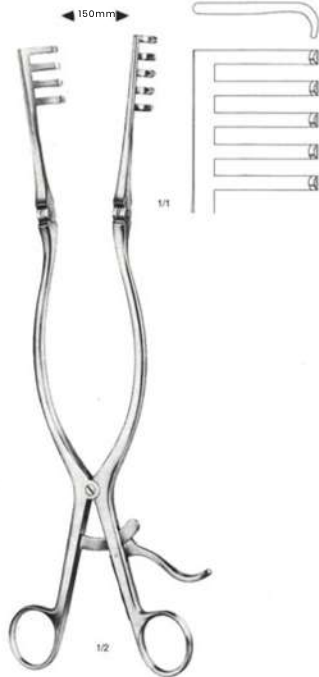

Adson
WI-250-002
32.0 cm 12 1/2"
4 x 5 teeth



Beckmann-Adson
WI-251-03 - WI-251-06
31.0 cm / 12 1/4"
4 x 4 teeth

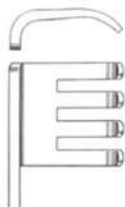

WI-251-003
blunt

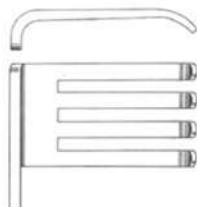

WI-251-004
blunt

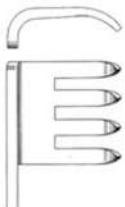

WI-251-005
sharp



WI-251-006
sharp



Beckmann-Eaton
WI-252-007
32.0 cm / 12 1/2"

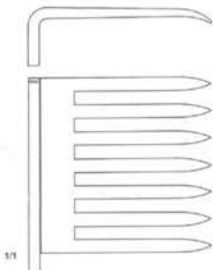



Hemi-Laminectomy
WI-253-008 - WI-253-009
270 cm / 10 5/8"
6 x 6 teeth

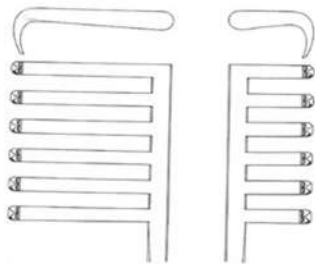

WI-253-008

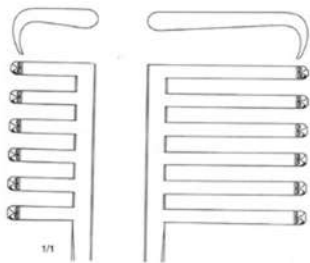

WI-253-009

Bone Surgery Retractors



Darling
WI-254-010
18.0 cm / 7"
(Paplitea)

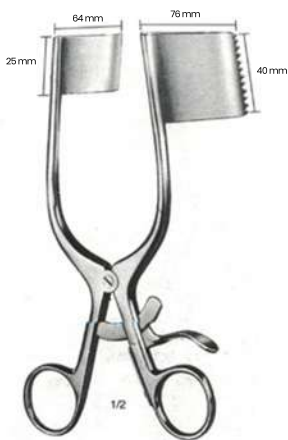

Darling
WI-254-011
18.0 cm / 7"
(Paplitea)



Gelpi-Loktite
WI-255-012
130 cm / 5"

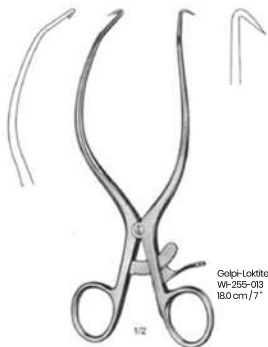

Gelpi-Loktite
WI-255-013
180 cm / 7"



Gelpi-Loktite
WI-255-014
180 cm / 7"



Gelpi-Loktite
WI-255-015
150 cm / 6"



E X C H A N G A B L E B L A D E S

Measurements of blades: Depth x width

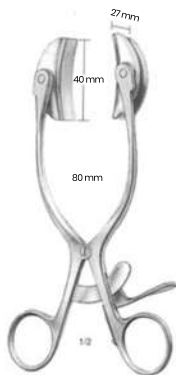

Baby-Collin
WF-256-001

complete, with 2 pairs of blades

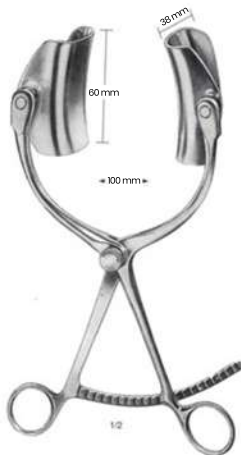

Collin
WF-256-002

complete, with 1 pair of blades 38 x 60 mm

Bone Surgery Abdominal Retractors

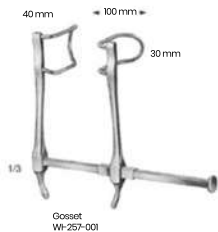

Gosset
W-257-001



Gosset
W-257-002

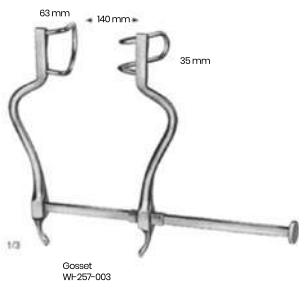

Gosset
W-257-003

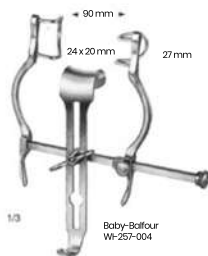

Baby-Balfour
W-257-004

Bone Surgery Abdominal Retractors

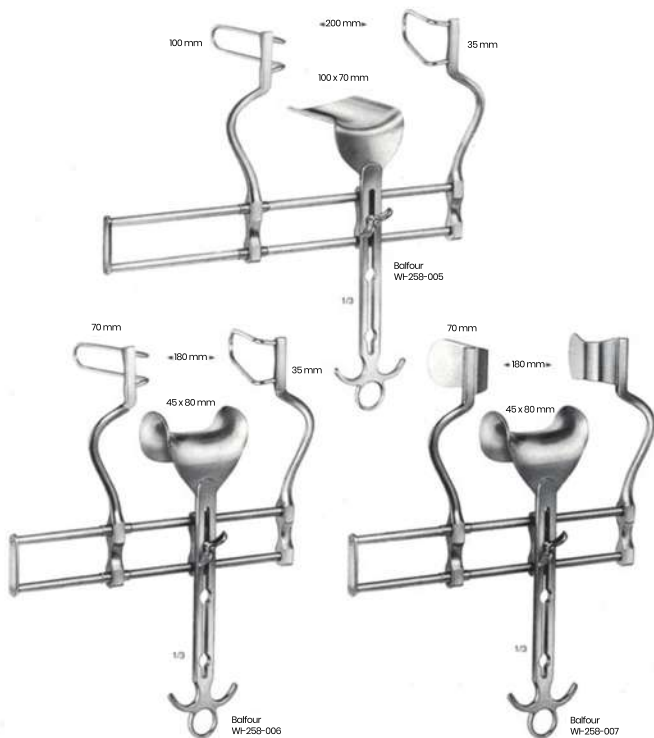

Bone Surgery Abdominal Retractors

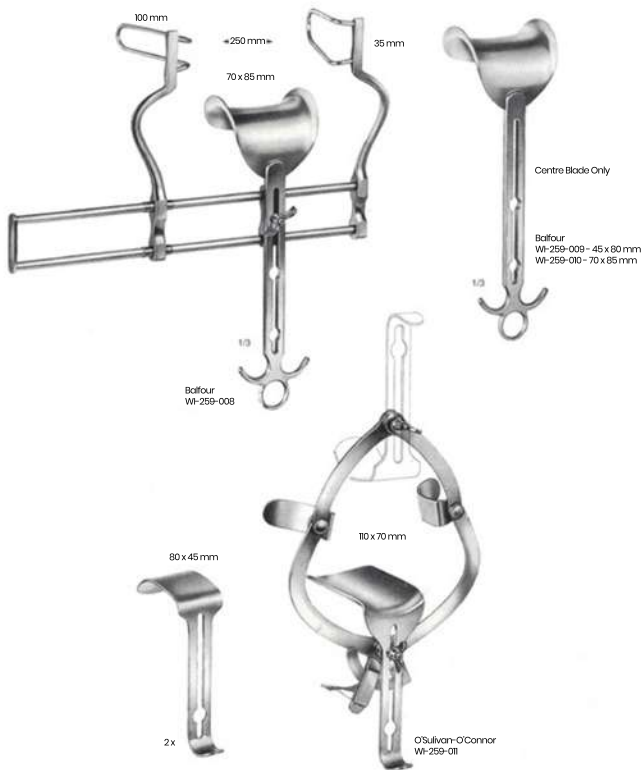

Bone Surgery Abdominal Spatulas



Reverdin
Wf-260-001
28.0 cm / 11"



Ribbon
Wf-260-002 - 33.0 cm / 13", 30 mm
Wf-260-003 - 33.0 cm / 13", 40 mm
Wf-260-004 - 33.0 cm / 13", 50 mm

flexible



Haberer
Wf-260-005 - 20.0 cm / 8", 17/25 mm
Wf-260-006 - 28.0 cm / 11", 25/30 mm
Wf-260-007 - 30.0 cm / 12", 37/45 mm

flexibles



Special Model Soft
Wf-260-008 - 20.0 cm x 12 mm
Wf-260-009 - 20.0 cm x 17 mm
Wf-260-010 - 25.0 cm x 25 mm

malleable and very soft

Wf-260-011 - 20.0 cm x 6.5 mm
Wf-260-012 - 20.0 cm x 9.5 mm
Wf-260-013 - 20.0 cm x 13 mm
Wf-260-014 - 20.0 cm x 16 mm
Wf-260-015 - 20.0 cm x 19 mm
Wf-260-016 - 20.0 cm x 25 mm



WI-261-001

WI-261-002

WI-261-003



WI-261-004

WI-261-005

WI-261-006



Goldsmith (Thudichum)
WI-261-001 - WI-261-003



Voltoini
WI-261-004 - WI-261-006



Schwarz
WI-261-007
14.0 cm / 5 1/2"



Hartmann-Holle
WI-261-008 - WI-261-010
15.0 cm / 6"

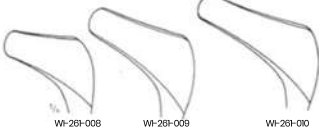

WI-261-008

WI-261-009

WI-261-010

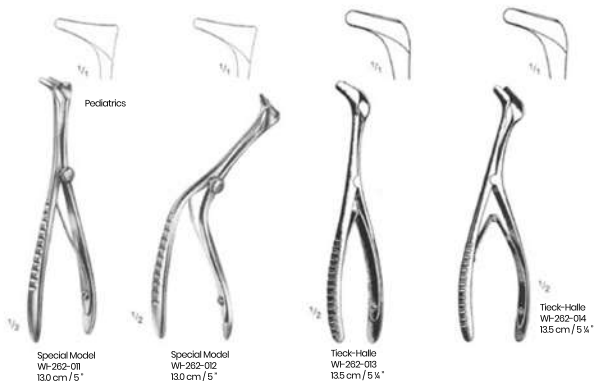

Tick-Halle
WF-262-014
13.5 cm / 5 1/4"

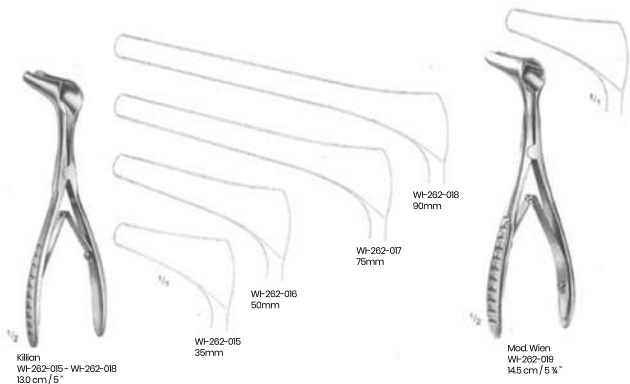



Cottle
WI-263-020 - WI-263-023
15.0 cm / 6"

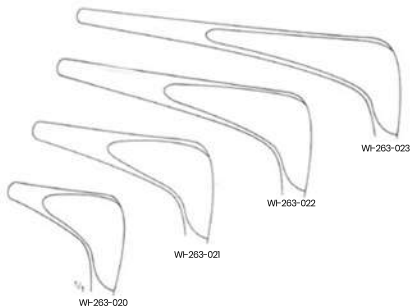

WI-263-023

WI-263-022

WI-263-021

WI-263-020



Cottle
WI-263-024 - WI-263-025
14.0 cm / 5 1/2"

Dull black
chromium
plated

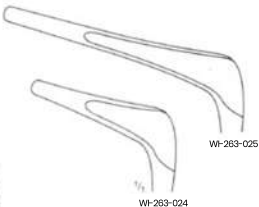

WI-263-025

WI-263-024



Yankauer
WI-263-026
13.0 cm / 7 1/4"

Rhinology Dressing and Tampon Forceps, Nasal Polypus Forceps



Troeltsch
WI-264-001
15.0cm / 6"

Troeltsch
WI-264-002
18.0cm / 7"



Gruenwald (Jansen)
WI-264-003
20.0cm / 8"



Westmacott
WI-264-004
20.0cm / 8"



Lubet-Barbon
WI-264-005
20.0cm / 8"



Hartmann
WI-264-006
16.0cm / 6 1/4"



Heymann
WI-264-007
18.0cm / 7"

Rhinology

Nasal Polypus and Septum

Compression forceps



Hartmann
Wf-265-006
20.0 cm / 8"



Littauer
Wf-265-009
18.0 cm / 7"



Killian
Wf-265-010
17.0 cm / 6 1/2"



Wf-265-012



Heymann
Wf-265-012 - Wf-265-014
18.0 cm / 7"



Wf-265-013



Wf-265-014



Quire
Wf-265-011
12.0 cm / 4 1/2"



Knight
Wf-265-015
18.0 cm / 7"

Rhinology

Nasal Polypus and Septum

Compression forceps



Craig
WF-266-016
18.0cm / 7"



WF-266-017 WF-266-018
18.0cm / 7"



WF-266-019 WF-266-020
Luc
WF-266-019 - WF-266-020
20.0cm / 8"

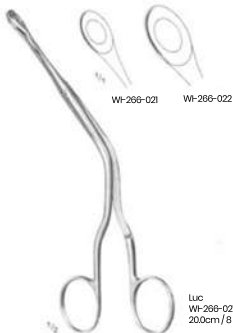

WF-266-021 WF-266-022
Luc
WF-266-021 - WF-266-022
20.0cm / 8"



WF-266-023 WF-266-024 WF-266-025 WF-266-026
Bruonings
WF-266-023 - WF-266-026
19.0cm / 7 1/2"



Takahashi
WI-267-001 - WI-267-002
19.0cm / 7 1/2"



WI-267-001



WI-267-002



Weil
WI-267-003

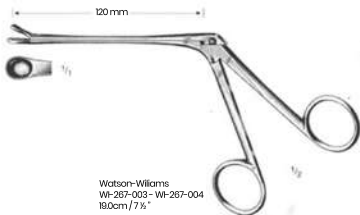

Watson-Williams
WI-267-003 - WI-267-004
19.0cm / 7 1/2"



WI-267-004

Rhinology Nasal Cutting Forceps



without neck



WI-268-005



WI-268-006



WI-268-007



WI-268-008



WI-268-009



with neck



WI-268-010



WI-268-011



WI-268-012



WI-268-013



WI-268-014

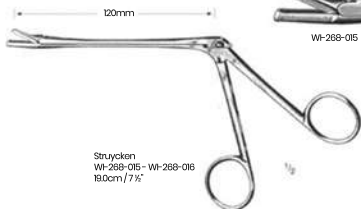
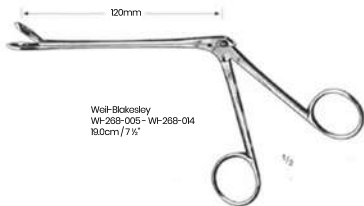

WI-268-015



WI-268-016

Rhinology Nasal Cutting Forceps



WI-269-017
2.2mm

WI-269-018
2.6mm

WI-269-019
3.0mm

WI-269-020
3.4mm

WI-269-021

WI-269-022

WI-269-023



120mm

WI-269-017 - WI-269-020

1/4

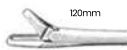

120mm

Myles
WI-269-021 - WI-269-023
19.0cm / 7 1/2"



120mm

Hojek
WI-269-024
19.0cm / 7 1/2"

WI-269-025
5.0mm

WI-269-026
7.0mm

WI-269-027
9.0mm

WI-269-028
11.0mm



120mm

Hartman
WI-269-025 - WI-269-028
19.0cm / 7 1/2"

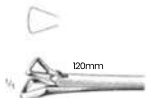

120mm

Schmeden
WI-269-029
19.0cm / 7 1/2"



120mm

Rhinology Septum Compression Forceps



Jansen-Struycken
WI-270-001
19.0cm / 7½"



Middleton-Jansen
WI-270-002
19.0cm / 7½"



Middleton-Jansen
WI-270-003
19.0cm / 7½"



Caplan
Wt-27-004
20.0cm / 8"

Septumscissors serrated



Killian
Wt-27-005
21.0cm / 8 1/2"

Septumscissors serrated



Rubin
Wt-27-006
21.0cm / 8 1/2"

Septum morselizer



Wt-27-007

Rhinology

Sphenoid Punches, Antrum Punch Forceps



Wt-272-01 - Wt-272-04

4 x 4 mm Hajek Wt-272-001

4 x 4 mm Hajek Wt-272-002

3.5 x 3.5 mm Hajek-Kofler Wt-272-003

3.5 x 3.5 mm Hajek-Kofler Wt-272-004

3 x 5 mm Wt-272-005

3 x 5 mm Wt-272-006

5 x 5 mm Wt-272-007

5 x 5 mm Wt-272-008

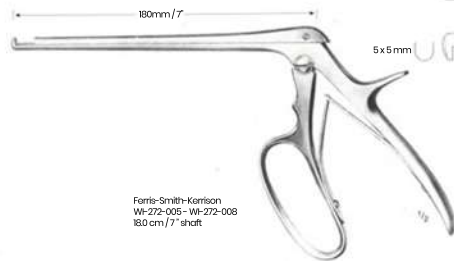

Ferris-Smith-Karrison
Wt-272-005 - Wt-272-008
18.0 cm / 7" shaft

Rhinology

Sphenoid Punches and Rongeur Forceps

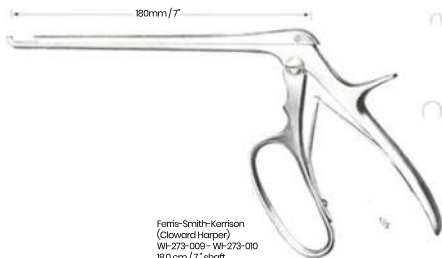

Ferris-Smith-Kerrison
(Cloward Harper)
Wt-273-009 - Wt-273-010
18.0 cm / 7" shaft



Wt-273-009 = 3 mm

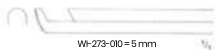

Wt-273-010 = 5 mm

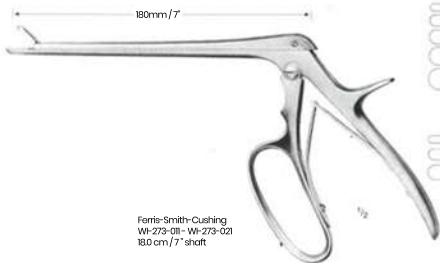

Ferris-Smith-Cushing
Wt-273-011 - Wt-273-021
18.0 cm / 7" shaft



curved up

Wt-273-011 = 2 x 10 mm

Wt-273-012 = 3 x 10 mm

Wt-273-013 = 4 x 10 mm



straight

Wt-273-014 = 2 x 10 mm

Wt-273-015 = 3 x 10 mm

Wt-273-016 = 4 x 10 mm

Wt-273-017 = 5 x 10 mm

Wt-273-018 = 6 x 10 mm

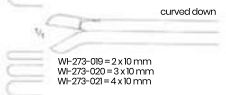

curved down

Wt-273-019 = 2 x 10 mm

Wt-273-020 = 3 x 10 mm

Wt-273-021 = 4 x 10 mm

Rhinology Sphenoid Punches, Antrum Punch Forceps



4 x 4 mm  Wf-274-023 = 4 mm

5 x 5 mm  Wf-274-024 = 5 mm

6 x 6 mm  Wf-274-025 = 6 mm



Hajpek-Claus
Wf-274-022
20.0cm / 8"



Kerrison
Wf-274-023 - Wf-274-025
20.0cm / 8"



Joseph
WI-275-001 - WI-275-004



WI-275-001



WI-275-002

Straight



WI-275-003



WI-275-004

Curved



Forman
WI-275-005
16.0 cm / 6 1/4"



Converse
WI-275-006
16.0 cm / 6 1/4"



Joseph
WI-275-007
15.0 cm / 6"



Cottle
WI-275-008
15.0 cm / 6"



Cottle
WI-275-009
15.0 cm / 6"



Joseph
WI-275-001 - WI-275-004



WI-275-001



WI-275-002

Straight



WI-275-003



WI-275-004

Curved



Forman
WI-275-005
16.0 cm / 6 1/4"



Converse
WI-275-006
16.0 cm / 6 1/4"



Joseph
WI-275-007
15.0 cm / 6"



Cottle
WI-275-008
15.0 cm / 6"



Cottle
WI-275-009
15.0 cm / 6"

Rhinology Septum Elevators



Wt-277-001
4 mm



Wt-277-002
5 mm



McKenty
Wt-277-001 - Wt-277-002



Halle
Wt-277-003
16.5 cm / 6 1/2"



Joseph
Wt-277-004
16.5 cm / 6 1/2"



Fræur
Wt-277-005
19.0 cm / 7 1/2"

sharp



Fræur
Wt-277-006
19.0 cm / 7 1/2"

blunt



Fræur
Wt-277-007
18.0 cm / 7"

sharp-blunt



sharp

blunt



Fræur
Wt-277-008
20.5 cm / 8"

Rhinology Septum and Periosteal Elevators



McKenty
WI-278-009
22.0 cm / 8 1/2"

Cottle
WI-278-010
23.0 cm / 9"

Kilian
WI-278-011
18.0 cm / 7"

Kilian
WI-278-012
22.0 cm / 8 1/2"

Pierce
WI-278-013
21.0 cm / 8 1/4"

Ponnington
WI-278-014
21.0 cm / 8 1/4"

Rogor
WI-278-015
19.0 cm / 7 1/2"

Rhinology Septum and Periosteal Elevators



Carter
WI-279-016
21.0 cm / 8 1/4"



Joseph-Masing
WI-279-017
22.0 cm / 8 1/2"



Cottle
WI-279-018
22.0 cm / 8 3/4"



Masing
WI-279-019
21.0 cm / 8 1/4"



Cottle
WI-279-020
21.0 cm / 8 1/4"



Joseph
WI-279-021
18.0 cm / 6 3/4"



Wt-280-001
4 mm



Wt-280-002
4 mm



Freer
Wt-280-003
4 mm



Freer
Wt-280-004
4 mm



Freer
Wt-280-005
6 mm



Killian
Wt-280-006
5 mm
17.0 cm / 6 3/4"



Killian-Claus
Wt-280-007
5 mm
17.0 cm / 6 3/4"

Freer
Wt-280-001 - Wt-280-002
18.0 cm / 7 1/8"

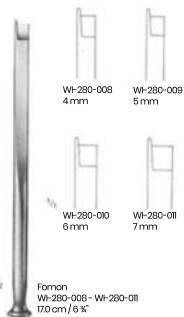

Wt-280-008
4 mm

Wt-280-009
5 mm

Wt-280-010
6 mm

Wt-280-011
7 mm

Fomen
Wt-280-008 - Wt-280-011
17.0 cm / 6 3/4"

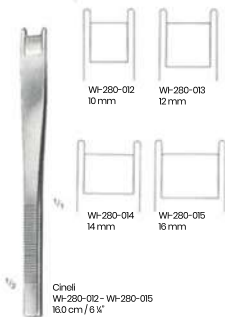

Wt-280-012
10 mm

Wt-280-013
12 mm

Wt-280-014
14 mm

Wt-280-015
16 mm

Cinell
Wt-280-012 - Wt-280-015
18.0 cm / 6 3/4"

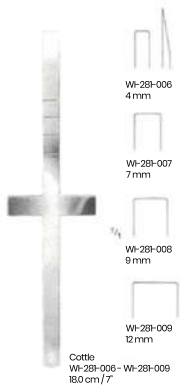
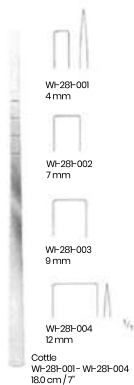

Rhinology Rhinoplastic Instruments ETC.



Sheehan
Wf-282-001 - Wf-282-004
17.0 cm / 6 3/4"



Wf-282-001
7 mm



Wf-282-002
8 mm



Wf-282-003
10 mm



Wf-282-004
12 mm



Wf-282-005



Wf-282-006



Wf-282-007



Silver
Wf-282-005 - Wf-282-007
18.0 cm / 7"

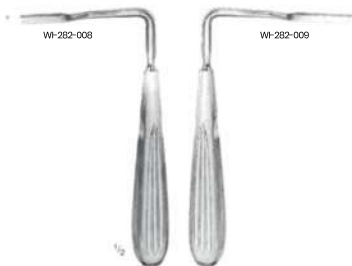

Wf-282-008

Wf-282-009

Joseph
Wf-282-008 - Wf-282-009
17.0 cm / 6 3/4"



Joseph
Wf-282-010 - Wf-282-012
19.0 cm / 6 3/4"



Wf-282-010



Wf-282-011



Wf-282-012

Rhinology Rhinoplastic Instruments ETC.



Maltz
WI-283-001
18.0 cm / 7"



Joseph
WI-283-002
18.0 cm / 6 1/2"

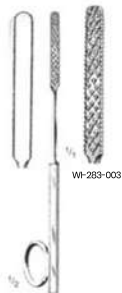

Galleher
WI-283-003 - WI-283-005
16.0 cm / 6 1/4"



WI-283-004



WI-283-005



Cottle
WI-283-006
21.0 cm / 8 1/4"

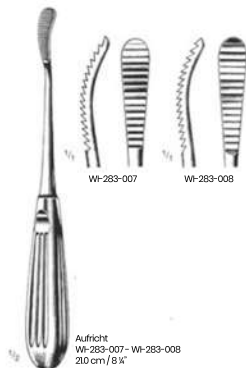

Aufrecht
WI-283-007 - WI-283-008
21.0 cm / 8 1/4"

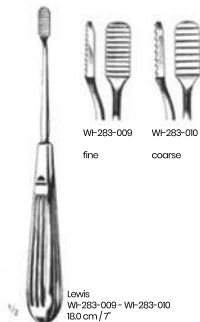

Lewis
WI-283-009 - WI-283-010
18.0 cm / 7"

WI-283-009

WI-283-010

fine

coarse



Joseph
WI-284-001
15.0 cm / 6"



Cottle
WI-284-002
16.0 cm / 6 1/4"



WI-284-003 - WI-284-005
15.0 cm / 6"



WI-284-003



WI-284-004



WI-284-005



Lange
WI-284-006
22.0 cm / 8 1/2"



Forman
WI-284-007
17.0 cm / 6 3/4"



Aufrecht
WI-284-008
19.0 cm / 7 1/2"



Kilner
WI-284-009
10.0 cm / 4"



Converse
WI-284-010
12.0 cm / 4 1/4"



Freer
WI-284-011
15.0 cm / 6"

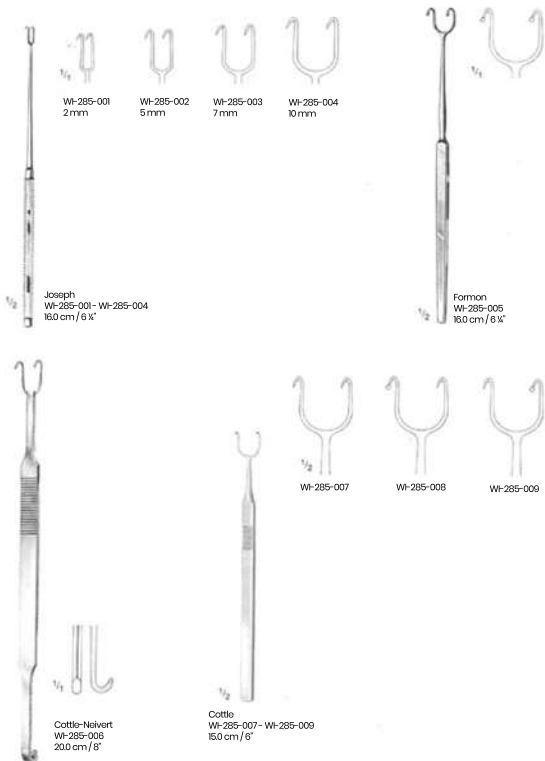



Cottle
WI-286-001
14.0 cm / 5 1/2"



Noivert
WI-286-002
16.0 cm / 6 1/4"



Cottle
WI-286-003
15.0 cm / 6"



Cottle
WI-286-004
15.0 cm / 6"



Aufrecht
WI-286-005
13.5 cm / 5 1/4"



Yankauer (Septum Suture Needles)
WI-286-006 - WI-286-014



WI-286-006



WI-286-007



WI-286-008



WI-286-009



WI-286-010



WI-286-011



WI-286-012



WI-286-013



WI-286-014



WI-287-002



WI-287-003



WI-287-004



WI-287-005



Krossner
WI-287-001
20.0 cm / 8"



Cottle-Walsham
WI-287-002 - WI-287-004
23.0 cm / 9"



Asch
WI-287-005
23.0 cm / 9"



Prapp
WI-288-001
210 cm / 8 1/4"



Foulkner
WI-288-002
210 cm / 8 1/4"



Cockley
WI-288-003 - WI-288-008
170 cm / 6 3/4"



WI-288-003



WI-288-004



WI-288-005



WI-288-006



WI-288-007



WI-288-008



WI-288-009



Beckman
WI-289-001 - WI-289-006
22.0 cm / 8 3/4"



Beckman
WI-289-007 - WI-289-012
22.0 cm / 8 3/4"



WI-289-001
WI-289-007



WI-289-002
WI-289-008



WI-289-003
WI-289-009



WI-289-004
WI-289-010



WI-289-005
WI-289-011



WI-289-006
WI-289-012



Beckmann
Wf-290-013 - Wf-290-017
22.0 cm / 8 5/8"



Wf-290-013



Wf-290-014



Wf-290-015



Wf-290-016



Wf-290-017



St. Clair-Thomson
Wf-290-018 - Wf-290-021
21.0 cm / 8 1/4"



Wf-290-018



Wf-290-019



Wf-290-020



Wf-290-021

Rhinology Adenotomes, Antrum Retractor

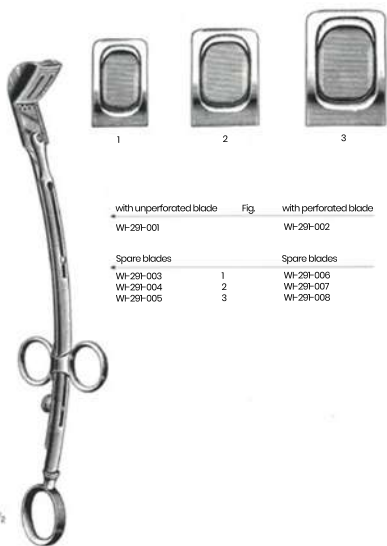

| with unperforated blade | Fig. | with perforated blade |
|-------------------------|------|-----------------------|
| Wf-29f-001 | | Wf-29f-002 |
| Spare blades | | Spare blades |
| Wf-29f-003 | 1 | Wf-29f-006 |
| Wf-29f-004 | 2 | Wf-29f-007 |
| Wf-29f-005 | 3 | Wf-29f-008 |

La Force
Wf-29f-001 - Wf-29f-002 (with one blade)
25.0 cm / 10"

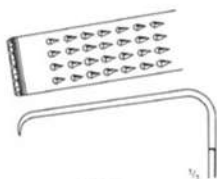

Bruenings-Brunk
Wf-29f-009 (Antrum Retractors)
21.5 cm / 8 1/2"

Cardiovascular Bone and Rib Shears



WI-292-001
23.0 cm / 9"



WI-292-002
22.0 cm / 8 3/4"



WI-292-003
17.0 cm / 6 3/4"



Gluck
WI-292-004
22.0 cm / 8 3/4"

with eccentric
sliding blade



Stille
WI-292-005
21.0 cm / 8 1/4"

**Cardiovascular
Rib Shears, Sternum
Scissors, Sternum Chisel**



Sauerbruch
WI-293-006
28.0cm / 10 1/2"



Giartz-Stille
WI-293-007
27.0cm / 10 1/2"



Sauerbruch
WI-293-008
36.0cm / 14"



Lebsche
WI-293-009
25.0 cm / 10"



WI-293-010
for the right hand

WI-293-011
for the left hand

Bruner
WI-293-010 - WI-293-011
32.0 cm / 12 1/2"



Lebsche
WI-293-012
24.5 cm / 9 3/4"

Cardiovascular Rib Spreaders

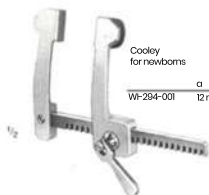
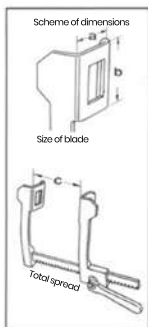

Cooley
for newborns

| | a | b | c |
|------------|-------|-------|-------|
| Wf-294-001 | 12 mm | 17 mm | 75 mm |



Cooley
pediatric size

| | a | b | c |
|------------|-------|-------|--------|
| Wf-294-002 | 16 mm | 30 mm | 105 mm |
| Wf-294-003 | 21 mm | 44 mm | 150 mm |



Cooley
for adults

| | a | b | c |
|------------|-------|-------|--------|
| Wf-294-004 | 37 mm | 49 mm | 200 mm |

Cardiovascular Rib Spreaders

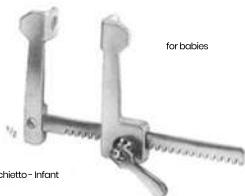
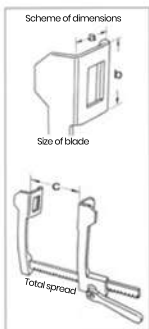

| | a | b | c |
|------------|-------|-------|-------|
| WI-295-005 | 15 mm | 15 mm | 75 mm |



| | a | b | c |
|------------|-------|-------|--------|
| WI-295-006 | 31 mm | 31 mm | 100 mm |



| | a | b | c |
|------------|-------|-------|--------|
| WI-295-007 | 38 mm | 44 mm | 135 mm |
| WI-295-008 | 52 mm | 62 mm | 175 mm |
| WI-295-009 | 85 mm | 65 mm | 175 mm |



Schema of dimensions



Size of blade

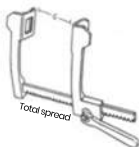

Total spread

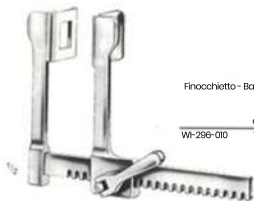

Finocchietto - Baby

| | a | b | c |
|------------|-------|-------|-------|
| Wt-296-010 | 18 mm | 20 mm | 75 mm |



Finocchietto

| | a | b | c | |
|------------|-------|-------|--------|--------|
| Wt-296-011 | 40 mm | 40 mm | 185 mm | Small |
| Wt-296-012 | 45 mm | 65 mm | 200 mm | Medium |
| Wt-296-013 | 70 mm | 65 mm | 250 mm | Large |

Cardiovascular Tissue and Organ Holding Forceps



Lovelace
WI-297-001
20.0 cm / 8"



Lovelace
WI-297-002
20.0 cm / 8"

Cardiovascular Atrauma Cardiovascular Forceps



Dale
WF-298-001
18.5 cm / 7 1/4"

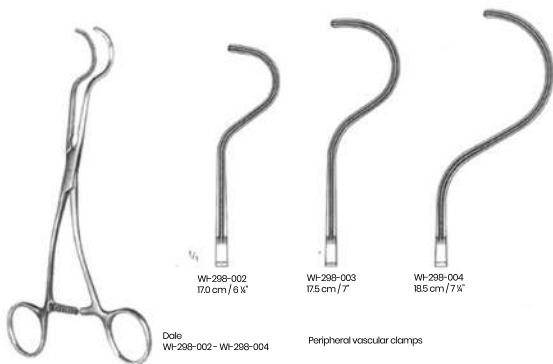

WF-298-002
17.0 cm / 6 3/4"

WF-298-003
17.5 cm / 7"

WF-298-004
18.5 cm / 7 1/4"

Dale
WF-298-002 - WF-298-004

Peripheral vascular clamps

Cardiovascular Atrauma Tissue Forceps



27 mm



De Bakley
 WF-299-001 - 16.0 cm / 6 1/4"
 WF-299-002 - 20.0 cm / 8"
 WF-299-003 - 24.0 cm / 9 1/2"
 WF-299-004 - 30.0 cm / 12"

15 mm



De Bakley
 WF-299-005 - 16.0 cm / 6 1/4"
 WF-299-006 - 20.0 cm / 8"
 WF-299-007 - 24.0 cm / 9 1/2"

20 mm

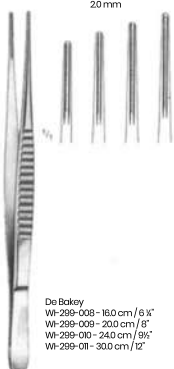

De Bakley
 WF-299-008 - 16.0 cm / 6 1/4"
 WF-299-009 - 20.0 cm / 8"
 WF-299-010 - 24.0 cm / 9 1/2"
 WF-299-011 - 30.0 cm / 12"

20 mm

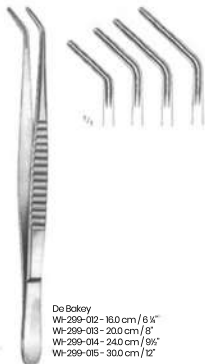

De Bakley
 WF-299-012 - 16.0 cm / 6 1/4"
 WF-299-013 - 20.0 cm / 8"
 WF-299-014 - 24.0 cm / 9 1/2"
 WF-299-015 - 30.0 cm / 12"

35 mm



De Bakley
 WF-299-016 - 16.0 cm / 6 1/4"
 WF-299-017 - 20.0 cm / 8"
 WF-299-018 - 24.0 cm / 9 1/2"
 WF-299-019 - 30.0 cm / 12"

20 mm



Coolley
 WF-299-020 - 16.0 cm / 6 1/4"
 WF-299-021 - 20.0 cm / 8"

Cardiovascular Atrauma Bulldogs Clamps

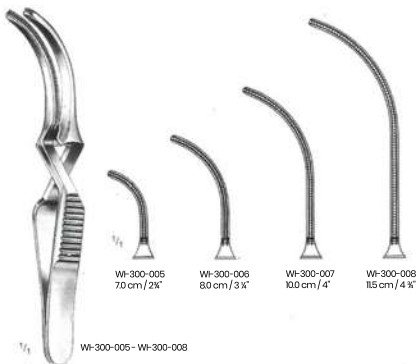
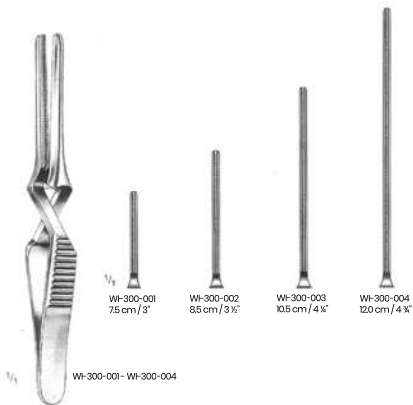

General Instruments Atrauma Cardiovascular Forceps



WI-301-001
21.0 cm 8 1/4"



WI-301-002
22.0 cm 8 1/4"

Potts
WI-301-001-WI-301-002



WI-301-003
21.0 cm 8 1/4"



WI-301-004
21.0 cm 8 1/4"

Potts
WI-301-003-WI-301-004



WI-301-005
21.0 cm 8 1/4"



WI-301-006
22.0 cm 8 1/4"

Potts
WI-301-005-WI-301-006



Coarctation Forceps

Cardiovascular Atrauma Cardiovascular Forceps

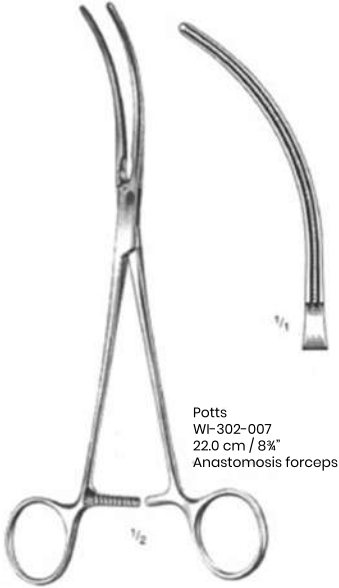

Potts
WI-302-007
22.0 cm / 8 3/4"
Anastomosis forceps



Potts
WI-302-008
22.0 cm / 8 3/4"
Anastomosis forceps



De Bakery
WI-302-009-WI-302-010



WI-302-009
19.0 cm / 7 1/2"



WI-302-010
23.0 cm / 9"

Cardiovascular Atrauma Cardiovascular Forceps



De Bakery
WI-303-011
16.0 cm / 6 1/4"

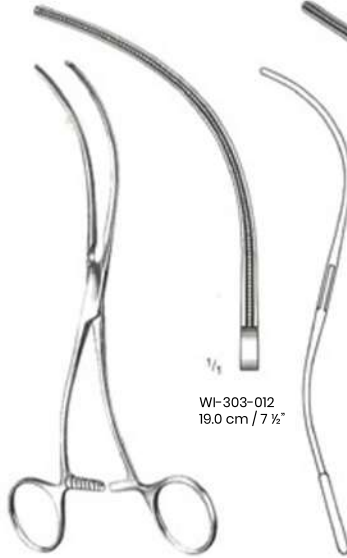

WI-303-012
19.0 cm / 7 1/2"

De Bakery
WI-303-012- WI-303-013

WI-303-013
20.0 cm / 8"

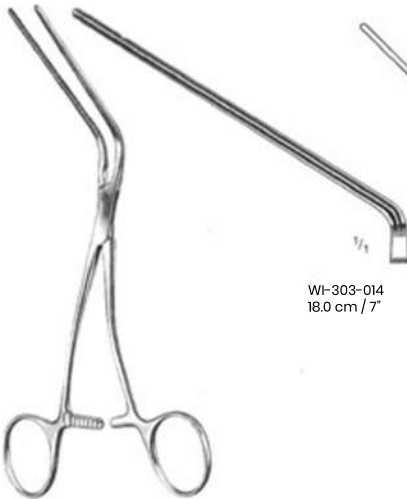

Leland-jones
WI-303-014- WI-303-016

WI-303-014
18.0 cm / 7"

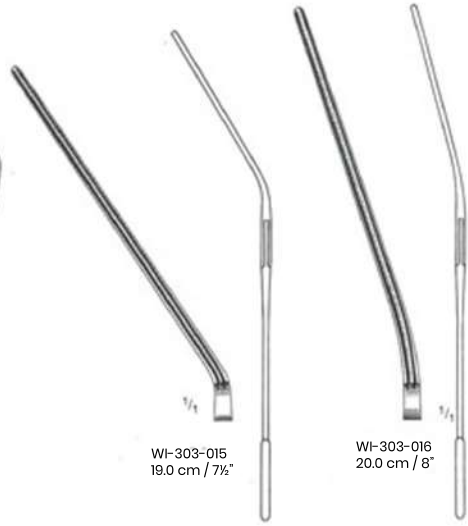

WI-303-015
19.0 cm / 7 1/2"

WI-303-016
20.0 cm / 8"

Peripheral vascular clamps

Cardiovascular Atrauma Cardiovascular Forceps

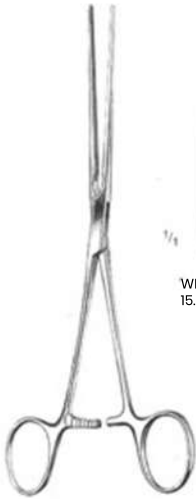

WI-304-017
15.0 cm / 6"

Bainbridge
WI-304-017-WI-304-018



WI-304-018
18.0 cm / 7"



WI-304-019
15.0 cm / 6"

Bainbridge
WI-304-019-WI-304-020



WI-304-020
18.0 cm / 7"



De Bakey
WI-304-021
20.0 cm / 8"



Rental artery clamp

Cardiovascular Atrauma Cardiovascular Forceps



WI-305-022-WI-305-025
Aortic aneurysm clamps



WI-305-022
26.0 cm / 10 1/4"



WI-305-023
27.0 cm / 10 1/2"



WI-305-024
31.0 cm / 12 1/4"



WI-305-025
33.0 cm / 13"



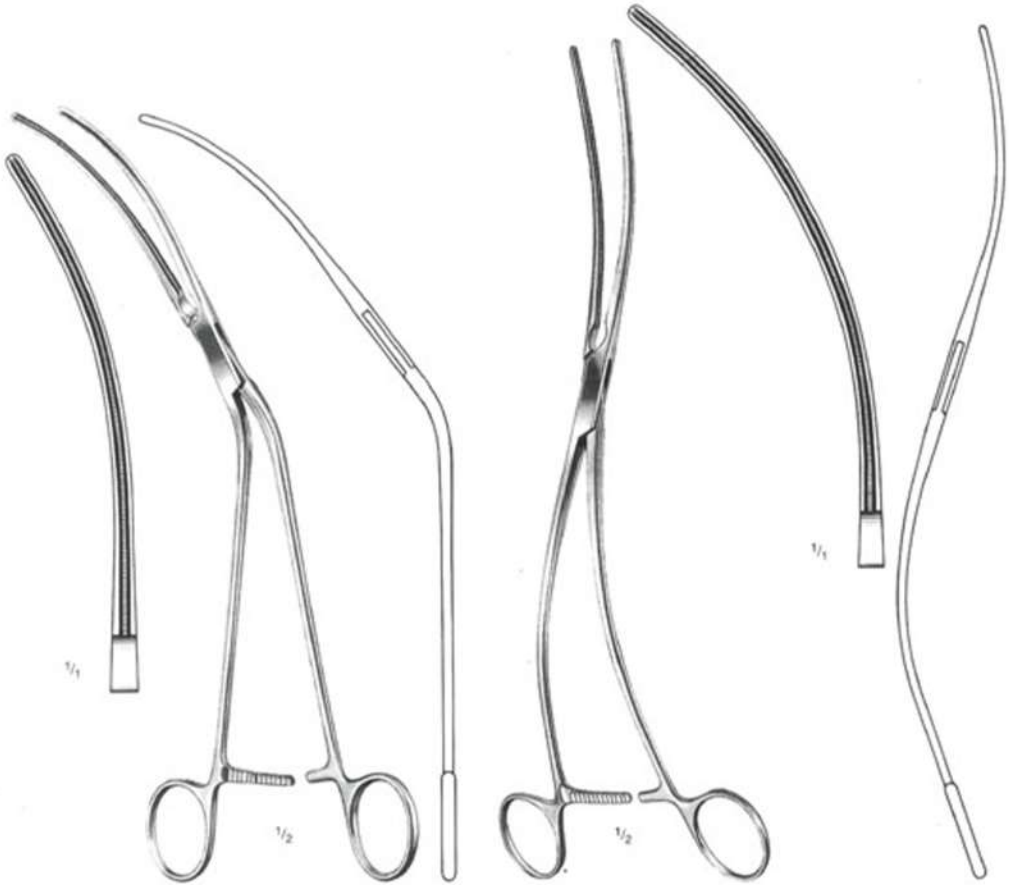

De Bakey
WI-306-001
28.0 cm / 11"

De Bakey
WI-306-002
30.0 cm / 11 3/4"

Artic aneurysm clamps



Top view

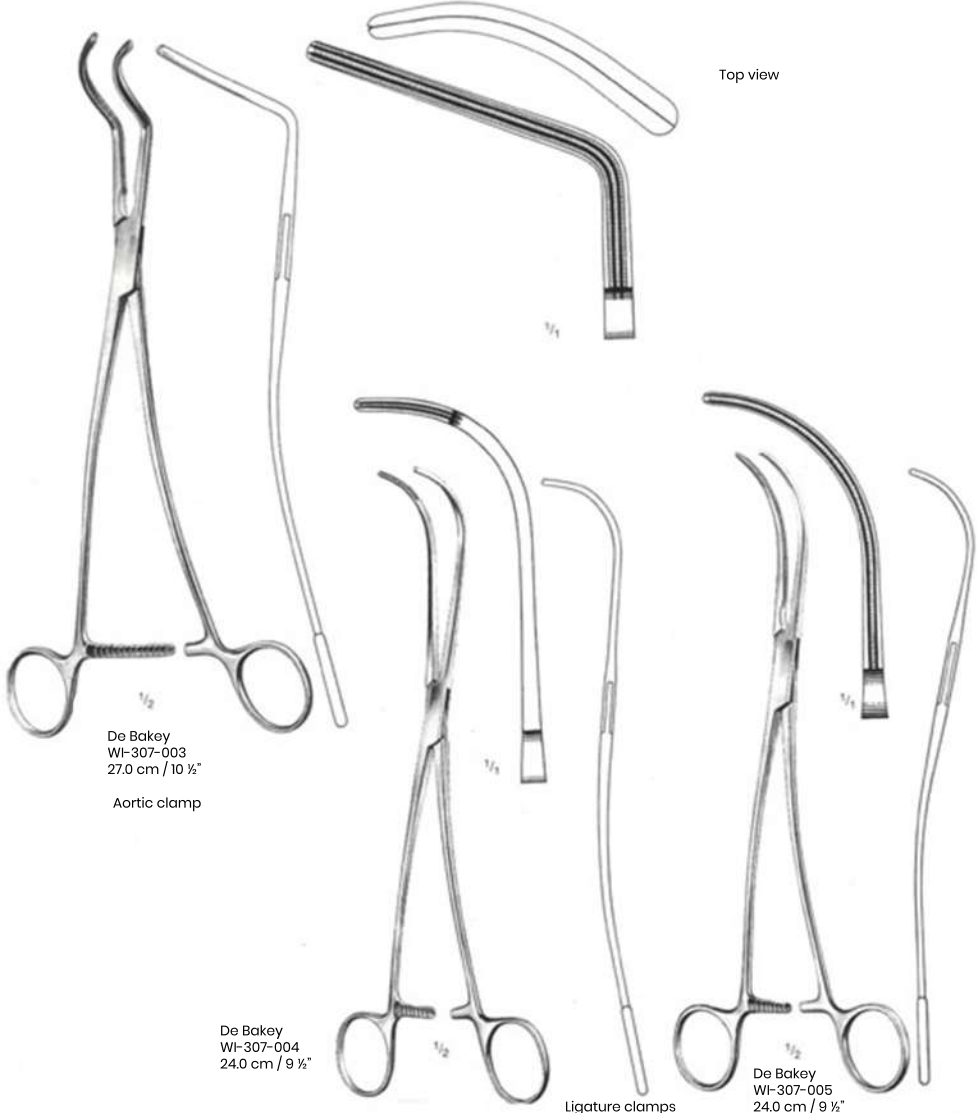

De Bakley
WI-307-003
27.0 cm / 10 1/2"
Aortic clamp

De Bakley
WI-307-004
24.0 cm / 9 1/2"

De Bakley
WI-307-005
24.0 cm / 9 1/2"

Ligature clamps



De Bakay
WI308-006
26.0 cm . 10 1/4"

Aortic clamp

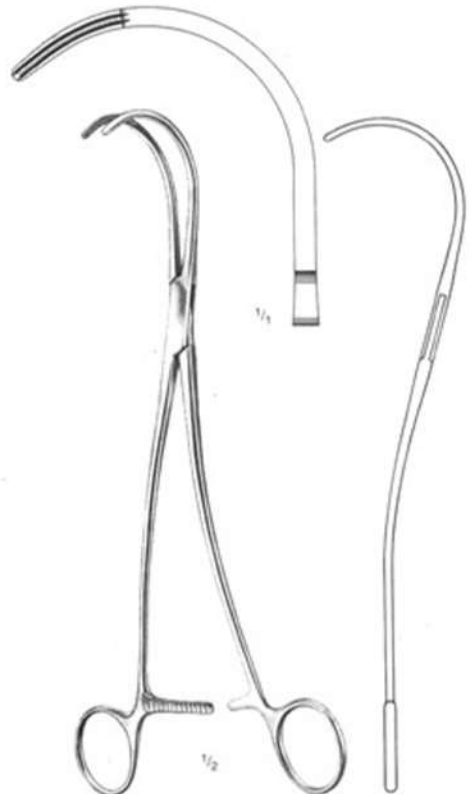

De Bakay
WI308-007
25.0 cm . 10"

Ligature Forceps

Cardiovascular Atrauma Cardiovascular Forceps

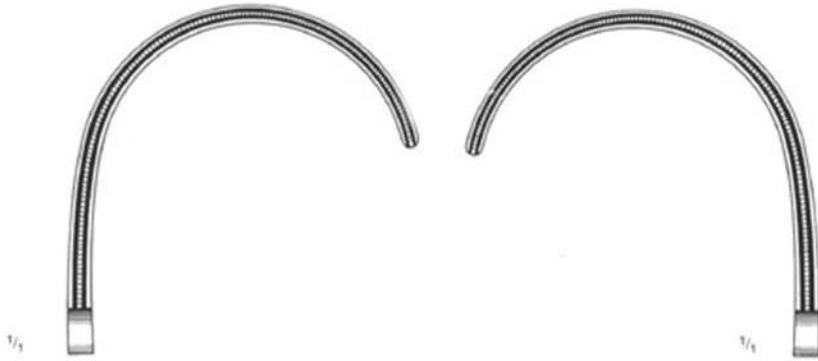

Weber
WI-309-008
26.0 cm / 10 1/4"

left



Weber
WI-309-009
26.0 cm / 10 1/4"

right

Aortic clamps

Cardiovascular Atrauma Cardiovascular Forceps

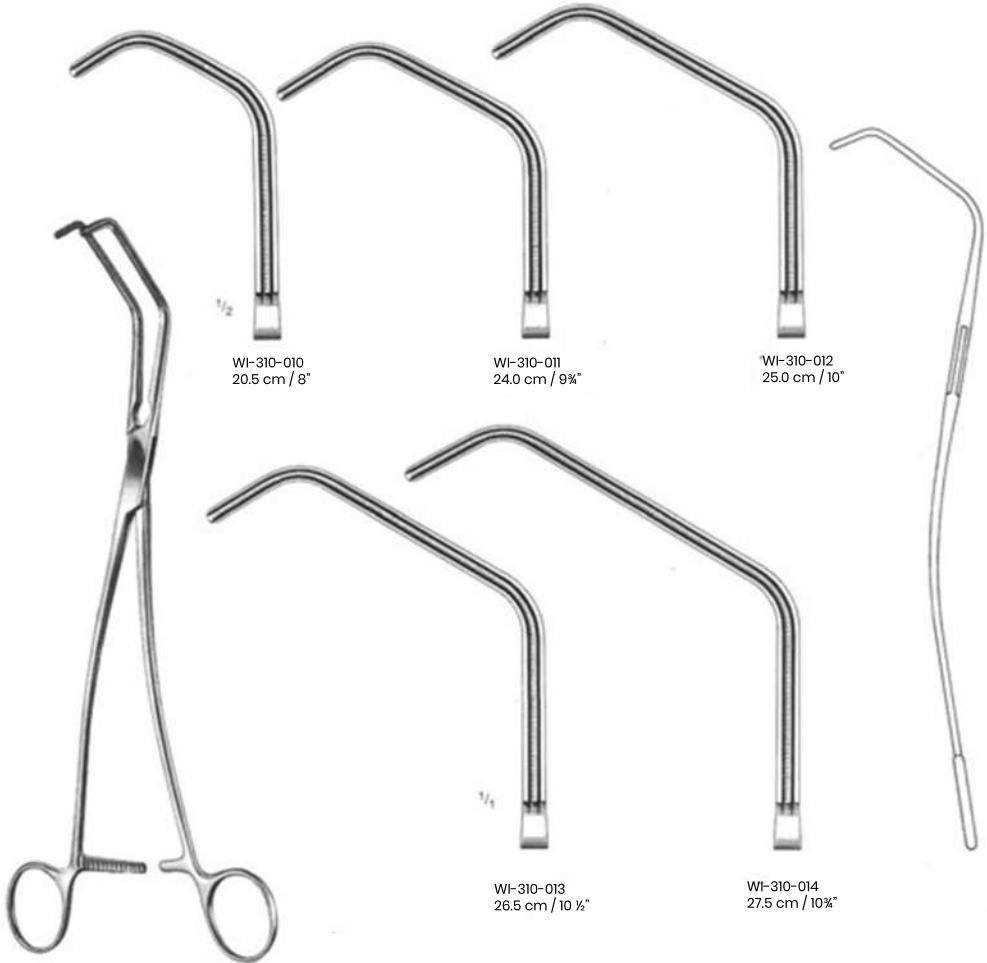

WI-310-010
20.5 cm / 8"

WI-310-011
24.0 cm / 9 1/2"

WI-310-012
25.0 cm / 10"

WI-310-013
26.5 cm / 10 1/2"

WI-310-014
27.5 cm / 10 3/4"

Satinsky
WI-310-010-WI-310-014

Tangential occlusion clamps

Cardiovascular Atrauma Cardiovascular Forceps



Harken
WI-311-015 - WI-311-018



WI-311-015
24.0 cm / 9 1/2"
Auricle clamps



WI-311-016
24.0 cm / 9 1/2"



WI-311-017
24.0 cm / 9 1/2"



WI-311-018
24.0 cm / 9 1/2"

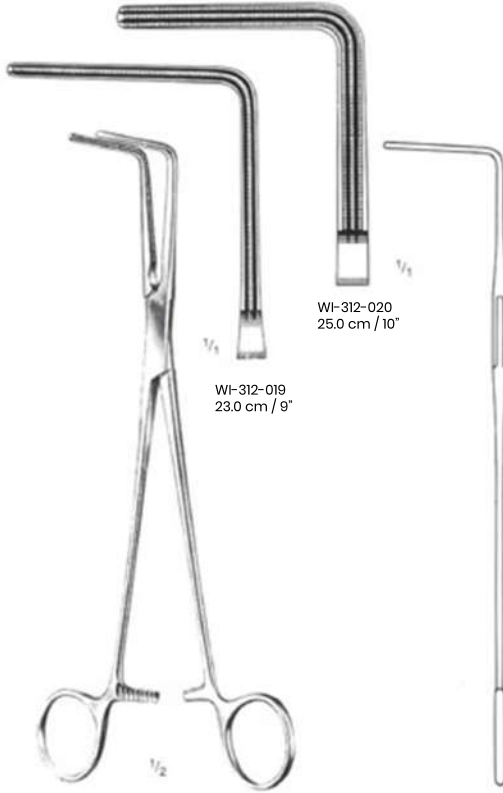

WI-312-019
23.0 cm / 9"
1/4

WI-312-020
25.0 cm / 10"
1/4

Lees
WI-312-019- WI-312-020

Bronchus clamps

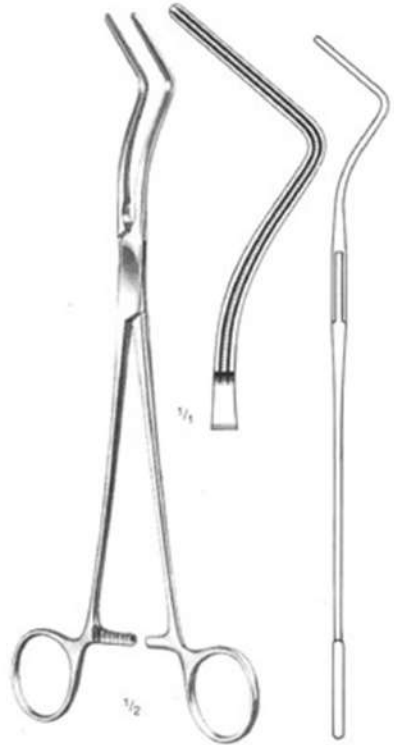

Lees
WI-312-021
25.0 cm / 10"
1/4

Cardiovascular Atrauma Cardiovascular Forceps



Lambert-Kay
WI-313-022-WI-313-023



WI-313-022



WI-313-023

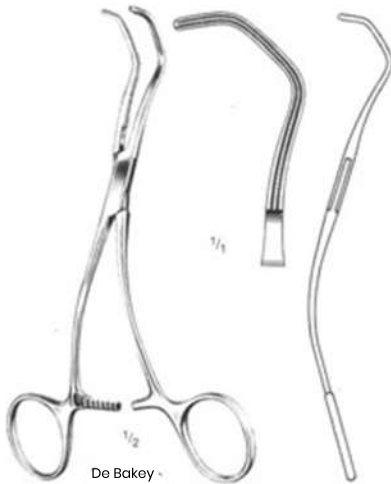

De Bakay -
WI-313-024
17.0 cm 6 3/4"

Cardiovascular Atrauma Cardiovascular Forceps



WI-314-001
18.0 cm / 7"

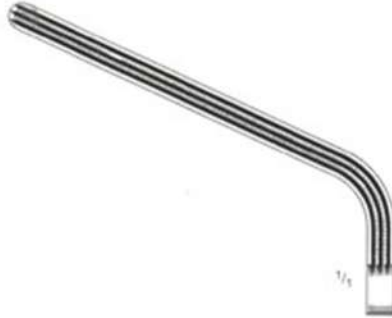

WI-314-002
20.0 cm / 8"



Morris-De Bakey
WI-314-001-WI-314-004

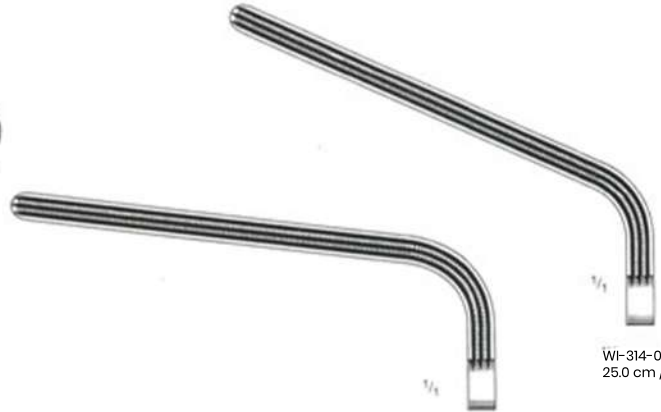

WI-314-003
23.0 cm / 9"

WI-314-004
25.0 cm / 10"

Aortic clamps

Cardiovascular Atrauma Cardiovascular Forceps



De Bakey-Bahnsen
WI-315-005-WI-315-007



WI-315-005[®]
23.0 cm / 9"



WI-315-006
24.0 cm / 9½"



WI-315-007
25.0 cm / 10"

Cardiovascular Atrauma Cardiovascular Forceps



WI-316-008-WI-316-011



WI-316-008
21.5 cm / 8½"



WI-316-009
23.0 cm / 9"



WI-316-010
27.0 cm / 10½"



WI-316-011
31.5 cm / 12½"



WI-316-012-WI-316-015



WI-316-012
21.5 cm / 8½"



WI-316-013
23.0 cm / 9"



WI-316-014
27.0 cm / 10½"



WI-316-015
31.5 cm / 12½"

COARCTATION CLAMPS

Cardiovascular Atrauma Cardiovascular Forceps



De Bakky
WI-317-016-WI-317-019

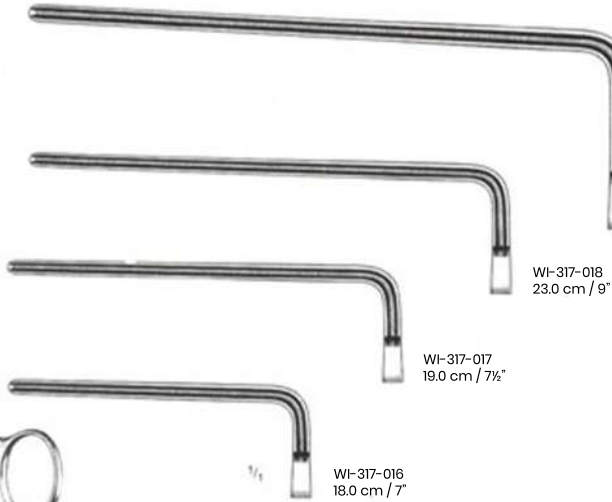

WI-317-016
18.0 cm / 7"

WI-317-017
19.0 cm / 7½"

WI-317-018
23.0 cm / 9"

WI-317-019
27.0 cm / 10½"

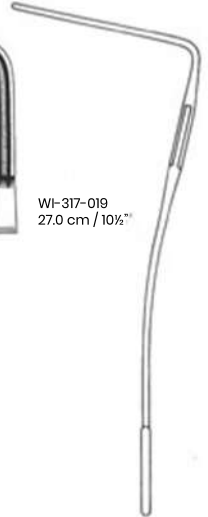

Multi purpose clamps

WI-317-020-WI-317-023

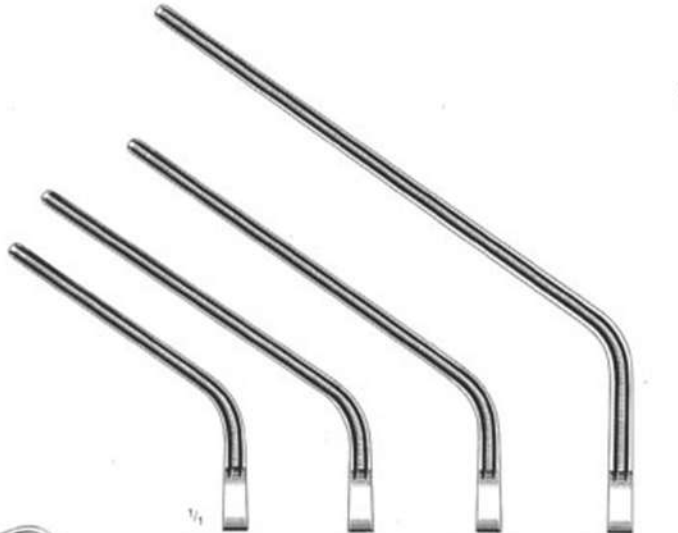

WI-317-020
20.0 cm / 8"

WI-317-021
21.0 cm / 8¼"

WI-317-022
25.0 cm / 10"

WI-317-023
29.0 cm / 11¼"



Cardiovascular Atrauma Cardiovascular Forceps



De Bakey-Pean
WI-318-001-WI-318-005



De Bakey-Mosquito
WI-318-001
12.0 cm / 4 3/4"



WI-318-002
14.0 cm / 5 1/2"



WI-318-003
16.0 cm / 6 1/4"



WI-318-004
18.0 cm / 7"



WI-318-005
20.0 cm / 8"



De Bakey-Pean
WI-318-006-WI-318-010



De Bakey-Mosquito
WI-318-006
12.0 cm / 4 3/4"



WI-318-007
14.0 cm / 5 1/2"



WI-318-008
16.0 cm / 6 1/4"



WI-318-009
18.0 cm / 7"



WI-318-010
20.0 cm / 8"

Cardiovascular Atrauma Cardiovascular Forceps



De Bakey
WI-319-001
17.0 cm / 6¾"

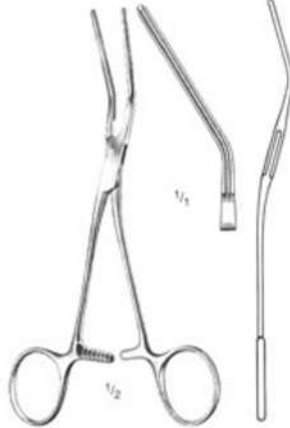

De Bakey
WI-319-002
16.0 cm / 6¼"



De Bakey
WI-319-003
15.0 cm / 6"



De Bakey
WI-319-004
15.0 cm / 6"



De Bakey
WI-319-005
17.0 cm / 6¾"

Cardiovascular Atrauma Cardiovascular Forceps



Glover
WI-320-006
17.0 cm / 6 3/4"



WI-320-007
17.0 cm / 6 3/4"

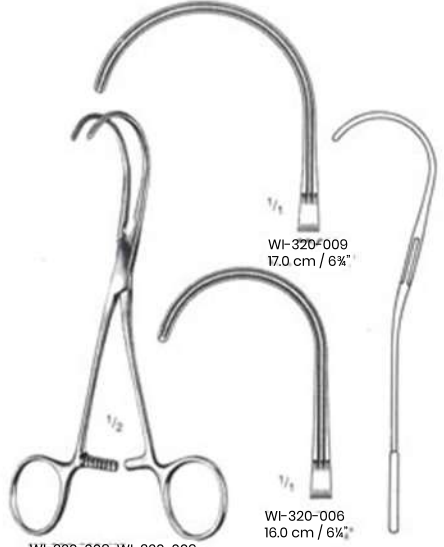

WI-320-008-WI-320-009

WI-320-009
17.0 cm / 6 3/4"

WI-320-006
16.0 cm / 6 1/4"

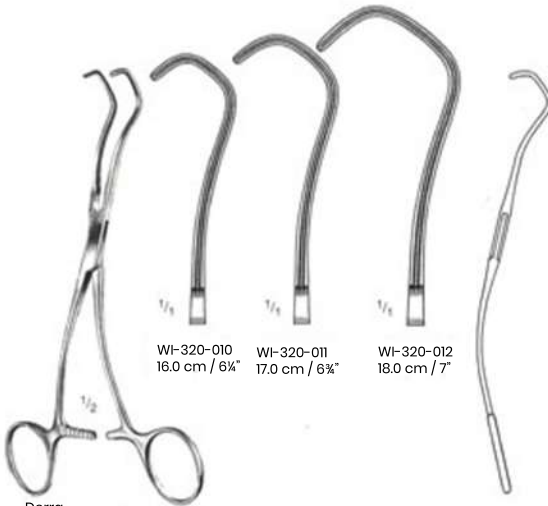

Derra
WI-320-010-WI-320-012

WI-320-010
16.0 cm / 6 1/4"

WI-320-011
17.0 cm / 6 3/4"

WI-320-012
18.0 cm / 7"



Beck
WI-320-013
17.0 cm / 6 3/4"

Cardiovascular Atrauma Cardiovascular Forceps



De Bakey
WI-321-014
10.0 cm / 4"



De Bakey
WI-321-015
11.0 cm / 4 1/4"



De Bakey
WI-321-016
12.0 cm / 4 3/4"



De Bakey
WI-321-017
12.0 cm / 4 3/4"

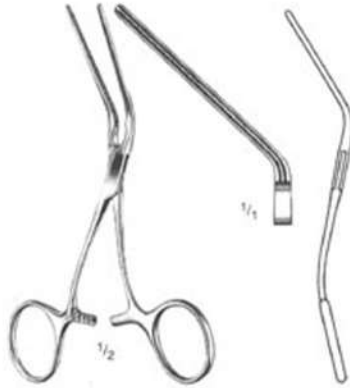

De Bakey
WI-321-018
13.0 cm / 5 1/4"

Cardiovascular
Neonatal and Pediatric
Clamps, Very Delicate
Patterns



Cooley
WI-322-001-WI-322-002
14.0 cm / 5 1/2"



WI-322-001
14.0 cm / 5 1/2"



WI-322-002
14.0 cm / 5 1/2"



Cooley
WI-322-003
14.0 cm / 5 1/2"



Cooley
WI-322-004
14.0 cm / 5 1/2"



Cooley
WI-322-005
14.0 cm / 5 1/2"



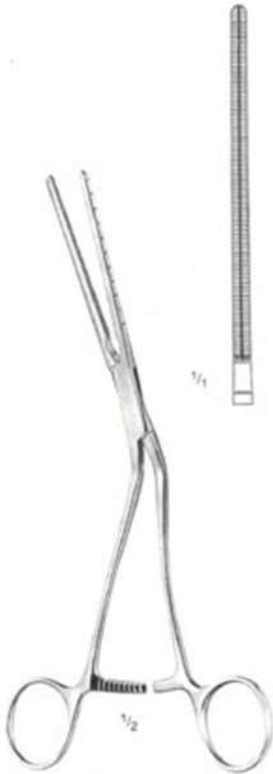

Cooley
WI-323-001
21.0 cm / 8 1/4"

iliac clamp



Cooley
WI-323-002
17.0 cm / 6 3/4"

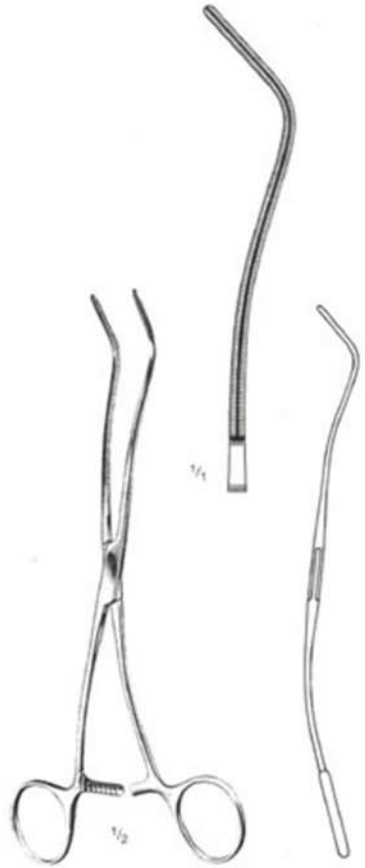

Cooley
WI-323-003
20.0 cm / 8"

Cardiovascular Atrauma Cardiovascular Forceps

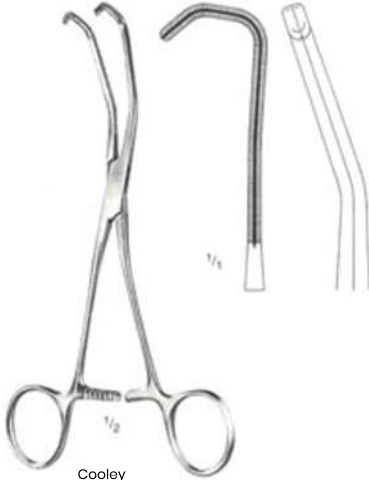

Cooley
WI-324-004
17.0 cm / 6 3/4"

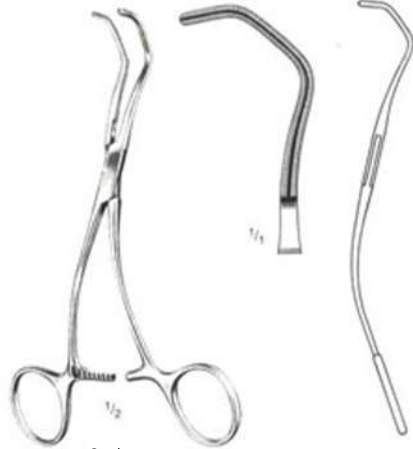

Cooley
WI-324-005
16.0 cm / 6 1/4"



Cooley
WI-324-006
15.0 cm / 6"

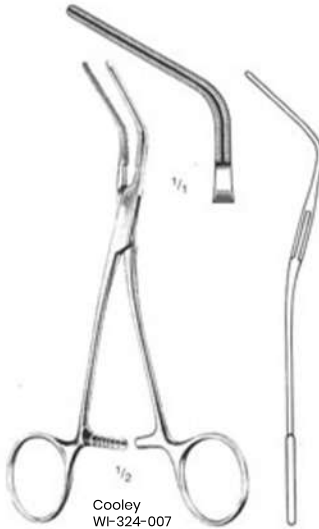

Cooley
WI-324-007
15.5 cm / 6 1/8"



Cooley
WI-324-008
17.0 cm / 6 3/4"

Cardiovascular Atrauma Cardiovascular Forceps



Cooley
WI-325-009
17.0 cm / 6 3/4"



Cooley
WI-325-010
17.0 cm / 6 3/4"



Cooley
WI-325-011
17.0 cm / 6 1/4"
Coarctatin Clamps

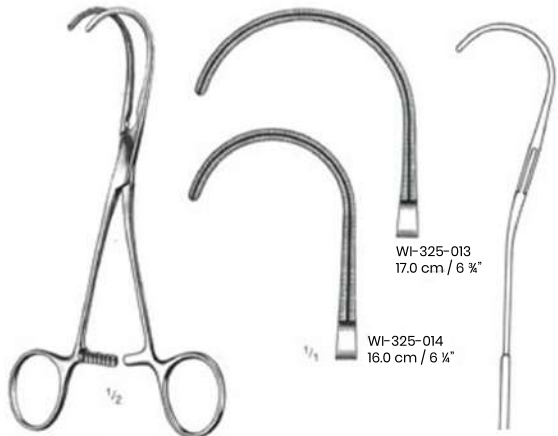

Cooley
WI-325-012-WI-325-013
Ligature Clamps

WI-325-013
17.0 cm / 6 3/4"

WI-325-014
16.0 cm / 6 1/4"

Cardiovascular Instruments For Cranial Opening

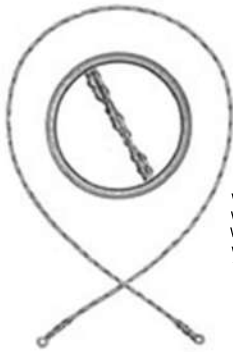

Olivecrona
WI-326-001-WI-326-005

WI-326-001- 30.0 cm / 12"
WI-326-002- 40.0 cm / 16"
WI-326-003- 50.0 cm / 20"
WI-326-004- 60.0 cm / 24"
WI-326-005 - 70.0 cm / 28"



WI-326-006



Martel
WI-326-007
33.0 CM / 13"

Intestines Stomach Rectum Tissue and Organ Holding Forceps



Allis-Baby
WI-327-001
12.0 cm / 4 3/4"
4 x 5 teeth



WI-327-002
15.0 cm / 6"

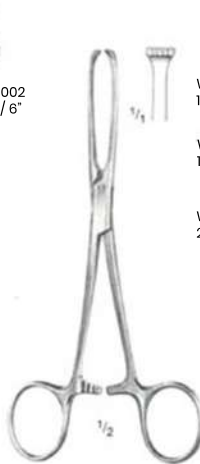

WI-327-003
15.0 cm / 6"

WI-327-004
19.0 cm / 7 1/2"

WI-327-005
25.0 cm / 10"

Allis-Tissue
WI-327-002-WI-327-005

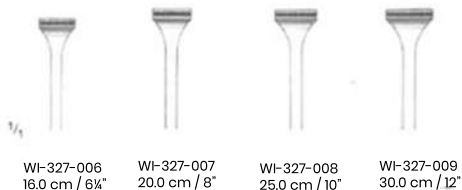
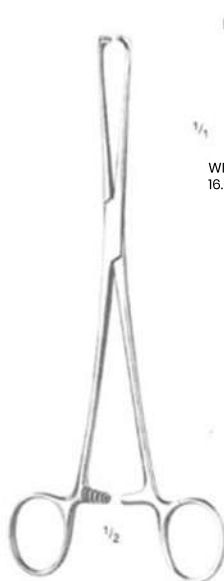

WI-327-006
16.0 cm / 6 1/4"

WI-327-007
20.0 cm / 8"

WI-327-008
25.0 cm / 10"

WI-327-009
30.0 cm / 12"

Allis-Atrauma
WI-327-006-WI-327-009

Intestines Stomach Rectum Tissue and Organ Holding Forceps



Allis-Adair
WI-328-010
15.0 cm / 6"
10 x 11 teeth



Boys-Allis
WI-328-011
15.0 cm / 6"

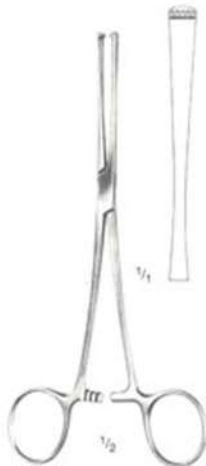

Lockwood-Allis
WI-328-012- 16.0 cm / 6 1/4"
WI-328-013-20.0 cm / 8"



Judid-Allis
WI-328-014- 15.0 cm / 6"
WI-328-015-19.0 cm / 6 1/2"



Thomas-Allis
WI-328-016
20.0 cm / 8"

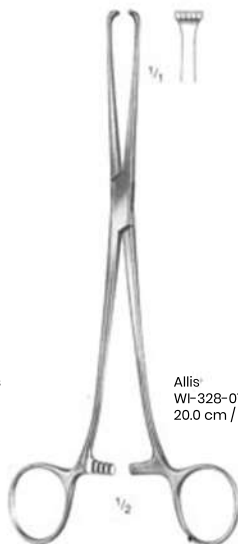

Allis
WI-328-017
20.0 cm / 8"

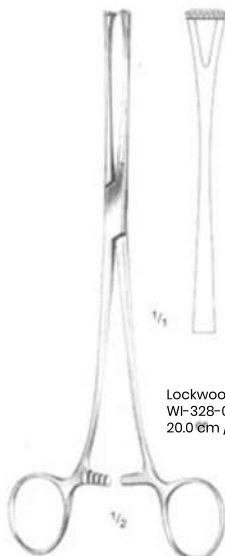

Lockwood
WI-328-018
20.0 cm / 8"

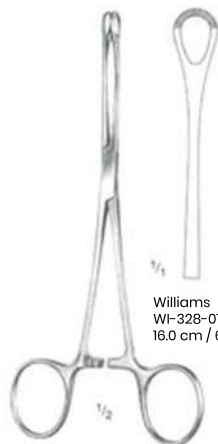

Williams
WI-328-019
16.0 cm / 6 1/4"

Intestines Stomach Rectum Tissue and Organ Holding Forceps



Babcock
WI-329-020-WI-329-023



WI-329-020
16.0 cm / 6 $\frac{1}{4}$ "



WI-329-021
18.0 cm / 7"



WI-329-022
20.0 cm / 8"



WI-329-023
24.0 cm / 9 $\frac{1}{2}$ "

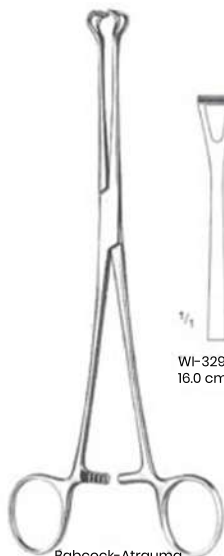

WI-329-024
16.0 cm / 6 $\frac{1}{4}$ "



WI-329-025
20.0 cm / 8"

Babcock-Atrauma
WI-329-024-WI-329-025



WI-329-026
18.0 cm / 7"

WI-329-027
20.0 cm / 8"



WI-329-028
20.0 cm / 7"

WI-329-029
23.0 cm / 9"

Duval
WI-329-026-WI-329-029

Intestines Stomach Rectum Intestinal Clamps Forceps



Brunner
WI-330-01
24.0 cm / 9 1/2"



WI-330-002
21.0 cm / 8 1/4"

WI-330-003
23.0 cm / 9"



WI-330-004
21.0 cm / 8 1/4"

WI-330-005
23.0 cm / 9"

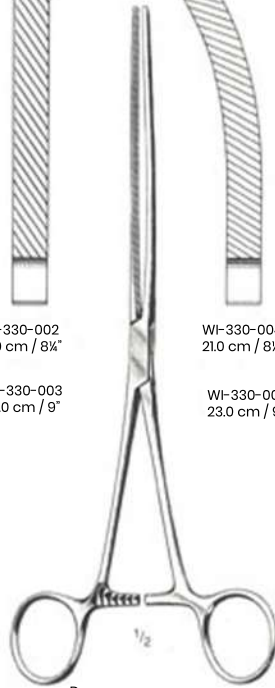

Dyen
WI-330-002-WI-330-005



WI-330-006
18.0 cm / 7"



WI-330-007
18.0 cm / 7"



Dyen-baby
WI-330-006-WI-330-007
18.0 cm / 7"

Intestines Stomach Rectum Intestinal Clamps Forceps

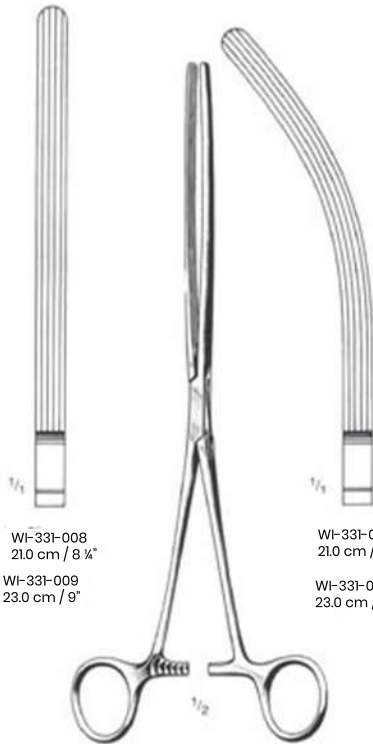

WI-331-008
21.0 cm / 8 1/4"

WI-331-009
23.0 cm / 9"

Mayo-Robson
WI-331-008-WI-331-011



WI-331-010
21.0 cm / 8 1/4"

WI-331-011
23.0 cm / 9"

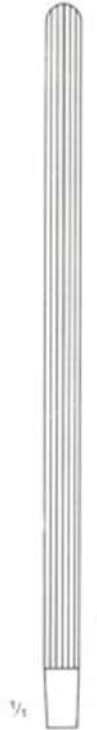

WI-331-012

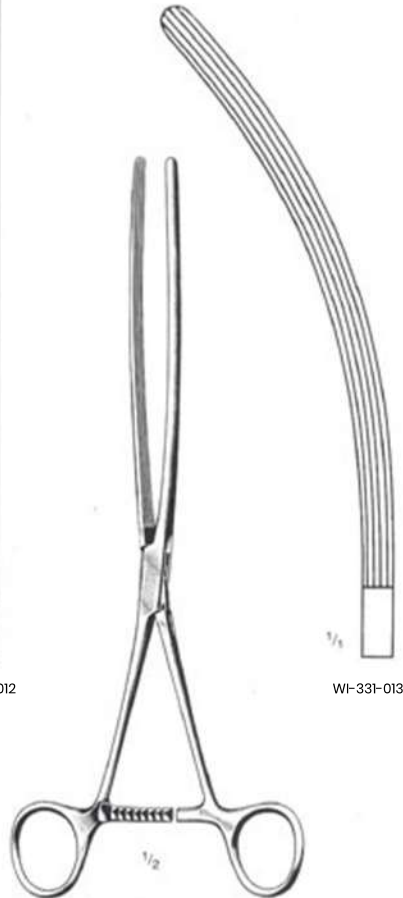

WI-331-013

Mayo-Robson
WI-331-012-WI-331-013
25.0 cm / 10"

Intestines Stomach Rectum Intestinal Clamps Forceps

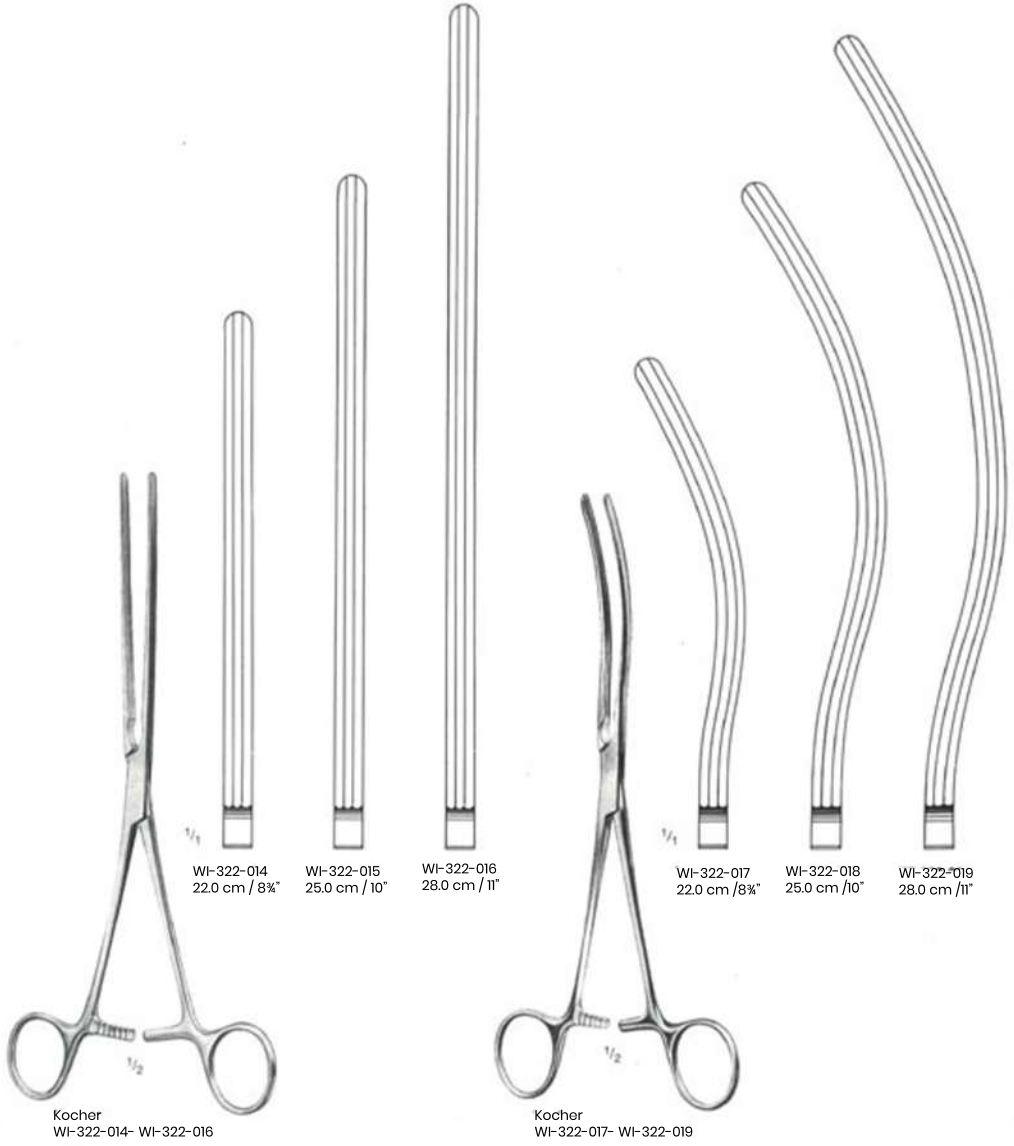

WI-322-014
22.0 cm / 8 3/4"

WI-322-015
25.0 cm / 10"

WI-322-016
28.0 cm / 11"

WI-322-017
22.0 cm / 8 3/4"

WI-322-018
25.0 cm / 10"

WI-322-019
28.0 cm / 11"

Kocher
WI-322-014- WI-322-016

Kocher
WI-322-017- WI-322-019

*Intestines Stomach Rectum
Intestinal Clamps Forceps*

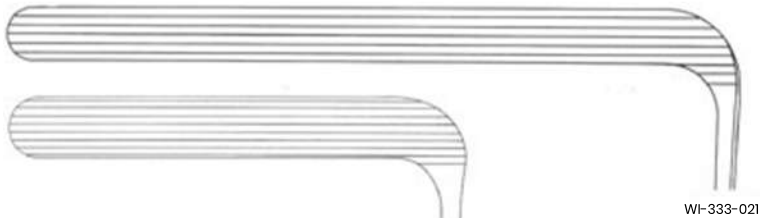

WI-333-021



WI-333-020



Mikulicz
WI-333-020-WI-333-021
19.0 cm / 7 1/2"

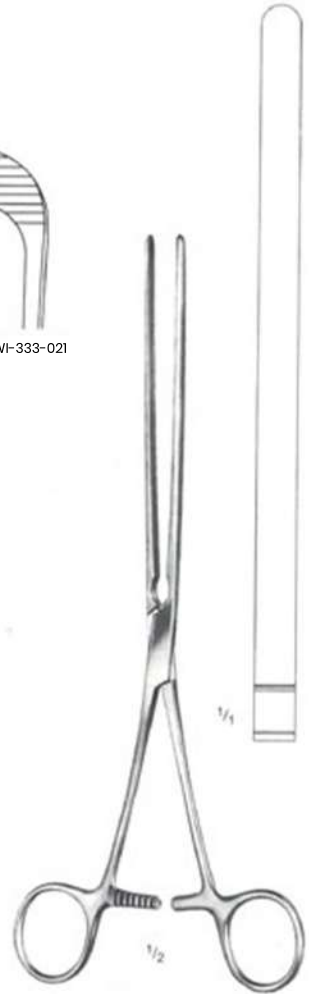

Scudder
WI-333-022
25.0 cm / 10"

Intestines Stomach Rectum Intestinal and Stomach Clamps (Crushing Clamps)

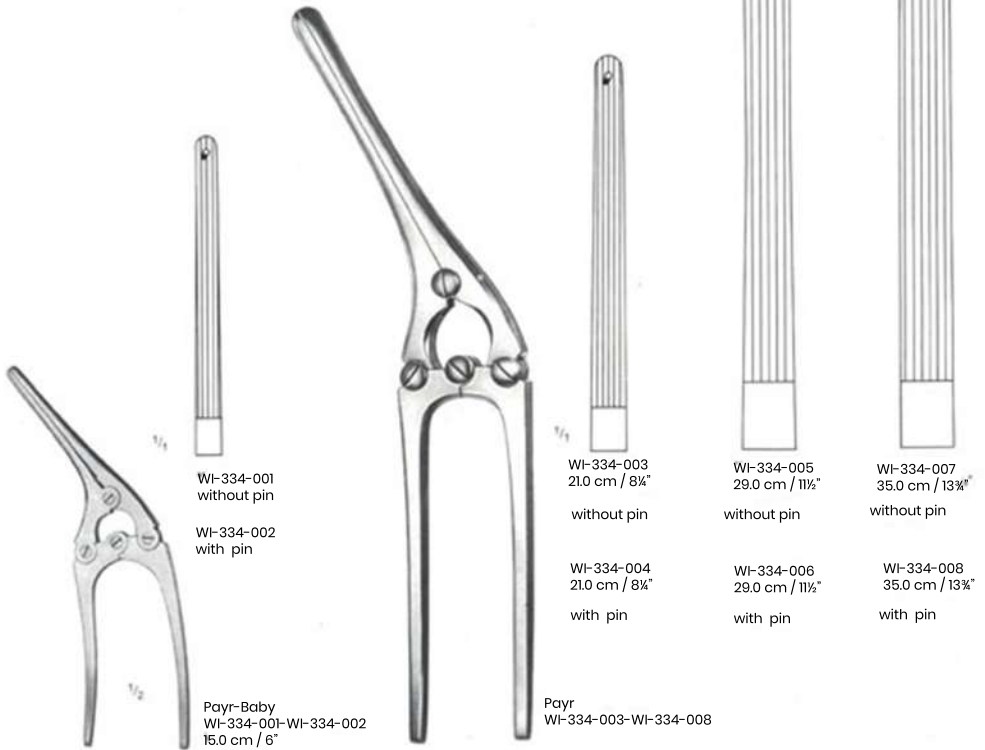

Intestines Stomach Rectum Antrauma Intestinal and Stomach Clamps Forceps



Doyen- Atrauma
WI-335-001-WI-335-004

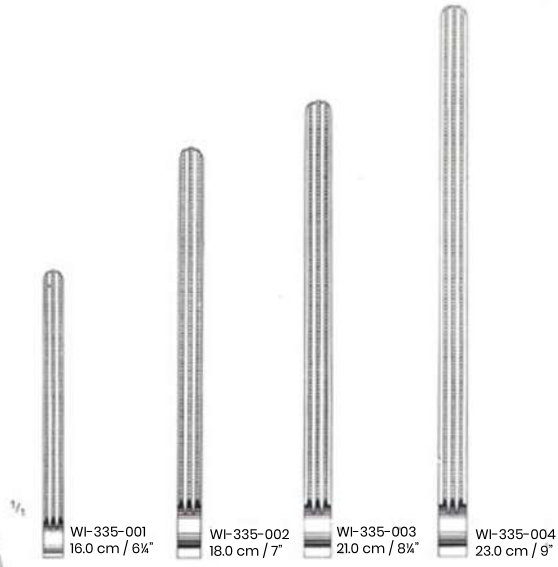

Doyen- Atrauma
WI-335-005-WI-335-008

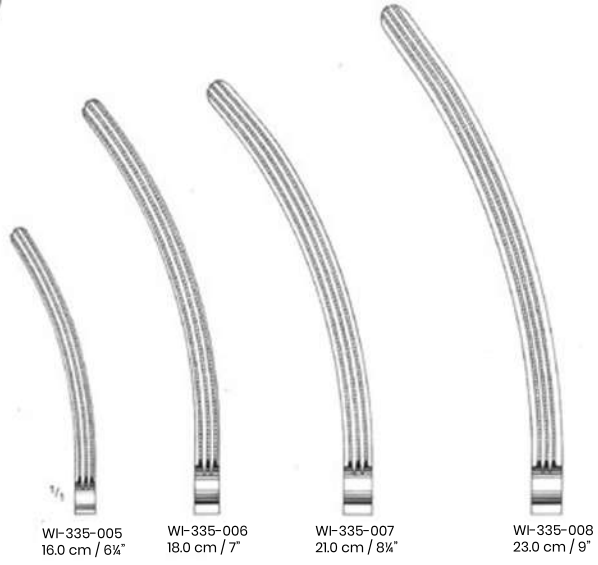

Intestines Stomach Rectum Rectal Spacula

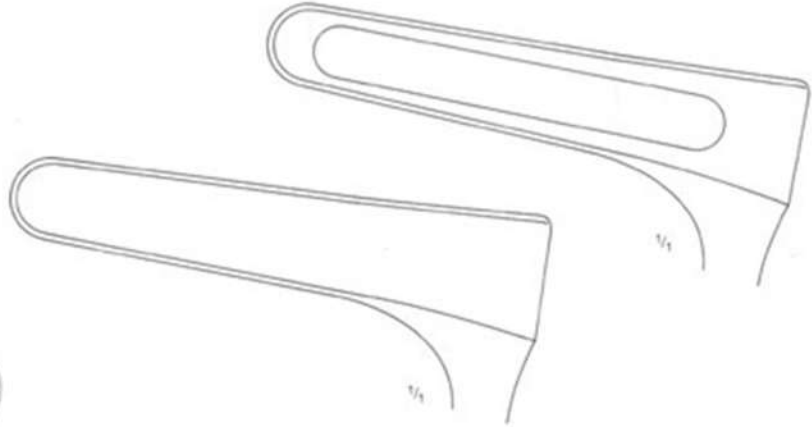

Czerny
WI-336-001
22.0 cm / 8 1/2"



Sims
WI-336-002
15.0 cm / 6"



Sims
WI-336-003
15.0 cm / 6"



Sims
WI-336-004
15.0 cm / 6"

*with interchangeable fiber optic light carrier

**Intestines Stomach Rectum
Rectal Specula, Anal Retractors,
Anoscope Proctoscope**



Ives-Fanster
WI-337-001
22 mm Ø



Ives-Fanster
WI-337-002
22 mm Ø



Hirschmann
WI-337-003-16 mm Ø x 65 mm
WI-337-004-16 mm Ø x 65 mm
WI-337-005-22 mm Ø x 65 mm



Kelly
WI-337-006-21 mm Ø x 50 mm
WI-337-007-27 mm Ø x 50 mm



Kelly
WI-337-008-22 mm Ø x 50 mm
WI-337-009-22 mm Ø x 100 mm
WI-337-010-22 mm Ø x 140 mm



Newman
WI-337-011-16 mm Ø x 63 mm
WI-337-012-19 mm Ø x 63 mm
WI-337-013-23 mm Ø x 63 mm

Intestines Stomach Rectum Rectal Biopsy Specimen Forceps

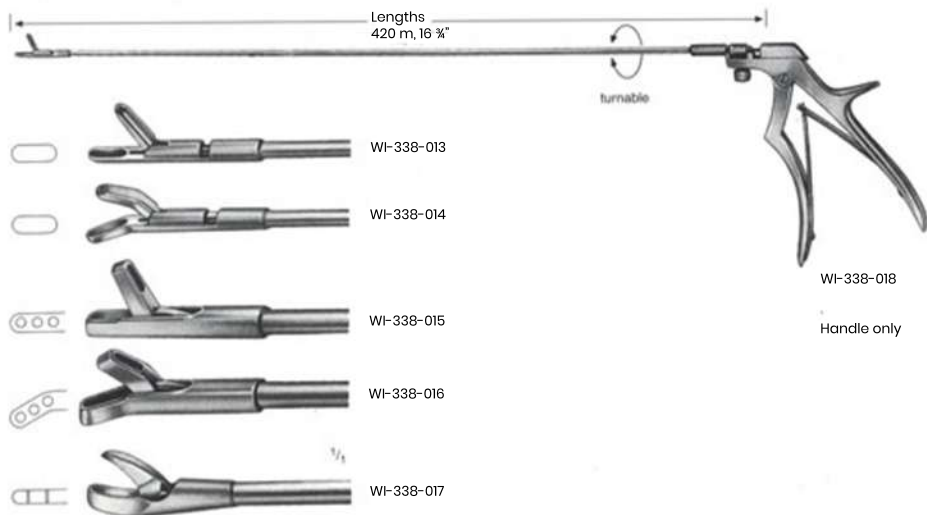
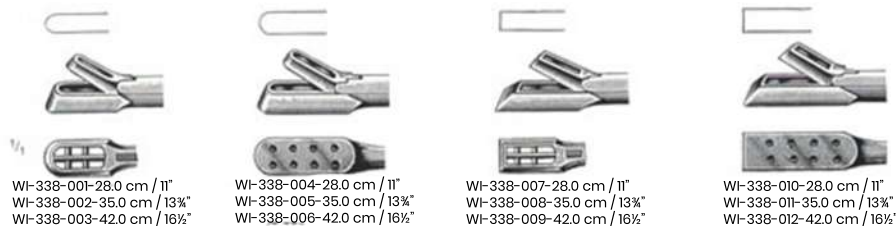
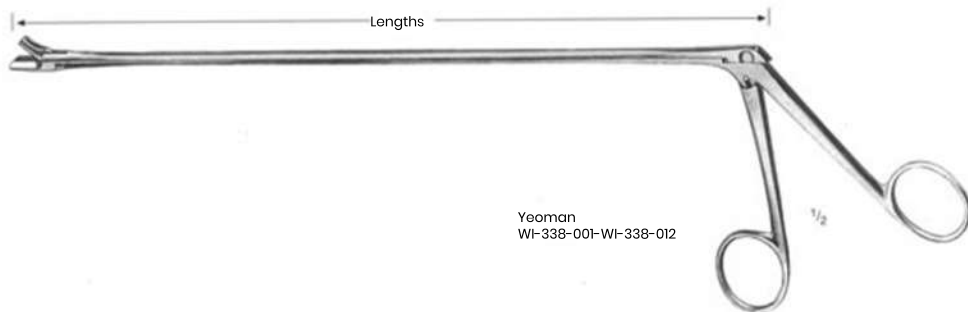

Intestines Stomach Rectal Biopsy Specimen Forceps, Haemorrhoidal (Pile) Forceps

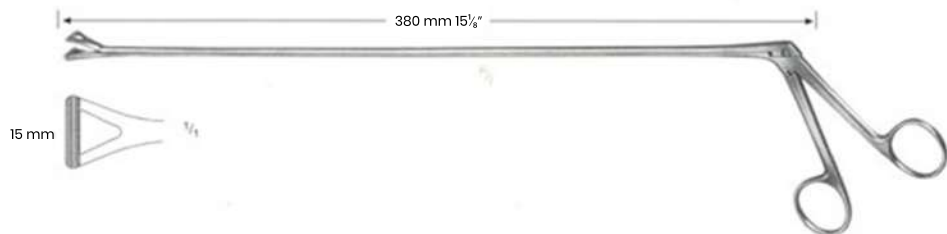

WI-339-001

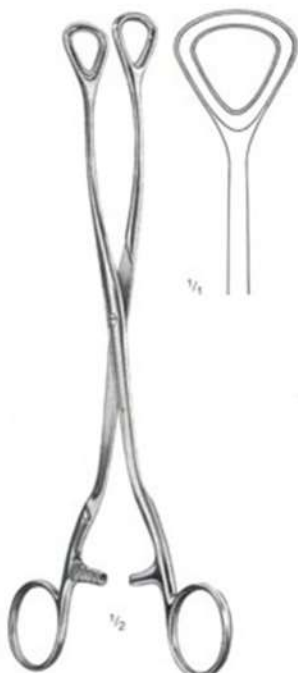

Lucer
WI-339-002
24.5 cm / 9 3/4"

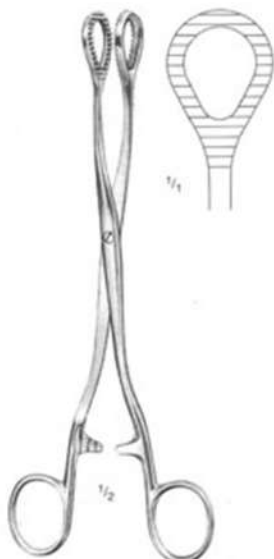

Heywood-Smith
WI-339-003
20.0 cm / 8"



Heywood-Smith
WI-339-004
21.0 cm / 8 1/4"

Liver, Gall, Bladder, Kidney Kidney Stone Forceps

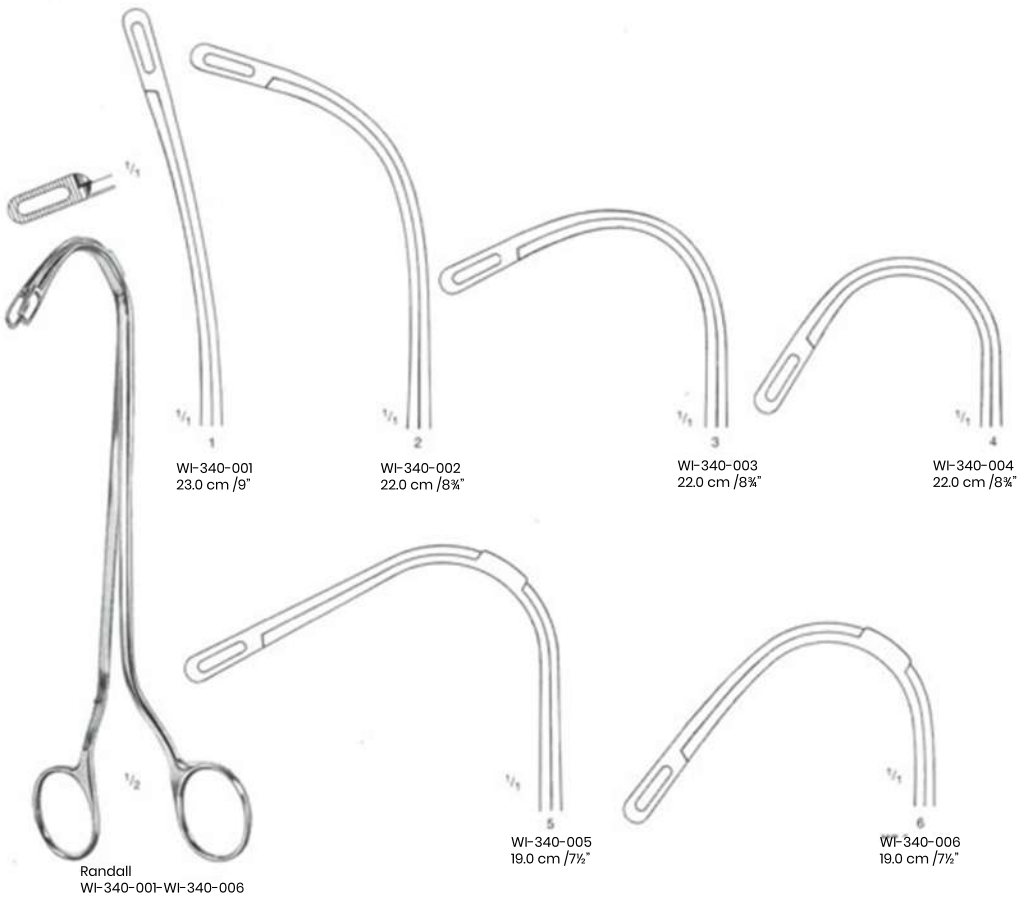
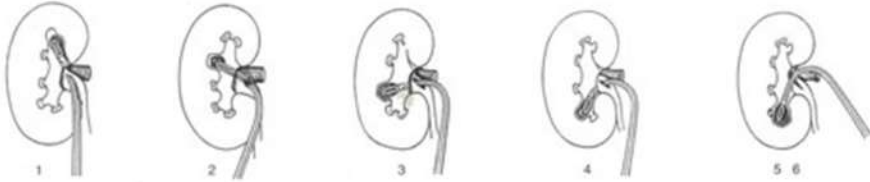

Liver, Gall, Bladder, Kidney Gall Stone Probes, Gall Duct Dilators

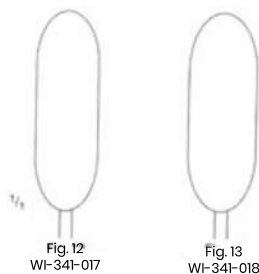
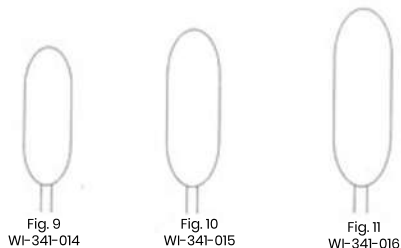
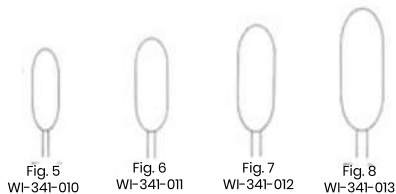
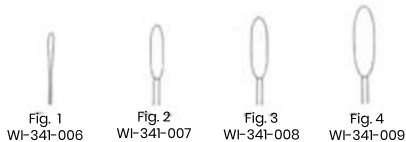

Ochsner
WI-341-001
38.0 cm / 15"



Moynihan
WI-341-002
34.0 cm / 13½"
malleable



Desjardins
WI-341-003-WI-341-005
28.0 cm / 11"
elastic



Bakes
WI-341-006-WI-341-018
30.0 cm / 12"
malleable shaft

Liver, Gall, Bladder, Kidney Gall Stones Forceps, Catchers and Scoops



Mayo-Blake
WI-342-001
20.0 cm / 8"



Mayo-Blake
WI-342-002
20.0 cm / 8"

WI-342-008
26.5 cm / 10 1/2"
maleable

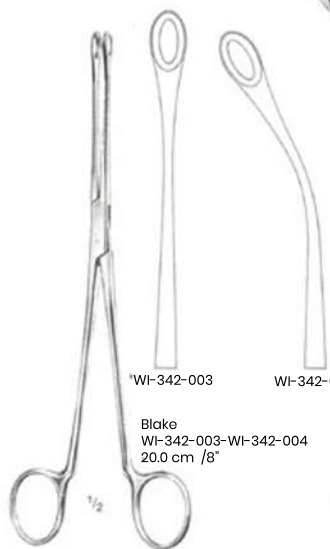

WI-342-003
WI-342-004
Blake
WI-342-003-WI-342-004
20.0 cm / 8"



Mixer
WI-342-005
22.0 cm / 8 3/4"



WI-342-006

WI-342-007

Desjardins
WI-342-006-WI-342-007
23.0 cm / 9"

Liver, Gall, Bladder, Kidney Gall Stone Scoops



WI-343-001

WI-343-002

WI-343-003

WI-343-004

Desjardins
WI-343-001-WI-343-004
30.0 cm / 12"



Luer-Koerte
WI-343-005-WI-343-012
32.0 cm / 12 1/2"
malleable

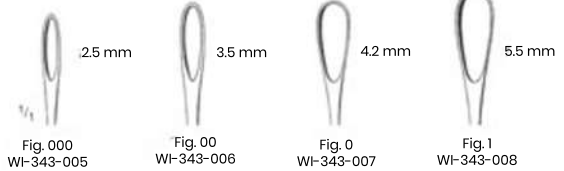

Fig. 000
WI-343-005

Fig. 00
WI-343-006

Fig. 0
WI-343-007

Fig. 1
WI-343-008

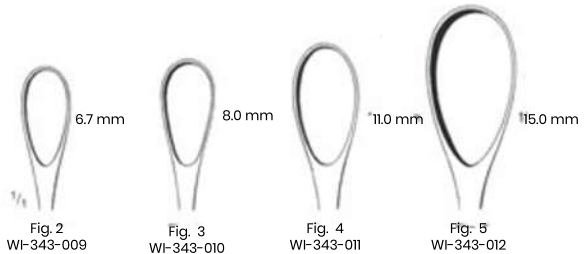

Fig. 2
WI-343-009

Fig. 3
WI-343-010

Fig. 4
WI-343-011

Fig. 5
WI-343-012

Liver, Gall, Bladder, Kidney Gall Stone Scoops



Moore
WI-344-013
28.0 cm / 11"



Mayo
WI-344-014
28.0 cm / 11"



WI-344-015
34.0 cm / 12 1/2"



Fergusson
WI-344-016-WI-344-018

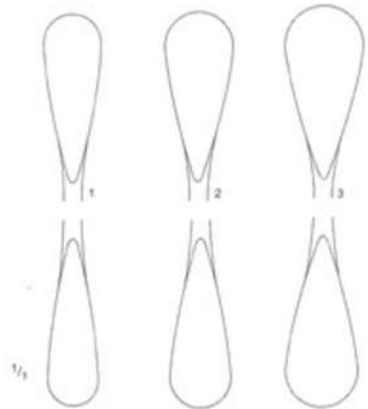

WI-344-016
21.0 cm / 8 1/2"

WI-344-017
22.0 cm / 8 3/4"

WI-344-018
23.5 cm / 9 1/4"

Bladder, Urology Prostatic Retractors

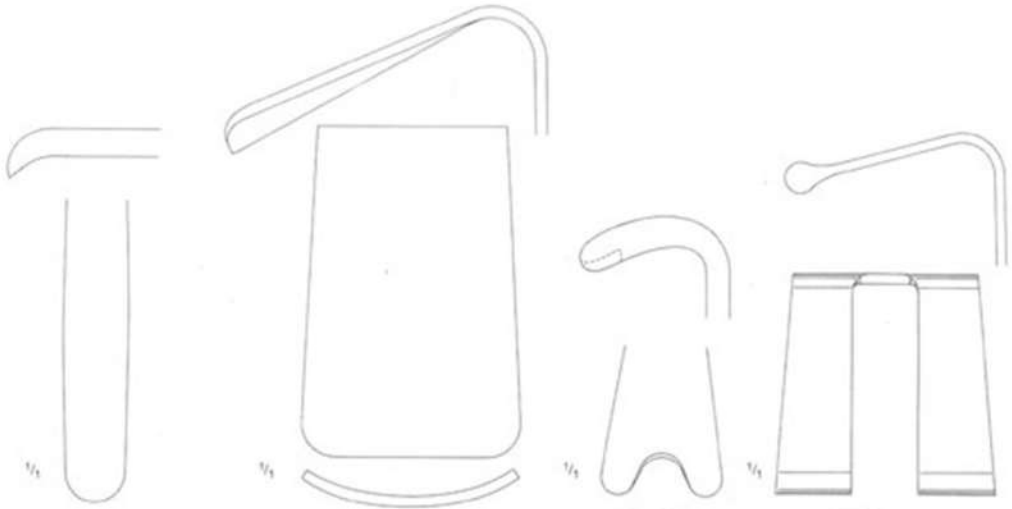

Young
WI-345-001
21.0 cm / 8 $\frac{1}{4}$ "



Young
WI-345-002
22.0 cm / 8 $\frac{3}{4}$ "



Young
WI-345-003
21.0 cm / 8 $\frac{1}{4}$ "



Young
WI-345-004
22.0 cm / 8 $\frac{3}{4}$ "

Bladder, Urology
Bladder Retractors

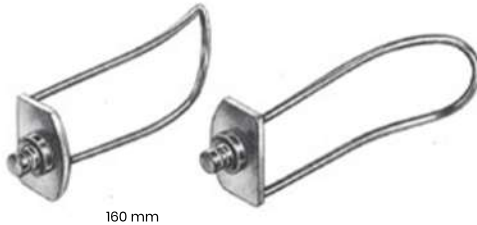

160 mm



63mm

1/2

Gosset
WI-346-001
Bladder Retractor



1/2

Millin
WI-346-002
Bladder Neck Retractor

Bladder, Urology Dilating Bougies, Metal Catheters

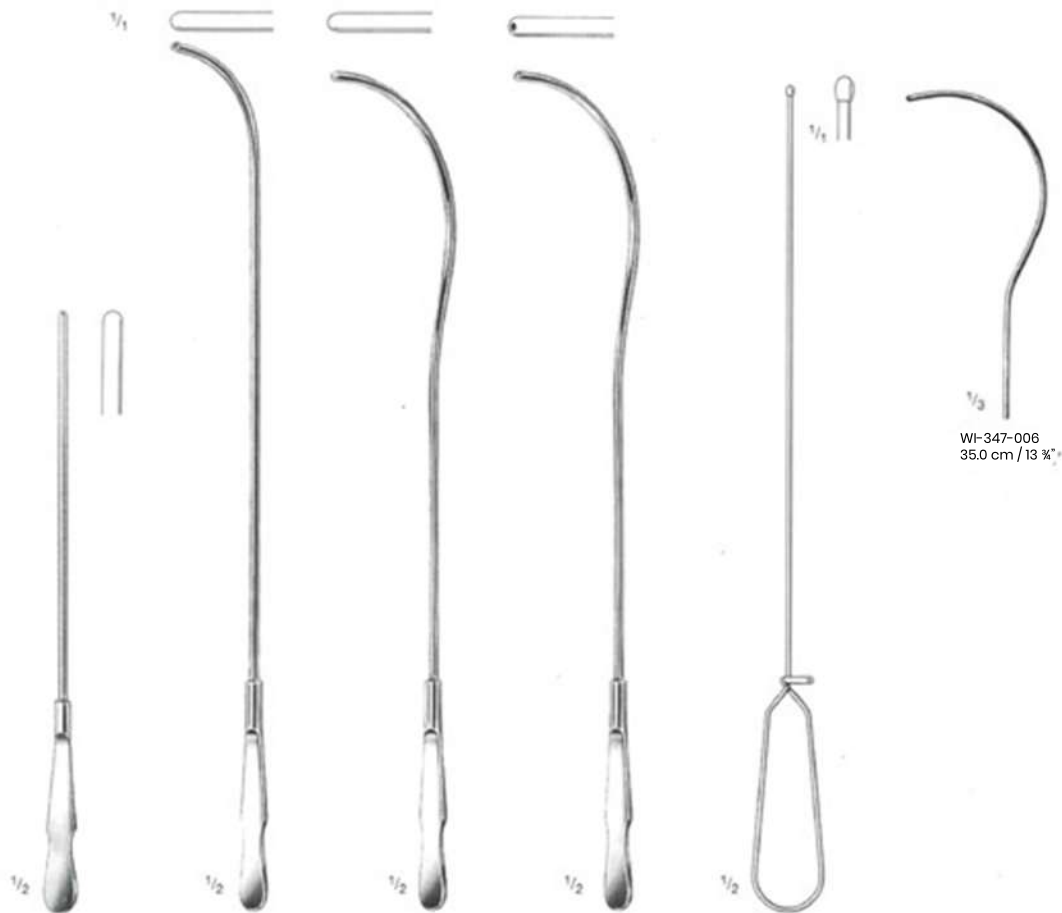

Ditten
WI-347-002
No. 8-30(French)

Van Buren
WI-347-002
No. 8-36(French)

Guyon
WI-347-003
No. 10-30(French)

Guyon
WI-347-004
No. 10-30(French)

Catheter
WI-347-005
39.0 mm / 1 1/2"
straight

WI-347-006
35.0 cm / 13 3/8"

Rectal and Gento Urinary Specula

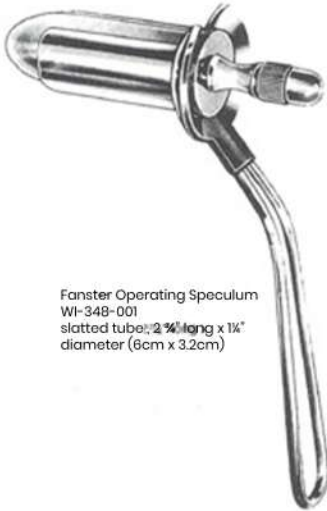

Fanster Operating Speculum
WI-348-001
slatted tube, 2 3/4" long x 1 1/4"
diameter (6cm x 3.2cm)

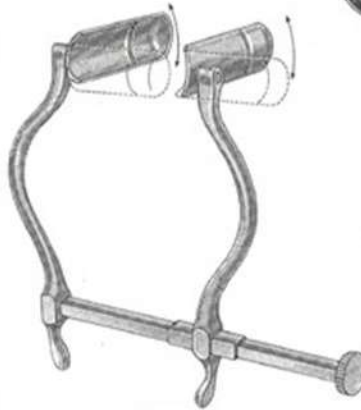

Smith Anal Retractor
WI-348-002
maximum opening 10.2 cm / 4"
swivel blades 2 3/4", deep x 7/8"
wide (7 cm x 2.2cm)



Barr Anal Retractor
WI-348-003
20.0 cm / 8", soft-retaining.
Blades 2 3/4" deep x 7/8"
wide (7 cm x 2.2cm)



Prat Rectal Speculum
WI-348-004
Blades 3 1/2" deep x 1" wide (8.9 cm x 2.5cm)
diameter at opening 1 3/4" (4.4 cm)



Bodenhammer Rectal Speculum
WI-348-005
Blades 3 1/2" deep x 3/4" wide (8.9 cm x 1.9cm)
diameter at opening 7/8" (2.2 cm)



Sims Rectal Speculum
WI-348-006
Blades 3 1/2" deep x 7/8" wide (8.9 cm x 2.2cm)
diameter at opening 7/8" (1.6 cm), fenestrated

Rectal and Gento Urinary Specula



fanster (Ives) Rectal Speculum
WI-349-007
3 1/4" long x 1" diameter (8.3 cm x 2.5 cm)



Hirschman Anascopes
WI-349-013
Small - 2 1/2" long x 9/16" diameter (6.4 cm x 1.4 cm)
WI-349-014
Medium- 2 3/4" long x 1 1/16" diameter (7 cm x 1.7 cm)
WI-349-015
Large - 3 1/2" long x 7/8" diameter (8.9 cm x 2.2 cm)



Chelsea-Eaton Anal Specula
WI-349-008
Small - 2 1/2" long x 7/8" diameter (6.4 cm x 2.2 cm).
WI-349-009
Large - 2 1/2" long x 1 3/16" diameter (6.4 cm x 3.1 cm)



Brinkerhoff Rectal Specula
WI-349-016
Small-2 1/2" long x 1" diameter (8.9 cm x 2.5 cm), tapering to 1/2" (1.3 cm)
WI-349-017
Medium- 4" long x 1" diameter (10.2 cm x 2.5 cm) tapering to 3/8" (1.6 cm)
WI-349-018
Large - 4 1/4" long x 1/4" diameter (12.1 cm x 3.2 cm) tapering to 3/4" (1.9 cm)

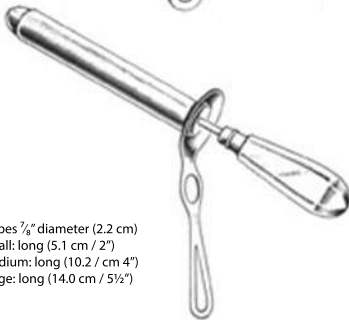

Kelly Proctoscopes 7/8" diameter (2.2 cm)
WI-349-010-Small: long (5.1 cm / 2")
WI-349-011-Medium: long (10.2 / cm 4")
WI-349-012-Large: long (14.0 cm / 5 1/2")



Kelly Sphincteroscopes
WI-349-019-2" long x 1" diameter (5.1 x 2.5 cm)
tapering to 1 1/16" (2.1 cm)

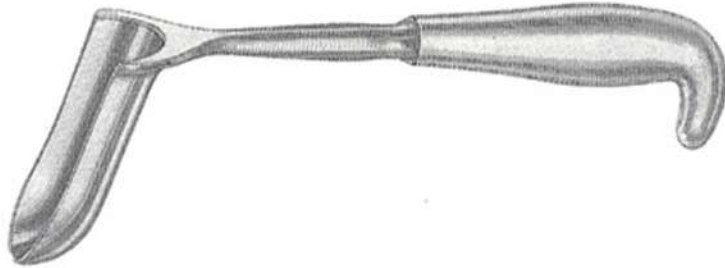

Hill-Ferguson Rectal Retractors

WI-350-020-Small: $2\frac{1}{2}$ " x $\frac{7}{8}$ " wide (6.4 cm x 2.2cm) blade

WI-350-021-Large: 3 " x $\frac{3}{4}$ " wide (7.6 cm x 3cm) blade

WI-350-022-Large: 3 " x $\frac{7}{8}$ " wide (7.6 cm x 3.6cm) blade

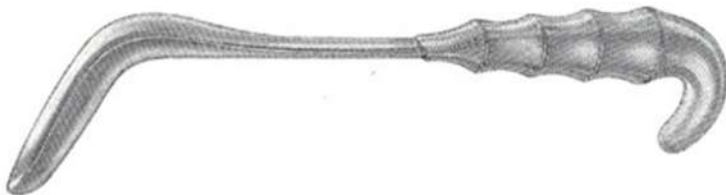

Sawyer Rectal Retractors

WI-350-023-Small: $2\frac{1}{2}$ " x $\frac{7}{8}$ " wide (6.4 cm x 2.2cm) blade

WI-350-024-Medium: 3 " x $\frac{1}{4}$ " wide (7.6 cm x 2.9cm) blade

WI-350-025-Large: $3\frac{1}{2}$ " x $\frac{1}{2}$ " wide (8.9 cm x 3.8cm) blade

Tracheotomy Trachea Dilators and Trachea Tubes



Laborde
WF-35F-001
14.0 cm / 5½"



Trousseau
WF-35F-002
14.0 cm / 5½"



Bose
WF-35F-003
7.0 cm / 2¾"

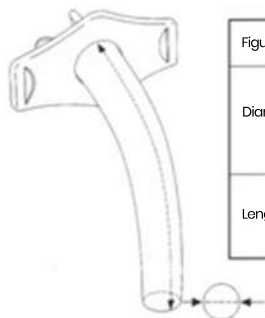

Jackson-Trachea Tubes
WF-35F-004 - W-35F-013

| International Scale | WF-35F-004 | WF-35F-005 | WF-35F-006 | WF-35F-007 | WF-35F-008 | WF-35F-009 | WF-35F-010 | WF-35F-011 | WF-35F-012 | WF-35F-013 |
|----------------------|------------|------------|------------|------------|------------|------------|------------|------------|------------|------------|
| Figure | 0 | 1 | 2 | 3 | 4 | 5 | 6 | 7 | 8 | 9 |
| Diameter | 4 | 5 | 6 | 7 | 8 | 9 | 10 | 11 | 12 | 13mm |
| Length of outer tube | 45 | 50 | 55 | 60 | 65 | 70 | 75 | 80 | 85 | 90mm |

Length
from shield along outer
curvature to end of tube

Diameter (Ø)
at the end of the outer tube
in millimeters



Ferguson
 WI-352-001 - 25 mm Ø
 WI-352-002 - 30 mm Ø
 WI-352-003 - 35 mm Ø

* Metal Specula, tubular shape



Collin
 WI-352-004
 5 x 10 mm



Cusco
 WI-352-005 - 75 x 32 mm
 WI-352-006 - 85 x 35 mm
 WI-352-007 - 100 x 35 mm
 Vaginal Specula with lateral
 ratchet, with folding handles

WI-352-008 - 85 x 35 mm
 * with interchangeable fiber optic light carrier
 * fiber optic light carrier



Cusco
 WI-352-009
 75 x 17 mm
 conical shape, virgin size



Cusco
 WI-353-010 - 80 x 22 mm
 WI-353-011 - 100 x 25 mm
 WI-353-012 - 105 x 27 mm

* Swiss pattern, narrow, with lateral ratchet, with holding handles



Cusco
 WI-353-013 - 75 x 32 mm
 WI-353-014 - 85 x 35 mm
 WI-353-015 - 100 x 37 mm

* with ratchet at the folding handles



Collin
 WI-353-016
 65 x 20 mm



Collin
 WI-353-017 - 85 x 30 mm
 WI-353-018 - 100 x 35 mm
 WI-353-019 - 110 x 40 mm
 WI-353-020 - 100 x 35 mm

* detachable
 * with interchangeable fiber optic light carrier

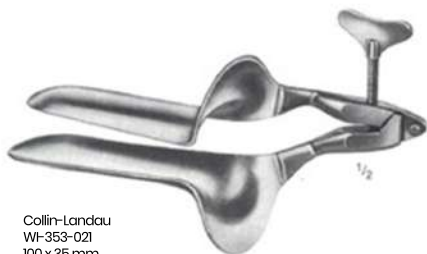

Collin-Landau
 WI-353-021
 100 x 35 mm



Trélat
 WI-353-022 - 85 x 33 mm
 WI-353-023 - 95 x 35 mm
 WI-353-024 - 115 x 43 mm

* detachable, with folding handles

Gynecology Vaginal Specula

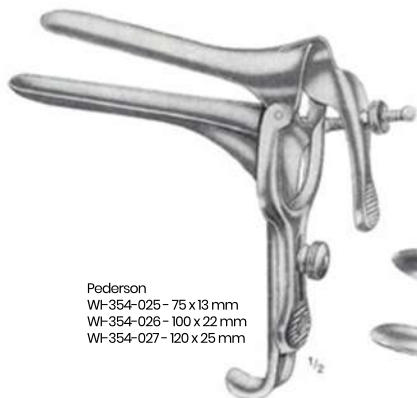

Pederson
 WI-354-025 - 75 x 13 mm
 WI-354-026 - 100 x 22 mm
 WI-354-027 - 120 x 25 mm



Graves
 WI-354-028 - 75 x 20 mm
 WI-354-029 - 95 x 35 mm
 WI-354-030 - 115 x 35 mm



Semm
 WI-354-031 - 100 x 17/20 mm
 WI-354-032 - 100 x 25/30 mm



Kristeller Specula

- Fig1 WI-354-033 - 70 x 27 mm
- Fig2 WI-354-034 - 80 x 30 mm
- Fig3 WI-354-035 - 90 x 36 mm



Kristeller Retractors

- Fig1 WI-354-036 - 75 x 23 mm
- Fig2 WI-354-037 - 85 x 26 mm
- Fig3 WI-354-038 - 100 x 32 mm



Kristeller
 Set of 1 Spectulum
 and 1 Retractor each
 Fig1 WI-354-039
 Fig2 WI-354-040
 Fig3 WI-354-041

Gynecology Vaginal Specula



Sims

WF-355-042 - 65 x 25 mm
- 70 x 30 mm
WF-355-043 - 70 x 30 mm
- 70 x 35 mm
WF-355-044 - 85 x 35 mm
- 90 x 40 mm

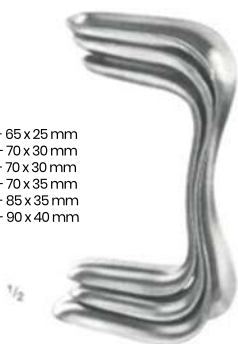

Jackson

WF-355-045 - 75 x 35 mm
WF-355-046 - 90 x 35 mm
WF-355-047 - 100 x 35 mm
WF-355-048 - 75 x 40 mm
WF-355-049 - 90 x 40 mm
WF-355-050 - 100 x 40 mm



with conically shaped blades, virgin size



Kristeller Specula
WF-355-051 - 105 x 18 mm
WF-355-052 - 105 x 21 mm



Kristeller Retractors
WF-355-053 - 10 x 14 mm
WF-35-054 - 110 x 17 mm



Kristeller
Set of 1 Spectulum and 1 Retractor
WF-355-055
WF-355-056

Gynecology Vaginal Specula

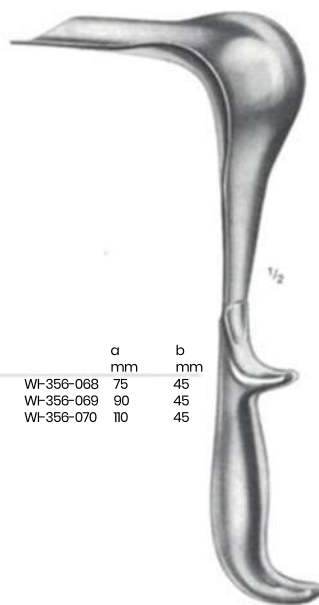
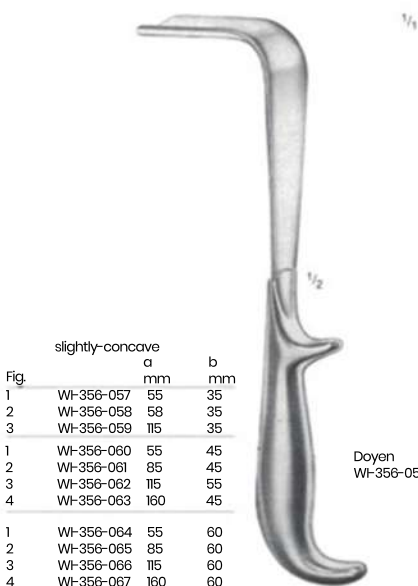
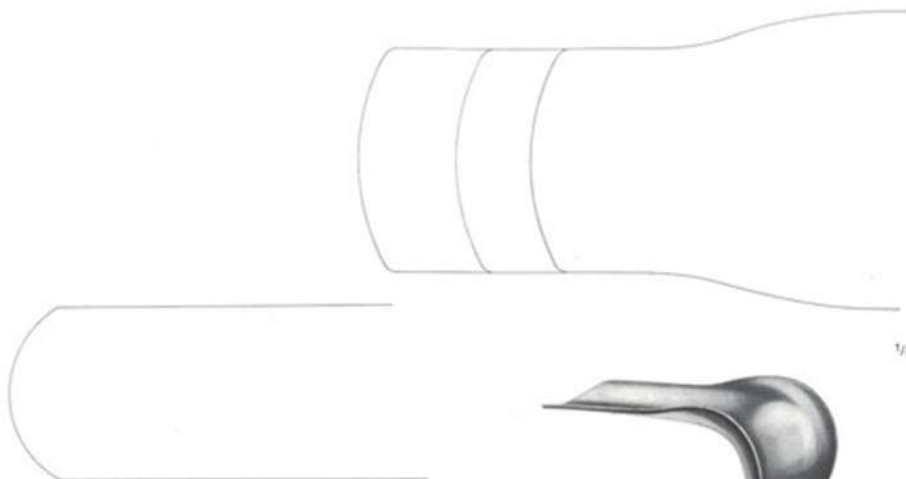

| Fig. | | slightly-concave a mm | b mm |
|------|------------|-----------------------------|---------|
| 1 | WI-356-057 | 55 | 35 |
| 2 | WI-356-058 | 58 | 35 |
| 3 | WI-356-059 | 115 | 35 |
| 1 | WI-356-060 | 55 | 45 |
| 2 | WI-356-061 | 85 | 45 |
| 3 | WI-356-062 | 115 | 55 |
| 4 | WI-356-063 | 160 | 45 |
| 1 | WI-356-064 | 55 | 60 |
| 2 | WI-356-065 | 85 | 60 |
| 3 | WI-356-066 | 115 | 60 |
| 4 | WI-356-067 | 160 | 60 |

| Fig. | | a mm | b mm |
|------|------------|---------|---------|
| 1 | WI-356-068 | 75 | 45 |
| 2 | WI-356-069 | 90 | 45 |
| 3 | WI-356-070 | 110 | 45 |

Doyen
WI-356-057 - WI-356-067

Doyen
WI-356-068 - WI-356-070



Samuel
WI-357-071 - WI-357-072

Samuel
WI-357-071

* complete, with removable weight and metal strainer with perforated bottom for retaining specimen

Samuel
WI-357-072

* Metal Strainer with perforated bottom only



Auvard
WI-357-073

* complete, with removable weight



70 x 30 mm



Doyen Vaginal Speculum
Wt-358-074
24.0 cm / 9 1/2"



O'Sullivan-O'Connors
Wt-385-075

* Vaginal Speculum, for examination and operative work, self-retaining, with adjustable frame, Loktite ratchet, 2 mobile lateral blades and 3 interchangeable blades fig.1-3.



Fig.1= 45 x 17 mm
Fig.2= 90 x 37 mm
Fig.3= 90 x 45 mm

Gynecology Retractors, Endospecula



Friedman
WI-359-076
10.0 cm / 4"

* Retractor, self-retaining, for perineorrhaphy



Kogan
WI-359-077
24.0 cm / 9 1/2"

* without ratchet



Kogan
WI-359-078
24.0 cm / 9 1/2"

* with scale-ratchet and fixing screws

Gynecology Uterine Dilators



1/2

| Pieces per set | Set | |
|----------------|------------|------------|
| 14 | 4.0 - 17.0 | WI-360-001 |
| 26 | 1.0 - 26.0 | WI-360-002 |

Gynecology Uterine Dilators



WI-361-003 - WI-361-004

WI-361-003
Set of 14 dilators
(4.0 - 17.0 mm \varnothing), in metal case with hinged lid

WI-361-004
Set of 26 dilators
(10 - 26.0 mm \varnothing), in metal case with hinged lid



WI-361-005
Set of 8 dilators
(3.0/4.0 - 17.0/18.0 mm \varnothing).

WI-361-006
Set of 13 dilators
(10-2.0 - 25.0/26.0 mm \varnothing).



WI-362-007

WI-362-007
Set of 8 dilators
(3.0/4.0 - 17.0/18.0 mm ϕ)
in boilable canvas roll

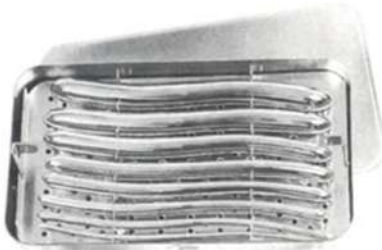

WI-362-008

WI-362-008
Set of 8 dilators
(3.0/4.0 - 17.0/18.0 mm ϕ)
in metal case with hinged lid



WI-362-009

WI-362-009
Set of 13 dilators
(10/20 - 25.0/26.0 mm ϕ)
in metal case with hinged lid

Gynecology Uterine Sounds, Depressors and Tenaculum Forceps



maleable

maleable

Sims
WF-363-001
WF-363-002
32.0 cm / 12 1/2"

Special Model
WF-363-003
WF-363-004
32.0 cm / 12 1/2"

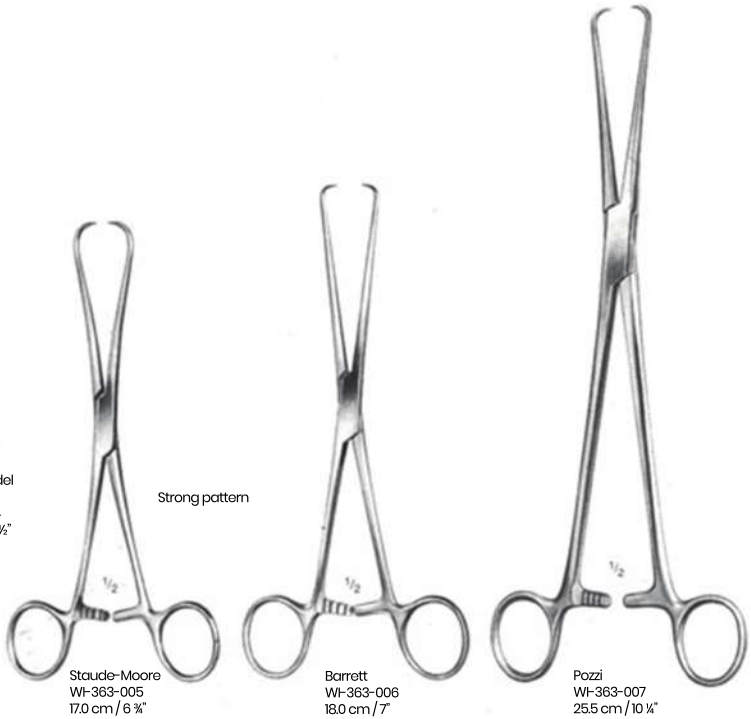

Strong pattern

Staude-Moore
WF-363-005
17.0 cm / 6 3/4"

Barrett
WF-363-006
18.0 cm / 7"

Pozzi
WF-363-007
25.5 cm / 10 1/4"



Schroeder
WF-364-008
25.0 cm / 10"



Braun
WF-364-009
25.0 cm / 10"



Duplay
WF-364-010
28.0 cm / 11"



Amniotome for the amnion bladder



Becham
WI-365-011
26.0 cm / 10 1/4"



Skene
WI-365-012
24.0 cm / 9 1/2"

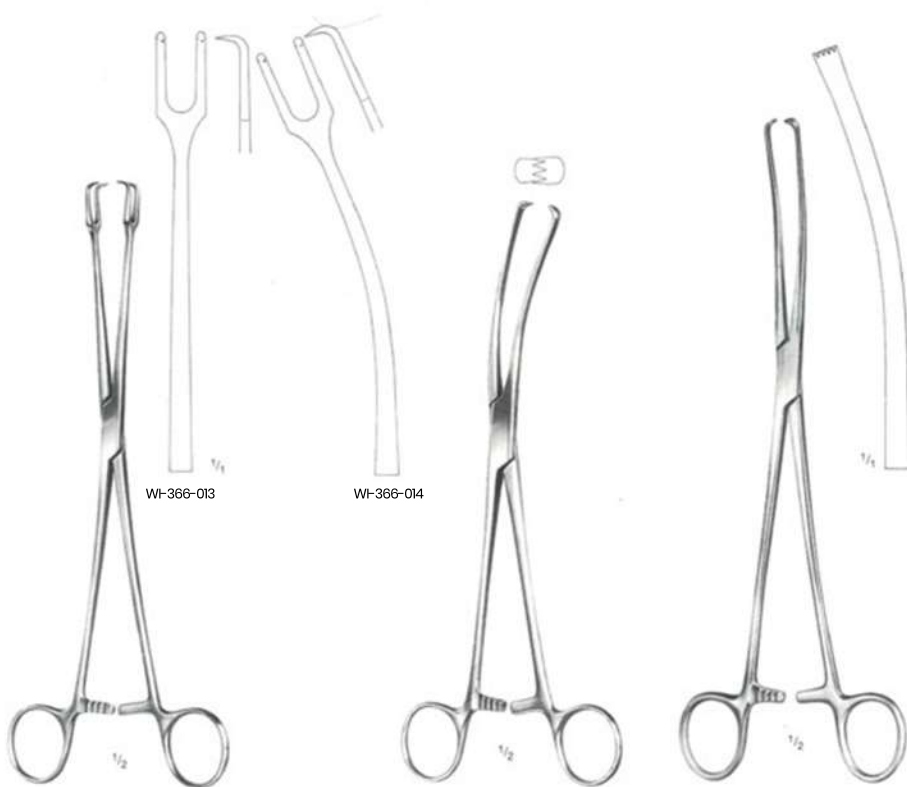

WI-366-013

WI-366-014

Schroeder
WI-366-013 - WI-366-014
24.0 cm / 9 1/2"

Teale
WI-366-015
23.0 cm / 9"

Iowa
WI-366-016
26.0 cm / 10 1/4"

for the amnion bladder

Gynecology Tenaculum Forceps



Museux
WI-367-017 - WI-367-019
24.0 cm / 9 1/2"



6 mm

WI-367-017



8 mm

WI-367-018



10 mm

WI-367-019



Museux
WI-367-020 - WI-367-021
24.0 cm / 9 1/2"

curved sideways



6 mm

WI-367-020



8 mm

WI-367-021

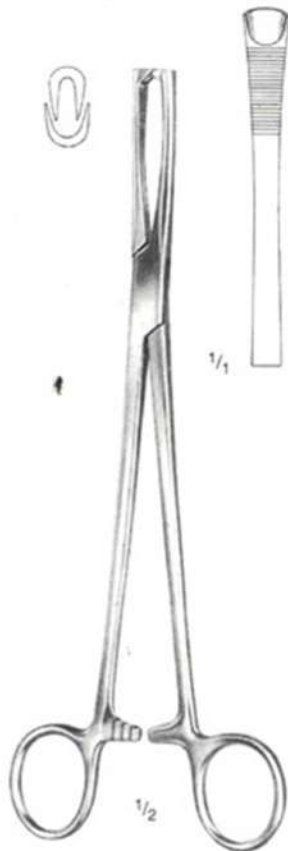

Jacobs
WJ-368-022
21.0 cm / 8 1/4"



Henrotin
WJ-368-023
20.5 cm / 8"

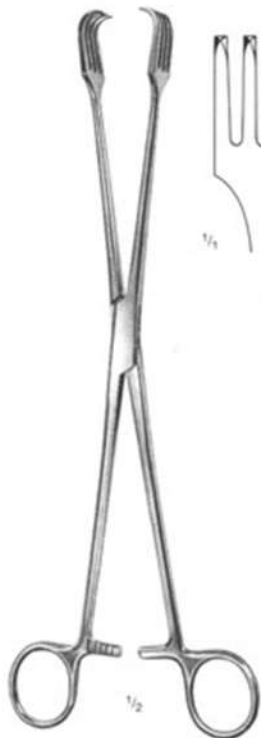

WI-369-024
26.0 cm / 10 1/4"



Braun
WI-369-025
16.0 cm / 6 1/4"



Czerny
WI-369-026
21.0 cm / 8 1/4"



Kelly
WI-370-001
32.0 cm / 12 1/2"



Noto
WI-370-002
27.0 cm / 10 1/2"



Doyen
WI-370-003
20.0 cm / 8"



Doyen
WI-371-001
17.0 cm / 6 3/4"



Doyen
WI-371-002
17.0 cm / 6 3/4"



Segond
WI-371-003

Gynecology

Uterine Elevating Forceps

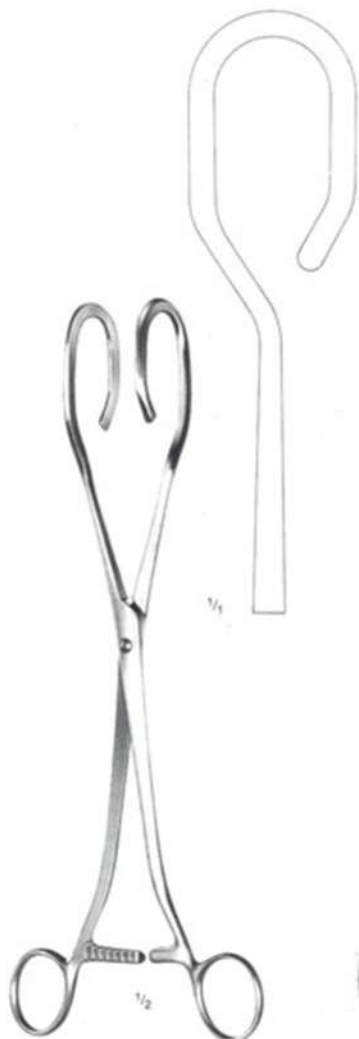

Dartingues
WI-372-001
27.0 cm / 10 1/2"



Somer
WI-372-002
23.0 cm / 9"



Colin
WI-372-003
25.0 cm / 10"

Gynecology Suction Biopsy Curettes



Randall
WF-373-001
24.0 cm / 9 1/2"
4 mm Ø



Novak
WF-373-002
23.0 cm / 9"
4 mm Ø



Kevorkian
WF-373-003
30.0 cm / 12"



Mod. Muenchen
WF-373-004
27.0 cm / 10 1/2"

Biopsy Curette

* Endometrial Suction Biopsy Curettes

Gynecology Cervical Biopsy and Specimen Forceps

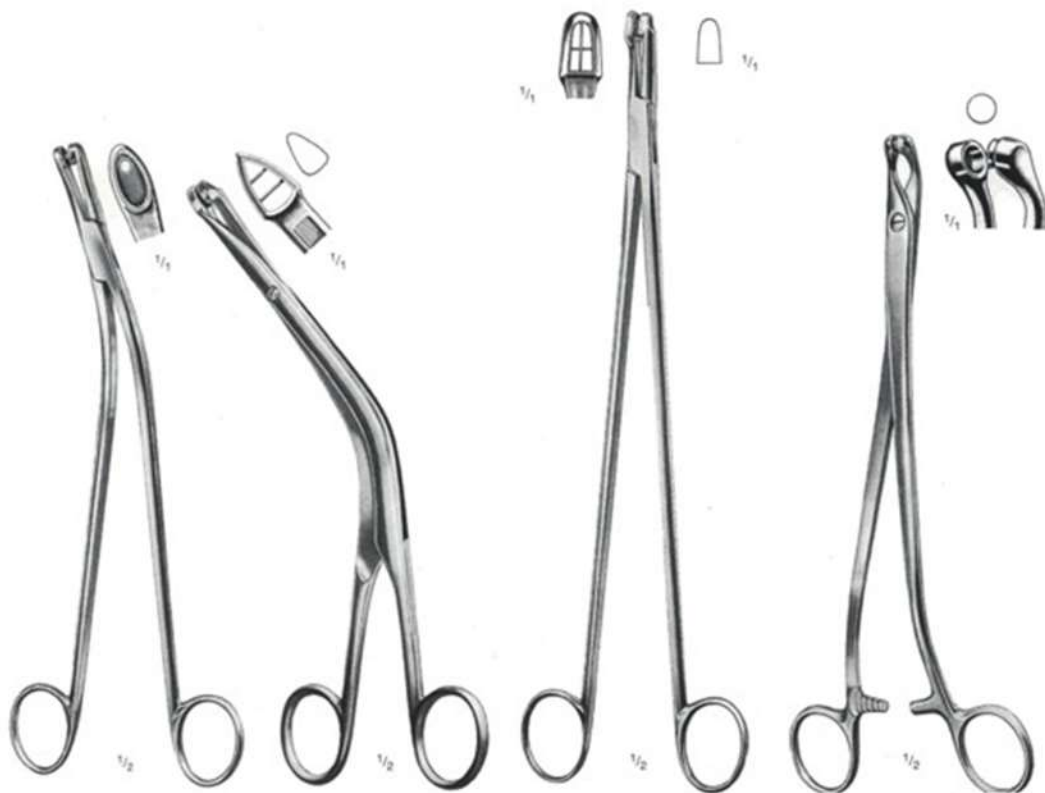

Gellhorn
WF-374-001
23.0 cm / 9"

Faure
WF-374-002
21.0 cm / 8 1/4"

Schubert
WF-374-003 - 21.0 cm / 8 1/4"
WF-374-004 - 29.0 cm / 11 1/2"

Thomas-Gaylor
WF-374-005
24.0 cm / 9 1/2"

Gynecology Cervical Biopsy and Specimen Forceps



Thomas-Gaylor
WF-375-006 - 22.0 cm / 8 1/2"
WF-375-007 - 24.0 cm / 9 1/2"



Schubert
WF-375-008
26.0 cm / 10 1/4"



Van Doren
WF-375-009
24.0 cm / 9 1/2"

Gynecology Cervical Biopsy and Specimen Forceps

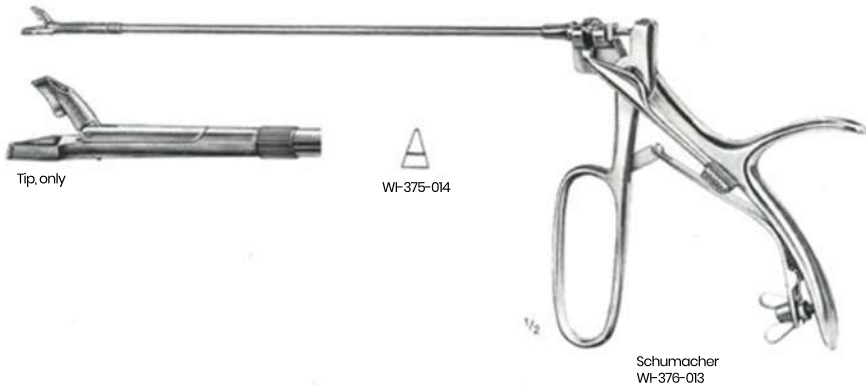
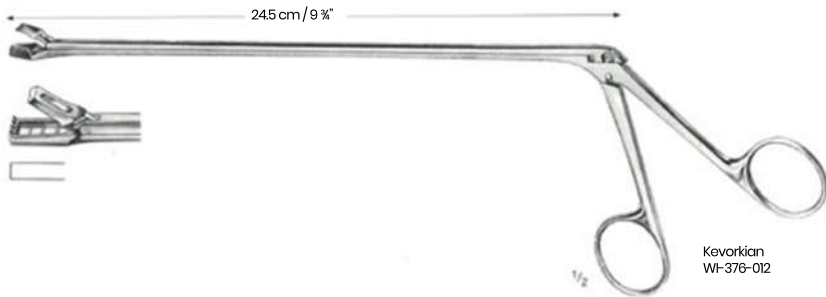
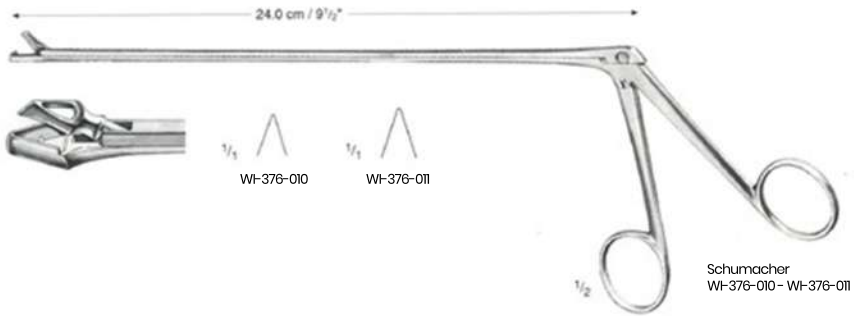

Gynecology Uterine Scoops



WI-377-001



WI-377-002



WI-377-003



WI-377-004



WI-377-005



WI-377-006

1/4

1/2



Simon
WI-377-001 - WI-377-006
25.0 cm / 10"

sharp, rigid



WI-377-007



WI-377-008



WI-377-009



WI-377-010



WI-377-011



WI-377-012

1/4

1/2



Schroeder
WI-377-007 - WI-377-012
30.0 cm / 12"

sharp, rigid

Gynecology Uterine Curettes



sharp



Recamier-Sims-Bumm
Wt-376-001
31.0 cm / 12 1/2"
Fig. 00-16
rigid

Recamier-Sims-Bumm
Wt-376-002
31.0 cm / 12 1/2"
Fig. 00-16
malleable

blunt



Recamier-Sims-Bumm
Wt-376-003
31.0 cm / 12 1/2"
Fig. 00-16
rigid

Recamier-Sims-Bumm
Wt-376-004
31.0 cm / 12 1/2"
Fig. 00-16
rigid



Sharp Curettes
(Recamier Handle)



Malleable Curettes
(grooved shaft)



Rigid Curettes
(plain shaft)



Blunt Curettes
(Sims Handle)

Gynecology Uterine Curettes

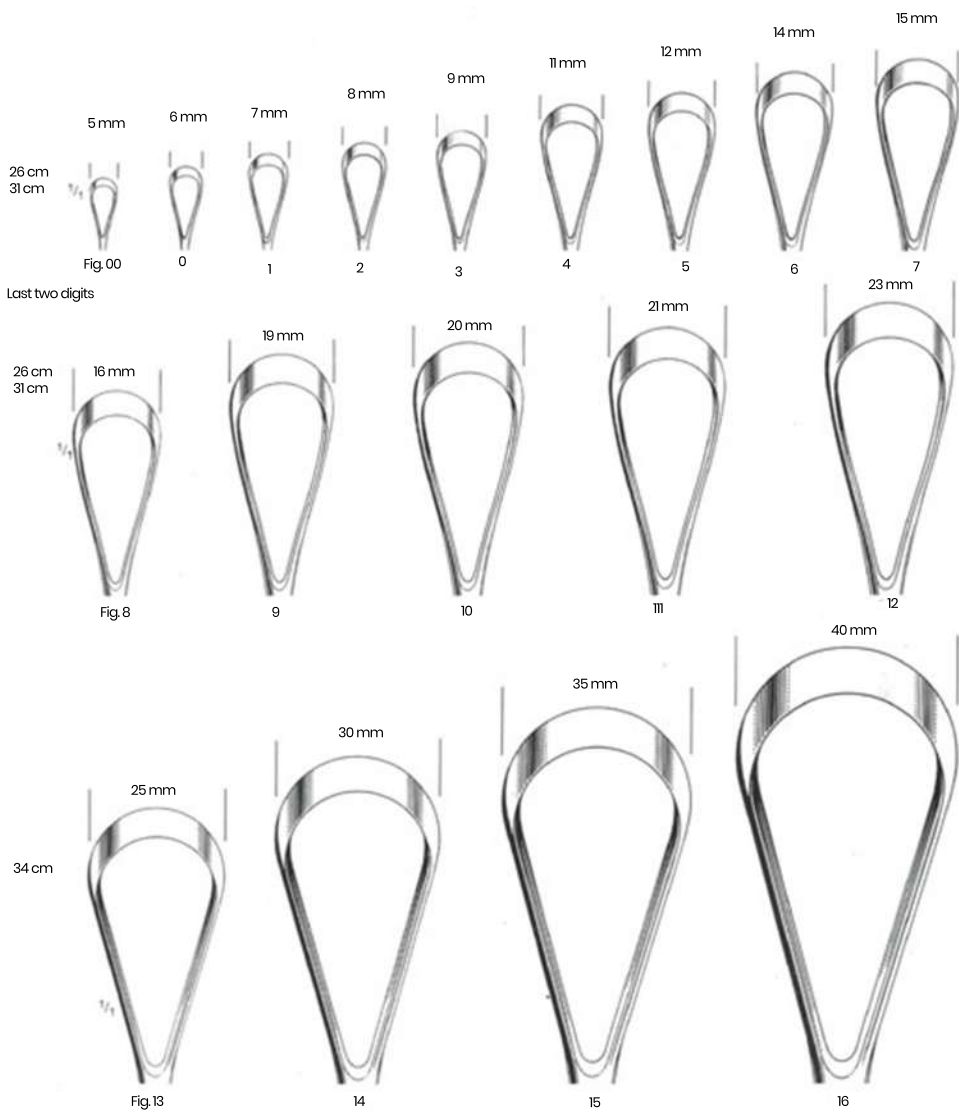

Recamier-Sims-Bumm

Obstetrics Pelvimeters and Obstetrical Forceps



Special Model
WF-380-001
34.0 cm / 13½"
cm/inch scale



Collin
WF-380-002
35.0 cm / 13¾"
cm scale



Briesky
WF-380-003
33.0 cm / 13"
cm/inch scale



Naegle
WF-380-004-36.0cm / 14"
WF-380-005-40.0 cm / 16"



Simpson
WF-380-005
30.0cm / 12"



Simpson-Braun
WF-380-006
36.0cm / 14"



Simpson-Lulkart
WF-380-008
36.0cm / 14"

Obstetrics

Obstetrical Forceps



De Lee
WF-38F-009
30.0 cm / 12"



De Lee
WF-38F-010 - 36.0 cm / 14"
WF-38F-011 - 39.0 cm / 15½"



Elliot
WF-38F-012
32.0 cm / 12½"
WF-38F-013
38.0 cm / 15"



Mc Lean
WF-38F-014
36.0 cm / 14"



Kielland
WF-38F-015
41.0 cm / 16"



Kielland-Luskart
WF-38F-016
40.0 cm / 15 ¾"



Piper
WF-38F-017
44.0 cm / 17 ¼"

Obstetrics Scalp Flap Forceps, Elevating Spoon, ETC.

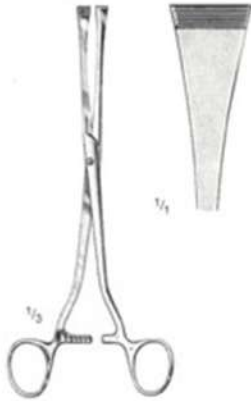

Green-Armytage
WF-382-001
21.0 cm / 8 1/4"



Sellheim
WF-382-002
28.0 cm / 11"



WF-382-003

WF-382-004

Scenger
WF-382-003 - WF-382-004
27.0 cm / 10 1/2"

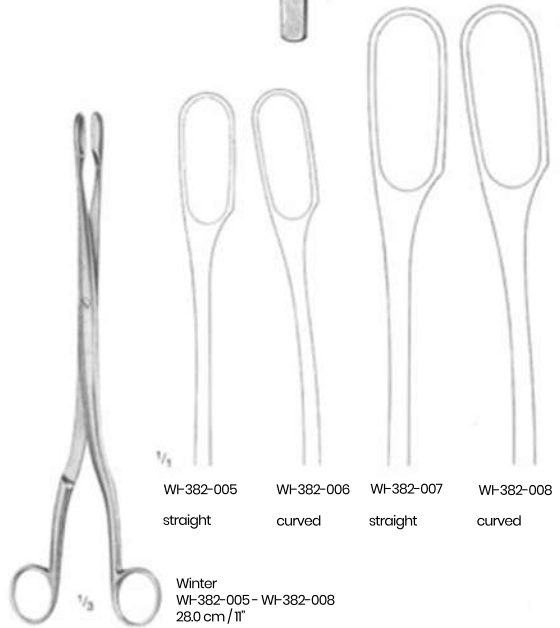

WF-382-005

WF-382-006

WF-382-007

WF-382-008

straight

curved

straight

curved

Winter
WF-382-005 - WF-382-008
28.0 cm / 11"



McKenzie
WF-383-001 - 15.0 cm / 6"
WF-383-002 - 19.0 cm / 7 1/2"



McKenzie
WF-383-003 - 15.0 cm / 6"
WF-383-004 - 19.0 cm / 7 1/2"

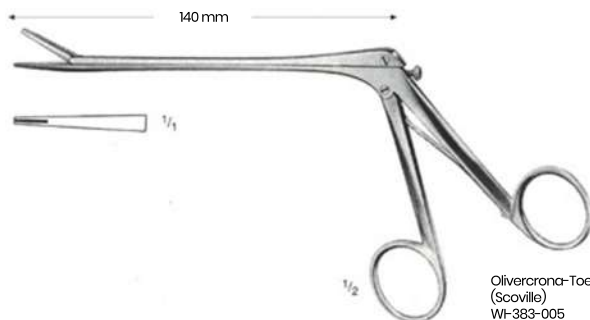

Olivercrona-Toennis
(Scoville)
WF-383-005

Neurosurgery Galea Hooks

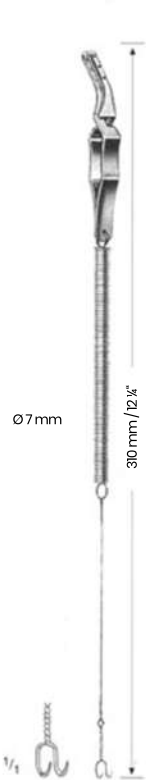
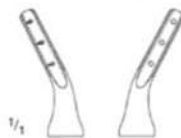

Ø7 mm

310 mm / 12 1/4"

Yasargil
WI-384-001
310 cm / 12 1/4"

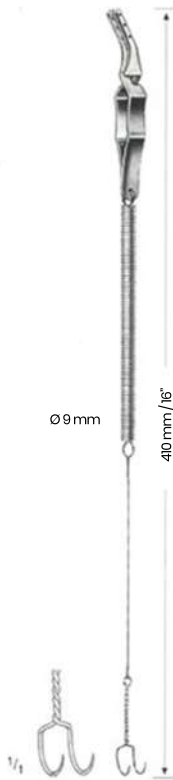

Ø9 mm

410 mm / 16"

Yasargil
WI-384-002
410 cm / 16"



Penfield
WF-385-001
17.5 cm / 7"
Fig. 1

Penfield
WF-385-002
18.5 cm / 7 3/8"
Fig. 2

Penfield
WF-385-003
19.5 cm / 7 3/4"
Fig. 3

Penfield
WF-385-004
21.5 cm / 8 1/2"
Fig. 4

Penfield
WF-385-005
29.0 cm / 11 1/2"
Fig. 5



Davis
WF-386-006
24.5 cm / 9 3/4"



Frazier
WF-386-007
15.0 cm / 6"



Hoen
WF-386-008
15.0 cm / 6"



Hoen
WF-386-009
15.0 cm / 6"

Neurosurgery Nerve Root, Retractors, Dura Dissectors

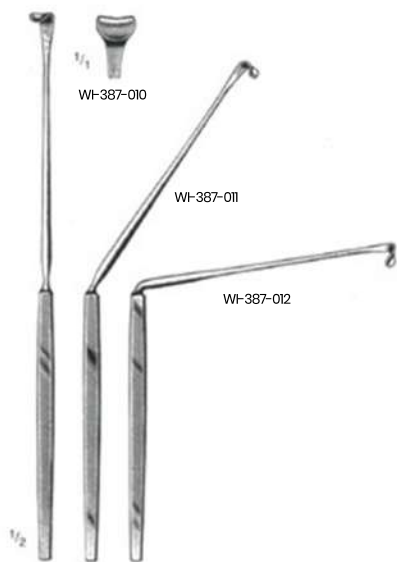

Love
WF-387-010 - WF-387-012



Horsley
WF-387-013
20.0 cm / 8"



Sachs
WF-387-014
21.0 cm / 8 1/4"

Neurosurgery Brain Spatulas



Heifetz
20.0 cm / 8"

Malleable

- WI-388-001 - 8 mm
- WI-388-002 - 11 mm
- WI-388-003 - 14 mm
- WI-388-004 - 17 mm
- WI-388-005 - 20 mm



Cushing
WI-388-006 - WI-388-008

WI-388-006
17.0 cm / 6 3/4"
8 x 10 mm

WI-388-007
20.0 cm / 8"
13 x 15 mm

WI-388-008
28.0 cm / 11"
16 x 18 mm



Olivercrona
WI-388-009 - WI-388-016
18.0 cm / 7"

width of spatulas

| concave | upper end mm | lower end mm | convex |
|------------|-----------------|-----------------|------------|
| WI-388-009 | 7 | 9 | WI-388-013 |
| WI-388-010 | 11 | 13 | WI-388-014 |
| WI-388-011 | 15 | 18 | WI-388-015 |
| WI-388-012 | 18 | 22 | WI-388-016 |

Neurosurgery Nerve Root Retractors

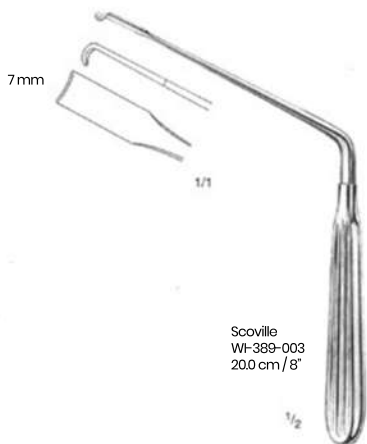

Neurosurgery Nerve Hooks



Cushing
WF-390-001 - 19.0 cm / 7 1/2"
WF-390-002 - 28.0 cm / 11"



Cushing
WF-390-003 - 19.0 cm / 7 1/2"
WF-390-004 - 28.0 cm / 11"



WF-390-005
17.0 cm / 6 3/4"



WF-390-006
21.0 cm / 8 1/4"



Smithwick
WF-390-005 - WF-390-006



Smithwick
WF-390-007
29.0 cm / 11 1/2"



Scoville
WF-390-008
30.0 cm / 12"



Scoville
WF-390-009
30.0 cm / 12"

Neurosurgery Elevators, Knives, Dura Hooks

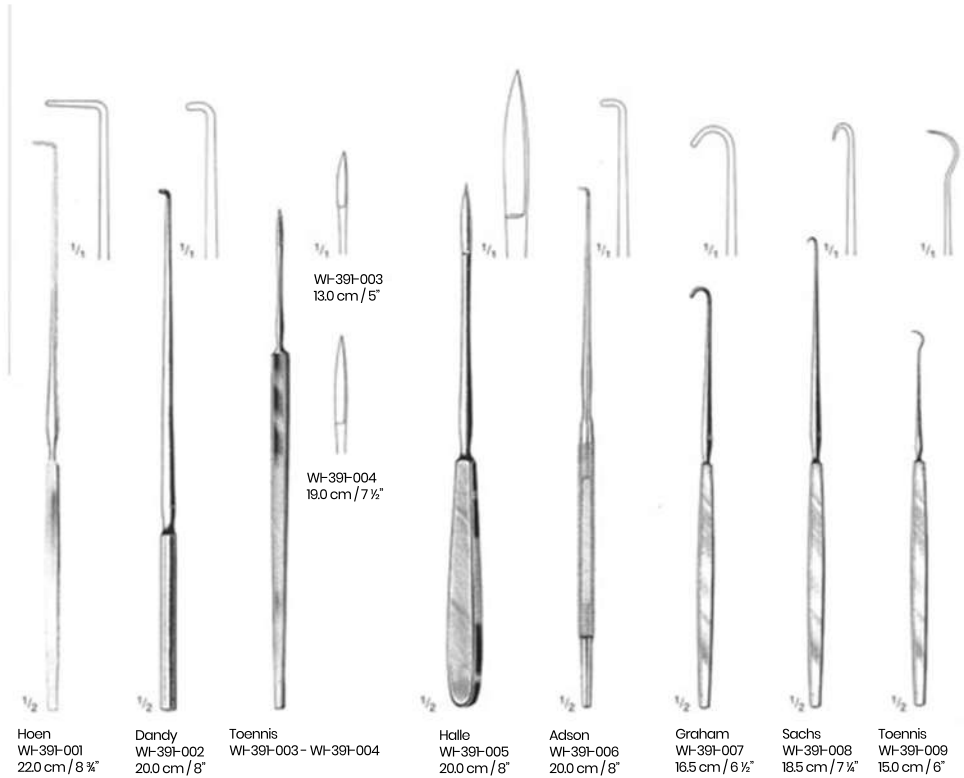

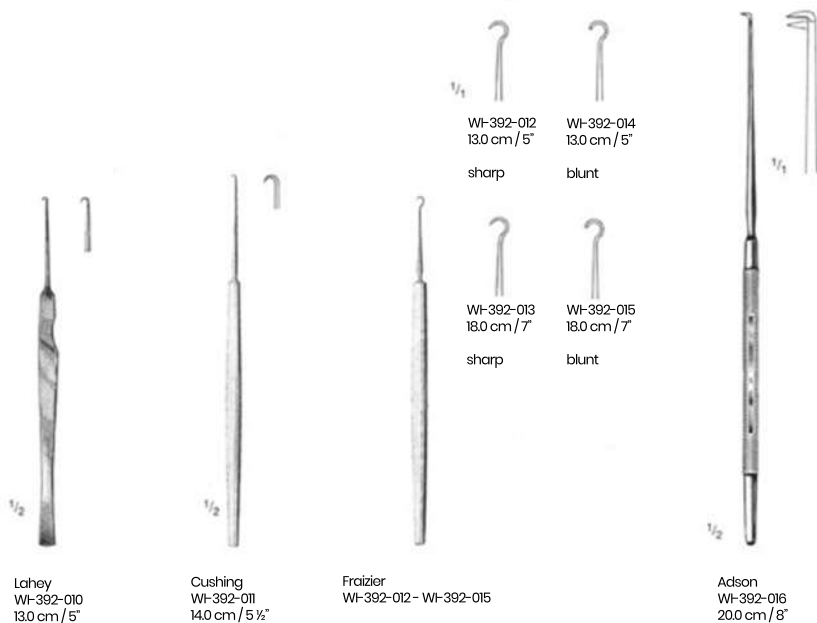

Neurosurgery Lamina Spreaders



Cloward
WF-393-001
16.0 cm / 6 1/4"

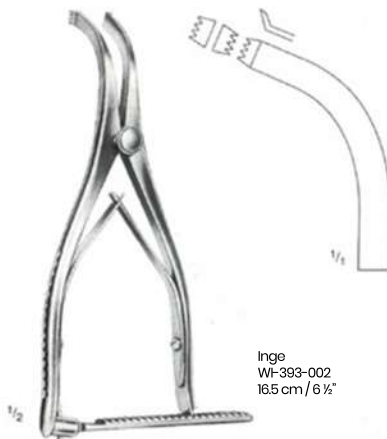

Inge
WF-393-002
16.5 cm / 6 1/2"

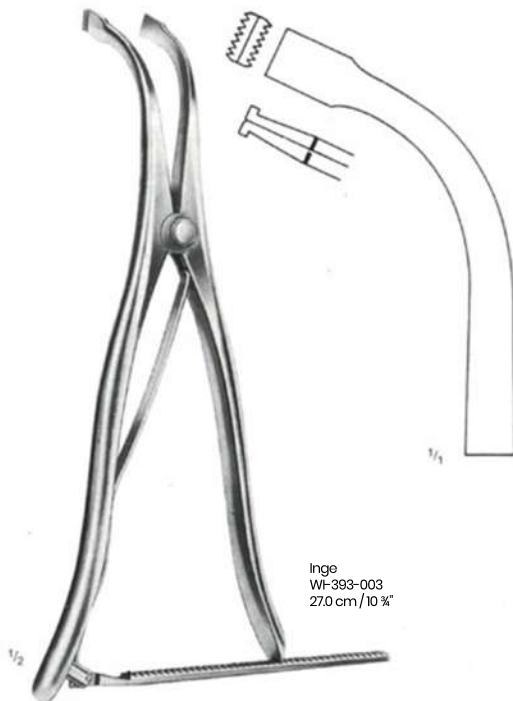

Inge
WF-393-003
27.0 cm / 10 3/4"

Neurosurgery Intervertebral Disc Rongeur With Exchangeable Tips



WI-394-003
width of jaw 4 mm



WI-394-004
width of jaw 5 mm



WI-394-005
width of jaw 6 mm

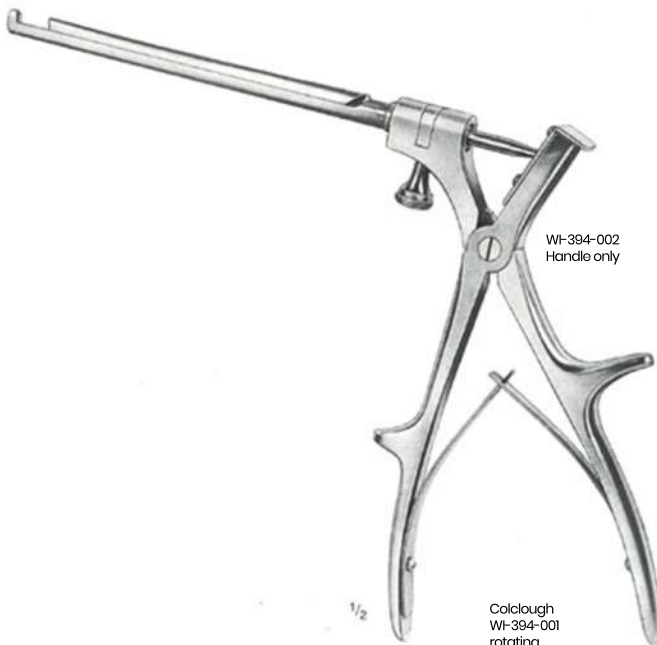

WI-394-002
Handle only

Colclough
WI-394-001
rotating

Consists of 3 interchangeable tips

Neurosurgery Intervertebral Disc Rongeurs



| | | | | |
|-----------------|--------------|--------------|--------------|--------------|
| Length of shaft | 150 mm 6" | 150 mm 6" | 200 mm 8" | 200 mm 8" |
| Width of bite | 3 mm | 5 mm | 3 mm | 5 mm |
| Cat. Ref. | WI-395-001 | WI-395-002 | WI-395-003 | WI-395-004 |

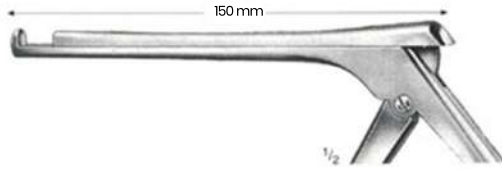

Colclough
WI-395-001 - WI-395-002

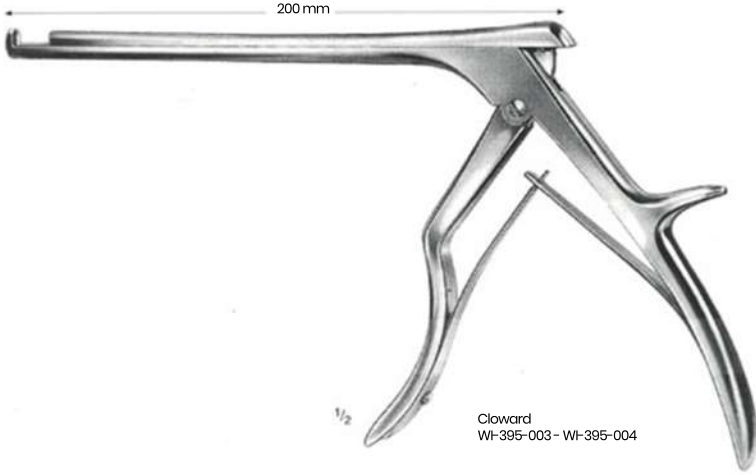

Cloward
WI-395-003 - WI-395-004

Neurosurgery Intervertebral Disc Rongeurs



| | | | | |
|-----------------|--------------|--------------|--------------|--------------|
| Length of shaft | 150 mm 6" | 150 mm 6" | 200 mm 8" | 200 mm 8" |
| Width of bite | 3 mm | 5 mm | 3 mm | 5 mm |
| Cat. Ref. | WF-396-005 | WF-396-006 | WF-396-007 | WF-396-008 |

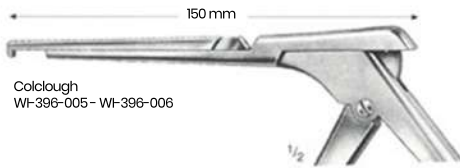

Colclough
WF-396-005 - WF-396-006

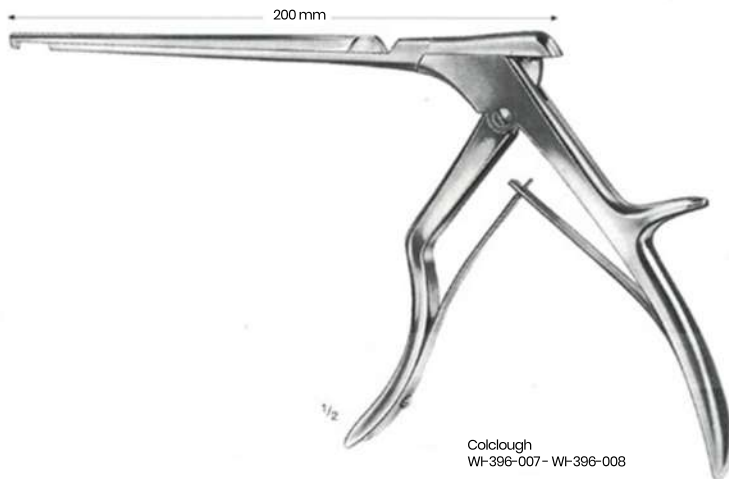

Colclough
WF-396-007 - WF-396-008

Neurosurgery Intervertebral Disc Rongeurs



| | | | | |
|-----------------|--------------|--------------|--------------|--------------|
| Length of shaft | 150 mm 6" | 150 mm 6" | 200 mm 8" | 200 mm 8" |
| Width of bite | 3 mm | 5 mm | 3 mm | 5 mm |
| Cat. Ref. | WI-397-009 | WI-397-010 | WI-397-011 | WI-397-012 |

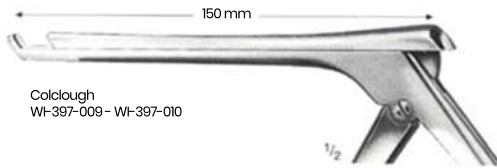

Colclough
WI-397-009 - WI-397-010



Colclough (Richter)
WI-397-011 - WI-397-012

Neurosurgery Intervertebral Disc Rongeurs

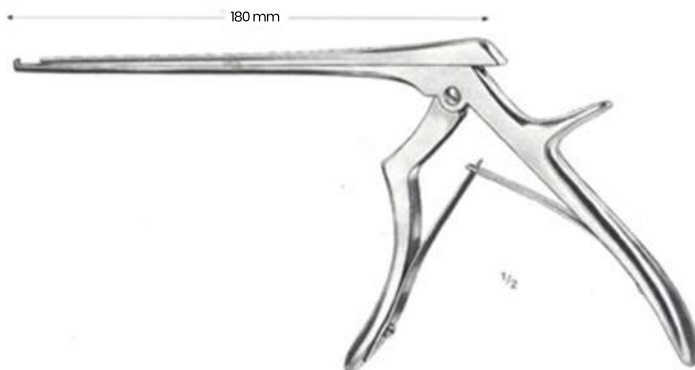









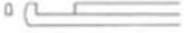

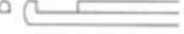



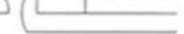

Ferris-Smith-Kerison
WI-398-001 - WI-398-018
18.0 cm / 7 cm shaft

cutting upward

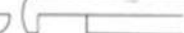
cutting downward

cutting 40° forward

| | | |
|--|--|---|
|  WI-398-001 1 mm |  WI-398-007 1 mm |  WI-398-013 1 mm |
|  WI-398-002 2 mm |  WI-398-008 2 mm |  WI-398-014 2 mm |
|  WI-398-003 3 mm |  WI-398-009 3 mm |  WI-398-015 3 mm |
|  WI-398-004 4 mm |  WI-398-010 4 mm |  WI-398-016 4 mm |
|  WI-398-005 5 mm |  WI-398-011 5 mm |  WI-398-017 5 mm |
|  WI-398-006 6 mm |  WI-398-012 6 mm |  WI-398-018 6 mm |

Neurosurgery Laminectomy Rongeurs

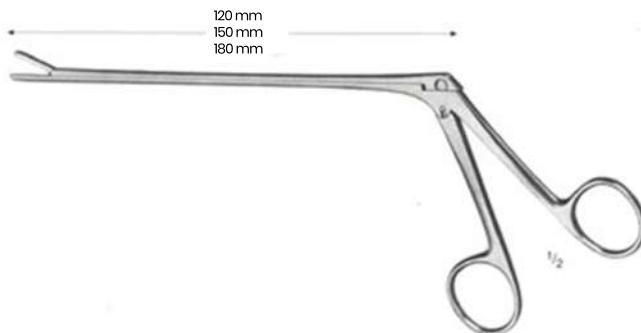

Cushing (WF-399-001 - WF-399-009) 2mm



2 x 10 mm
WF-399-001 - 12.0 cm
WF-399-002 - 15.0 cm
WF-399-003 - 18.0 cm



2 x 10 mm / 45°
WF-399-004 - 12.0 cm
WF-399-005 - 15.0 cm
WF-399-006 - 18.0 cm

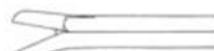

2 x 10 mm / 45°
WF-399-007 - 12.0 cm
WF-399-008 - 15.0 cm
WF-399-009 - 18.0 cm

Love-Gruenwald (WF-399-010 - WF-399-018) 3mm



3 x 10 mm
WF-399-010 - 12.0 cm
WF-399-011 - 15.0 cm
WF-399-012 - 18.0 cm



3 x 10 mm / 45°
WF-399-013 - 12.0 cm
WF-399-014 - 15.0 cm
WF-399-015 - 18.0 cm



3 x 10 mm / 45°
WF-399-016 - 12.0 cm
WF-399-017 - 15.0 cm
WF-399-018 - 18.0 cm

Spurling (WF-399-019 - WF-399-027) 4mm



4 x 10 mm
WF-399-019 - 12.0 cm
WF-399-020 - 15.0 cm
WF-399-021 - 18.0 cm



4 x 10 mm / 45°
WF-399-022 - 12.0 cm
WF-399-023 - 15.0 cm
WF-399-024 - 18.0 cm

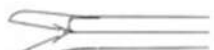

4 x 10 mm / 45°
WF-399-025 - 12.0 cm
WF-399-026 - 15.0 cm
WF-399-027 - 18.0 cm

Neurosurgery Laminectomy Rongeurs

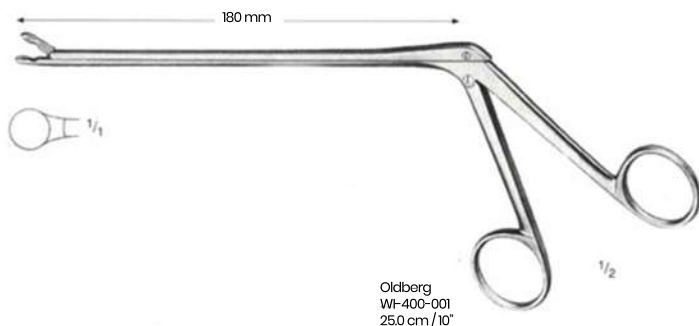

Oldberg
WF-400-001
25.0 cm / 10"

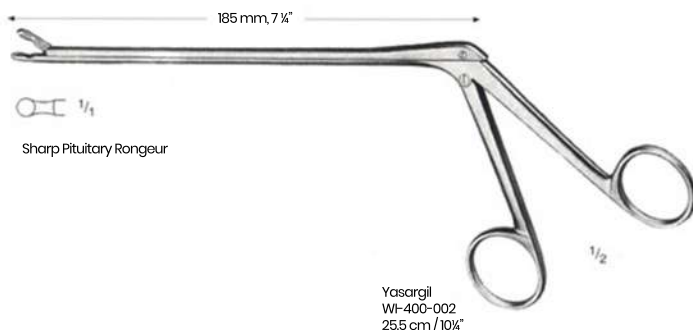

Sharp Pituitary Rongeur

Yasargil
WF-400-002
25.5 cm / 10 1/4"

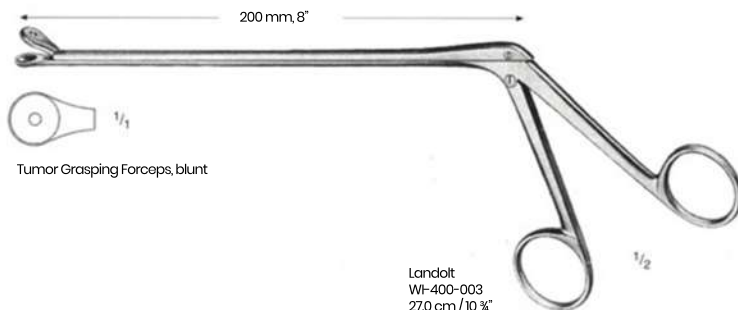

Tumor Grasping Forceps, blunt

Landolt
WF-400-003
27.0 cm / 10 3/4"

Neurosurgery Laminectomy Rongeurs



Kerrison Rongeurs

18.0 cm / 7" shaft
WI-401-001-WI-401-010

90° Up-bite 90° Down-bite

| | | |
|------------|------------|----------|
| WI-401-001 | WI-401-006 | 2mm bite |
| WI-401-002 | WI-401-007 | 3mm bite |
| WI-401-003 | WI-401-008 | 4mm bite |
| WI-401-004 | WI-401-009 | 5mm bite |
| WI-401-005 | WI-401-010 | 6mm bite |

Kerrison Rongeurs

20.0 cm / 8" shaft
WI-401-011-WI-401-020

90° Up-bite 90° Down-bite

| | | |
|------------|------------|----------|
| WI-401-011 | WI-401-016 | 2mm bite |
| WI-401-012 | WI-401-017 | 3mm bite |
| WI-401-013 | WI-401-018 | 4mm bite |
| WI-401-014 | WI-401-019 | 5mm bite |
| WI-401-015 | WI-401-020 | 6mm bite |

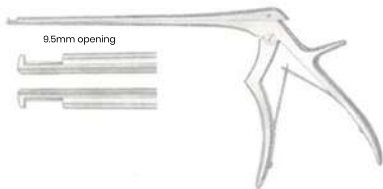

Kerrison Rongeurs

18.0 cm / 8" shaft, 40° forward-angle
WI-401-021-WI-401-025

| | | | |
|------------|----------|------------|----------|
| WI-401-021 | 2mm bite | WI-401-024 | 5mm bite |
| WI-401-022 | 3mm bite | WI-401-025 | 6mm bite |
| WI-401-023 | 4mm bite | | |

Kerrison Rongeurs

20.0 cm / 8" shaft, 40° forward-angle
WI-401-026-WI-401-030

| | | | |
|------------|----------|------------|----------|
| WI-401-026 | 2mm bite | WI-401-029 | 5mm bite |
| WI-401-027 | 3mm bite | WI-401-030 | 6mm bite |
| WI-401-028 | 4mm bite | | |

Kerrison Rongeurs

23.0 cm / 8" shaft, 40° forward-angle
WI-401-031-WI-401-035

| | | | |
|------------|----------|------------|----------|
| WI-401-031 | 2mm bite | WI-401-034 | 5mm bite |
| WI-401-032 | 3mm bite | WI-401-035 | 6mm bite |
| WI-401-033 | 4mm bite | | |

Kerrison Rongeurs

25.0 cm / 10" shaft, 40° forward-angle
WI-401-036-WI-401-040

| | | | |
|------------|----------|------------|----------|
| WI-401-036 | 2mm bite | WI-401-039 | 5mm bite |
| WI-401-037 | 3mm bite | WI-401-040 | 6mm bite |
| WI-401-038 | 4mm bite | | |

Kerrison Rongeurs

28.0 cm / 11" shaft, 40° forward-angle
WI-401-041-WI-401-045

| | | | |
|------------|----------|------------|----------|
| WI-401-041 | 2mm bite | WI-401-044 | 5mm bite |
| WI-401-042 | 3mm bite | WI-401-045 | 6mm bite |
| WI-401-043 | 4mm bite | | |



Neurosurgery Laminectomy Rongeurs



Love-Kerrison Rongeurs 41° forward-angle WI-402-001-WI-402-010

| 18.0 cm / 7" shaft | 20.0 cm / 8" shaft | |
|--------------------|--------------------|----------|
| WI-402-001 | WI-402-006 | 2mm bite |
| WI-402-002 | WI-402-007 | 3mm bite |
| WI-402-003 | WI-402-008 | 4mm bite |
| WI-402-004 | WI-402-009 | 5mm bite |
| WI-402-005 | WI-402-010 | 6mm bite |

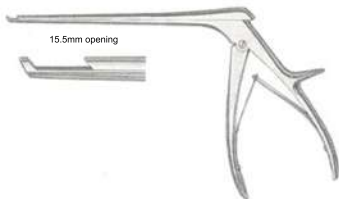

Love-Kerrison Rongeurs improved handle, 90° up-bite WI-402-011-WI-402-020

| 18.0 cm / 7" shaft | 20.0 cm / 8" shaft | |
|--------------------|--------------------|----------|
| WI-402-011 | WI-402-016 | 2mm bite |
| WI-402-012 | WI-402-017 | 3mm bite |
| WI-402-013 | WI-402-018 | 4mm bite |
| WI-402-014 | WI-402-019 | 5mm bite |
| WI-402-015 | WI-402-020 | 6mm bite |

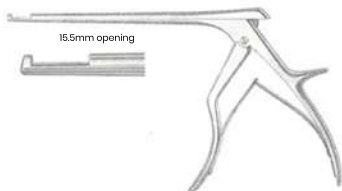

Love-Kerrison Rongeurs improved handle, 40° forward-angle WI-402-021-WI-402-040

| 18.0 cm / 7" shaft | 20.0 cm / 8" shaft | 23.0 cm / 9" shaft | 28.0 cm / 11" shaft | |
|--------------------|--------------------|--------------------|---------------------|----------|
| WI-402-021 | WI-402-026 | WI-402-031 | WI-402-036 | 2mm bite |
| WI-402-022 | WI-402-027 | WI-402-032 | WI-402-037 | 3mm bite |
| WI-402-023 | WI-402-028 | WI-402-033 | WI-402-038 | 4mm bite |
| WI-402-024 | WI-402-029 | WI-402-034 | WI-402-039 | 5mm bite |
| WI-402-025 | WI-402-030 | WI-402-035 | WI-402-040 | 6mm bite |

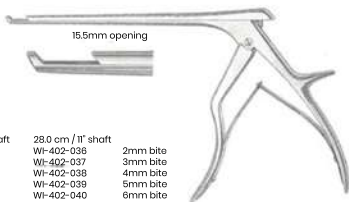

Neurosurgery Laminectomy Rongeurs

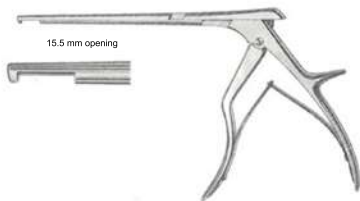

Love-Kerrison Rongeur
improved handle, 20.0 cm / 8" shaft
90° down-bite
WI-403-001-WI-403-005

| | |
|------------|----------|
| WI-403-001 | 2mm bite |
| WI-403-002 | 3mm bite |
| WI-403-003 | 4mm bite |
| WI-403-004 | 5mm bite |
| WI-403-005 | 6mm bite |

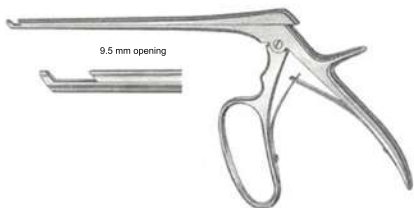

Laminectomy Rongeurs
40° forward angle
WI-403-006-WI-403-009

| | | |
|-----------------------|--------------------|----------|
| 17.5cm / 6 7/8" shaft | 20.0 cm / 8" shaft | |
| WI-403-006 | WI-403-006 | 3mm bite |
| WI-403-007 | WI-403-009 | 5mm bite |

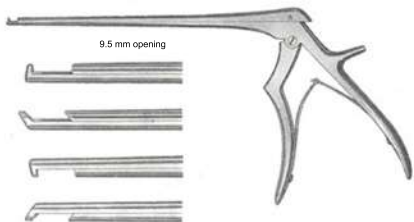

Sella Punches
18.0 cm / 7" shaft 2mm bite
WI-403-010-WI-403-013

| | |
|------------|---------------|
| WI-403-010 | 90° up-bite |
| WI-403-011 | 40° up-bite |
| WI-403-012 | 90° down-bite |
| WI-403-013 | 40° down-bite |

Neurosurgery Laminectomy Rongeurs



Schiesinger Rongeur
13.0 cm / 5" shaft, serrated jaws, straight
WI-404-001-WI-404-004

WI-404-001 2 x 10mm bite
WI-404-002 3 x 10mm bite
WI-404-003 4 x 10mm bite
WI-404-004 3 x 10mm bite, up up angled



Special Model
13.0 cm / 5" shaft, serrated jaws
6 x 10mm bite
WI-404-001-WI-404-004

WI-404-005 Straight
WI-404-006 Up-angled
WI-404-007 Down-angled

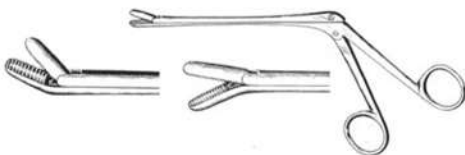

wildie Rongeurs
fenestrated jaws, straight
WI-404-008-WI-404-016

| | | | |
|------------------------|--------------------|--------------------|----------|
| 14.0 cm / 5 1/2" shaft | 18.0 cm / 7" shaft | 23.0 cm / 9" shaft | |
| WI-404-008 | WI-404-011 | WI-404-014 | 4mm bite |
| WI-404-009 | WI-404-012 | WI-404-015 | 5mm bite |
| WI-404-010 | WI-404-013 | WI-404-016 | 6mm bite |



wildie Rongeurs
fenestrated jaws, up-angled
10.8 cm / 4 1/4" shaft, 5mm bite
WI-404-017



Neurosurgery Intervertebral Disc Rongeurs



Jackson Rongeur
18.0 cm / 7" shaft, fenestrated jaws

WI-405-001 4 x 8mm bite, 70° up-angled



Peapod (Bead-Type) Forceps
14.0 cm / 5 1/2" shaft, 45° up angled
WI-405-002-WI-405-004

WI-405-002 2.3 x 7mm bite
WI-405-003 2.7 x 7mm bite
WI-405-004 3.2 x 7mm bite



Takahashi Rongeur
13.0 cm / 5" shaft, 4 x 10mm bite
WI-405-005

Neurosurgery Intervertebral Disc Rongeurs



Ferris-Smith Cup Jaw Rongeurs
18.0 cm / 7" shaft, straight

| | |
|------------|---------------|
| WI-406-006 | 2 x 10mm bite |
| WI-406-007 | 3x 10mm bite |
| WI-406-008 | 4 x 10mm bite |
| WI-406-009 | 4 x 8mm bite |
| WI-406-010 | 6 x 10mm bite |
| WI-406-011 | 6 x 12mm bite |

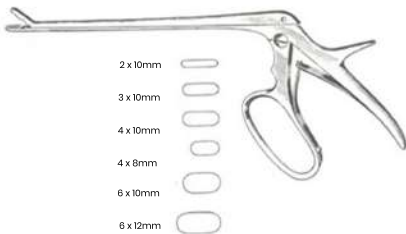

2 x 10mm



Ferris-Smith Cup Jaw Rongeurs
18.0 cm / 7" shaft, up-angled

| | |
|------------|---------------|
| WI-406-012 | 2 x 10mm bite |
| WI-406-013 | 3x 10mm bite |
| WI-406-014 | 4 x 10mm bite |
| WI-406-015 | 6 x 10mm bite |



Ferris-Smith Cup Jaw Rongeurs
18.0 cm / 7" shaft, up-angled

| | |
|------------|---------------|
| WI-406-016 | 2 x 10mm bite |
| WI-406-017 | 3x 10mm bite |
| WI-406-018 | 4 x 10mm bite |

Stookey Carnial Rongeur
19.0 cm / 7 1/2" 3mm bite
WI-4060-019



Otology Micro Ear Forceps

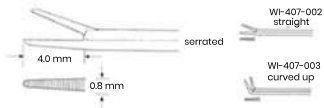
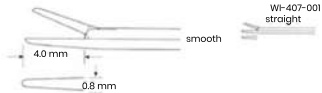

WI-407-003
curved up

WI-407-004
right

WI-407-005
left



WI-407-001-WI-407-005

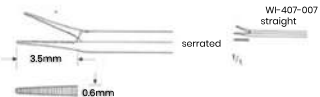
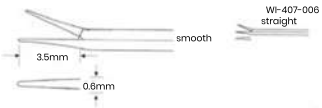

Mini McQueen Alligator
WI-407-006-WI-407-007

Otology Micro Ear Forceps



WI-408-008

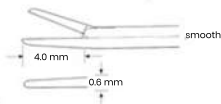

WI-408-008
4.0 x 0.6 mm
straight

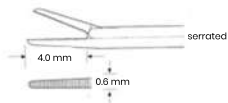

WI-408-009
4.0 x 0.6 mm
straight



WI-408-009-WI-408-012

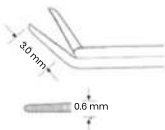

WI-408-010
3.0 x 0.6 mm
curved up



WI-408-011^l
3.0 x 0.6 mm
right



WI-408-012
3.0 x 0.6 mm
left

Otology

Micro Cup-Shaped-Forceps



WI-409-013-WI-409-016

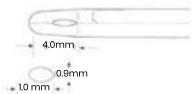

WI-409-013
straight

WI-409-014
curved up

WI-409-015
right

left

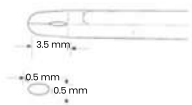

WI-409-017
straight

WI-409-018
curved up

WI-409-019
right

WI-409-020
left



WI-409-017-WI-409-020

Otology

Micro Ear Scissors

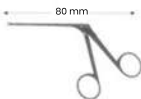

Bellucci
WI-410-021-WI-410-024

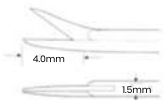

WI-410-021
straight

WI-410-022
curved up

WI-410-023
right

WI-410-024
left



Wullstein
WI-410-025-WI-410-028

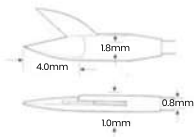

WI-410-025
straight

WI-410-026
curved up

WI-410-027
right

WI-410-028
left



Greven
WI-411-029

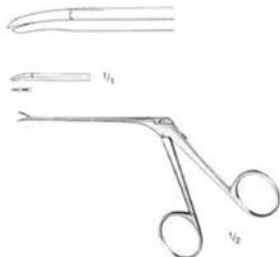

Schuknecht
WI-411-030

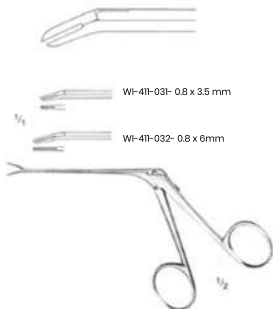

McGee
WI-411-032- WI-411-032

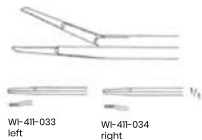

Juers
WI-411-033- WI-411-034

WI-411-031- 0.8 x 3.5 mm

WI-411-032- 0.8 x 6mm

WI-411-033
left

WI-411-034
right

Otology

Introduction Instrument, Crura and Malleus Nippers

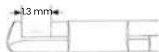

WI-412-035

WI-412-036



House-Dieter
WI-412-035-WI-412-036

WI-412-037 left

WI-412-038 right



House-Dieter
WI-412-037-WI-412-038



Fuuler
WI-412-039

*Instruments for introducing teflon pistons

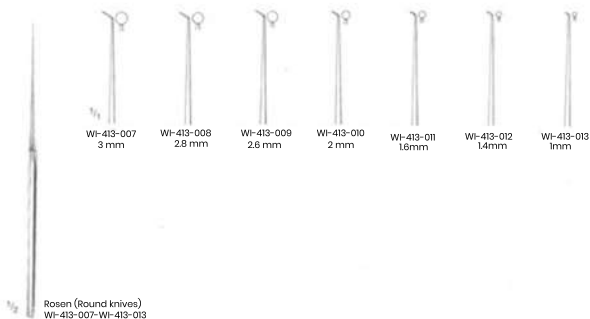

Otology Needles, Picks and Hooks, Straight Shaft



Barbara
WI-414-001



WI-414-002



WI-414-003



Rosen
WI-414-004



Barbara
WI-414-005-WI-414-023



WI-414-005-0.3 mm
WI-414-006-06 mm
WI-414-007-10 mm



WI-414-008- 0.3 mm
WI-414-009- 06 mm
WI-414-010-1.0 mm
WI-414-011- 1.2 mm
WI-414-012- 1.5 mm
WI-414-013- 2.0 mm
WI-414-014-2.5 mm



WI-414-015- 0.3 mm
WI-414-016- 06 mm
WI-414-017-1.0 mm
WI-414-018- 1.2 mm
WI-414-019- 1.5 mm
WI-414-020- 2.0 mm
WI-414-021-2.5 mm



WI-414-022- 0.5 mm
WI-414-023- 1.0 mm



① mm Ø
=3
WI-415-001

① mm Ø
=4.0
WI-415-002

② mm Ø
=5.0
WI-415-003



Hartmann
for children

| Pieces | | Fig. |
|----------|-----|------------|
| Set of 3 | 0-2 | WI-415-004 |

① mm Ø
=4.0
WI-415-005

② mm Ø
=5.0
WI-415-006

③ mm Ø
=6.0
WI-415-007

④ mm Ø
=7.5
WI-415-008



Hartmann
for adults

| Pieces | | Fig. |
|----------|-----|------------|
| Set of 3 | 2-4 | WI-415-009 |
| Set of 4 | 1-4 | WI-415-010 |

① mm Ø
=4.0
WI-415-011

② mm Ø
=5.0
WI-415-012

③ mm Ø
=6.0
WI-415-013

④ mm Ø
=7.5
WI-415-014



Toynbee
for adults

| Pieces | | Fig. |
|----------|-----|------------|
| Set of 3 | 2-4 | WI-415-015 |
| Set of 4 | 1-4 | WI-415-016 |

① mm Ø
=4.5
WI-415-017

② mm Ø
=5.5
WI-415-018

③ mm Ø
=6.5
WI-415-019

④ mm Ø
=7.5
WI-415-020



Gruber
for adults

| Pieces | | Fig. |
|----------|-----|------------|
| Set of 3 | 2-4 | WI-415-021 |

① mm Ø
=4.5
WI-415-022

② mm Ø
=5.5
WI-415-023

③ mm Ø
=6.5
WI-415-024

④ mm Ø
=7.5
WI-415-025



Gruber
for adults

| Pieces | | Fig. |
|----------|-----|------------|
| Set of 4 | 1-4 | WI-415-026 |

① 5.5 x
8.5 mm
WI-415-027

② 5.5 x
7.5 mm
WI-415-028

③ 5.5 x
8.5 mm
WI-415-029

④ 5.5 x
8.5 mm
WI-415-030



Zollner
for adults

| Pieces | | Fig. |
|----------|--|------------|
| Set of 6 | | WI-415-033 |

Aluminium black

⑤ 5.5 x
10.5 mm
WI-415-031

⑥

WI-415-032

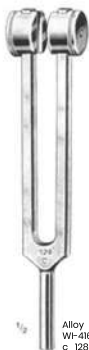

Alloy
WI-416-001
c° 128



Alloy
WI-416-002
c° 256



Alloy
WI-416-003
c° 512



Alloy
WI-416-004
c° 1024



Alloy
WI-416-005
c° 1248



Hartmann
WI-416-006
c° 128



Hartmann
WI-416-007
c° 256



Hartmann
WI-416-008
c° 512



Hartmann
WI-416-009
c° 1024



Hartmann
WI-416-010
c° 2048



Hartmann
WI-416-011
c° 4096

Otology

Ear Polypus Snares, Ear Dressing Forceps



Krause
WI-417-001



Krause-Voss
WI-417-002



Troeltsch (Wildle)
WI-417-003
11.0 cm / 4 1/4"



Troeltsch (Wildle)
WI-417-004
12.0 cm / 4 3/4"



Troeltsch (Wildle)
WI-417-005
13.0 cm / 5"



Lucas
WI-417-006
14.0 cm / 5 1/2"



Jönson
WI-417-007 - 16.0 cm / 6 1/4"
WI-417-008 - 20.0 cm / 8"

Otology

Ear Polypus Forceps, Foreign Body Levers



Litauer
WI-418-001
12.0 cm / 4 $\frac{3}{4}$ "



Hartmann
WI-418-002
12.0 cm / 4 $\frac{3}{4}$ "
fine pattern



Hartmann
WI-418-003
14.0 cm / 5 $\frac{1}{2}$ "
standard pattern



Buck
WI-418-004



Quire
WI-418-005

Otology

Ear Polypus Forceps



Hartmann-Wullstein
WI-419-001
8.5 cm / 3 1/2"

○ 1 mm



Hartmann-Wullstein
WI-419-002
8.5 cm / 3 1/2"



Hartmann
WI-419-003- 8.5 cm / 3 1/2"
WI-419-004- 8.5 cm / 5 1/2"
WI-419-005 - 8.5 cm / 6 1/2"



Hartmann
WI-419-006- 8.5 cm / 3 1/2"
WI-419-007- 14.0 cm / 5 1/2"



Hartmann-Noyes
WI-419-008- 9.0 cm / 3 1/2"



Hartmann-Noyes
WI-419-009- 9.0 cm / 3 1/2"



Hartmann-Weingartner
WI-419-010- 8.5 cm / 3 1/2"



Hartmann
WI-419-011- 8.5 cm / 3 1/2"

○ 2 mm

○ 2.5 mm

○ 3 mm



Hartmann
WI-419-012- 2 mm Ø
WI-419-013- 2.5 mm Ø
WI-419-014 - 3 mm Ø



Hartmann
WI-419-015
8.5 cm / 3 1/2"



Struempel
WI-419-016
8.5 cm / 3 1/2"



Hartmann
WI-419-017
8.5 cm / 3 1/2"



WI-419-001-WI-419-019



Hartmann
WI-419-018
8.5 cm / 3 1/2"

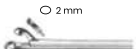

○ 2 mm

Hartmann-Hoffmann
WI-419-019
8.5 cm / 3 1/2"



Citelli
WI-420-001



Beyer
WI-420-002

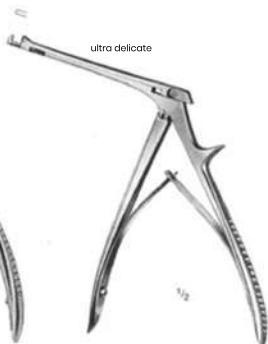

Beyer
WI-420-003



Langenbeck
WI-421-001
13.3 cm / 5 1/8"



Shapleigh
WI-421-002-WI-421-005
13.3 cm / 5 1/8"



WI-421-002



WI-421-003



WI-421-004



WI-421-005



Buck
WI-421-006-WI-421-019
16.5 cm / 6 1/2"



blunt

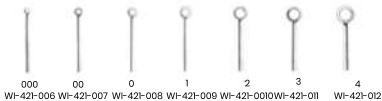

000 WI-421-006 00 WI-421-007 0 WI-421-008 1 WI-421-009 2 WI-421-010 3 WI-421-011 4 WI-421-012



sharp

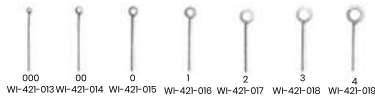

000 WI-421-013 00 WI-421-014 0 WI-421-015 1 WI-421-016 2 WI-421-017 3 WI-421-018 4 WI-421-019

Otology Cruettes and Spoons

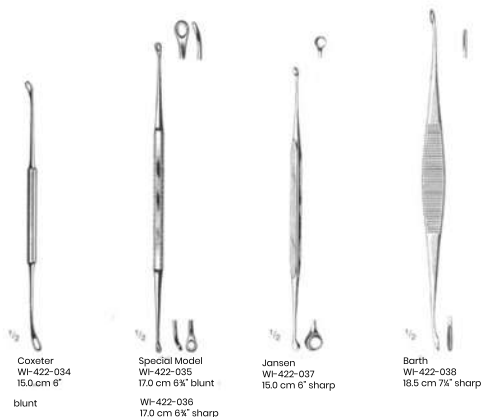
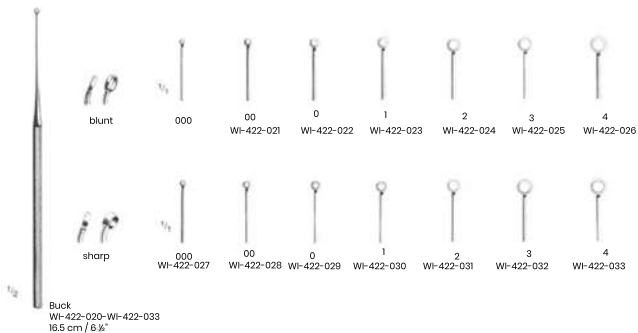

Otology

Loops, Foreign Body Instruments, Hooks



Gross
WI-423-001
12.0 cm / 4 3/4"
blunt



WI-423-002-WI-423-003
16.0 cm / 6 1/4"

WI-423-002

WI-423-003



Billeau
WI-423-004-WI-423-006
16.4 cm / 6 1/2"

WI-423-004

WI-423-005

WI-423-006



Moldenhauer
WI-423-007
16.5 cm / 6 1/2"



Zaufal
WI-423-008
16.0 cm / 6 1/4"



Hartman
WI-423-009
16.0 cm / 6 1/4"

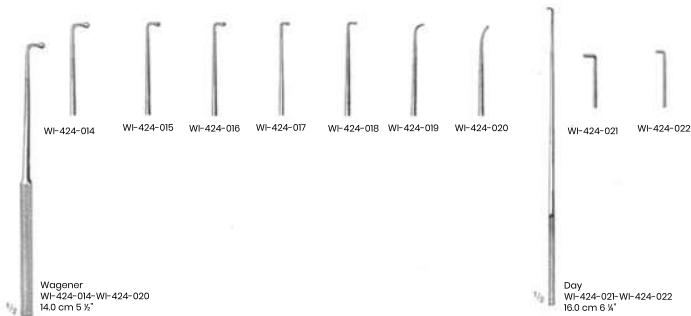
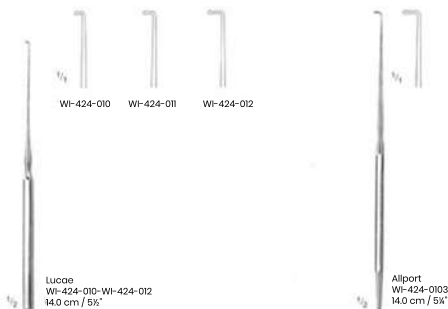

Otology Elevators, Raspatories, Curettes ETC.

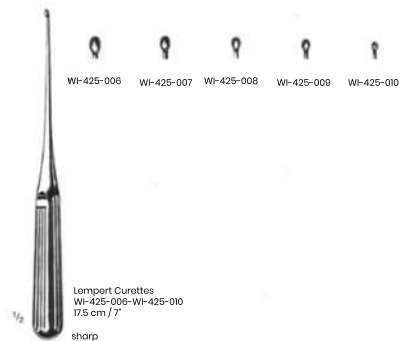
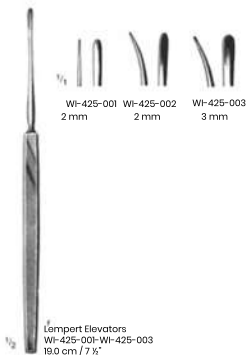



Heister
WI-426-001
13.0 cm / 5"



Molt
WI-426-002
11.0 cm / 4 1/2"



Molt
WI-426-003
14.0 cm / 5 1/2"



Denhart
WI-426-004
12.0 cm / 4 3/4"



Roser-Konig
WI-426-005-16.0 cm / 6 1/4"
WI-426-006-19.0 cm / 7 1/2"

Oral and Facial Surgery Mouth Gags



Whitehead
WI-427-007-11.0 cm / 4 1/4"
WI-427-008-13.0 cm / 5"
WI-427-009-15.0 cm / 6"

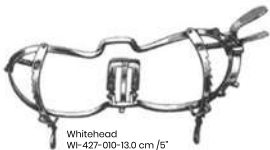

Whitehead
WI-427-010-13.0 cm / 5"



Jennings
WI-427-011- 9.0 cm / 3 1/2"
WI-427-012- 1.0 cm / 4 1/2"
WI-427-013 - 13.0 cm / 5"
WI-427-014 - 15.0 cm / 6"



Seemann-Seiffert
(Self-retaining)
WI-427-015- 9.0 cm / 3 1/2"
WI-427-016- 11 cm / 4 1/2"
WI-427-017 - 13.0 cm / 5"
WI-427-018 - 15.0 cm / 6"

Tongue Depressors



Kilner- Doughty
Complete with frame
WI-427-019

Gag
WI-427-020



WI-427-021
Fig.1



WI-427-022
Fig.2



WI-427-023
Fig.3

Oral and Facial Surgery Mouth Gags



WI-428-024



27 x 105 mm WI-428-025



25 x 90 mm WI-428-026



25 x 75 mm WI-428-027



22 x 80 mm WI-428-028



20 x 25 mm WI-428-029

Davis-Byle
WI-428-030
complete with 6 blades



WI-428-031



27 x 95 mm WI-428-032



22 x 85 mm WI-428-033



22 x 70 mm WI-428-034

MCIVOR
WI-428-035
complete with 3 blades

Oral and Facial Surgery

Mouth Gags and Tongue Holding Forceps

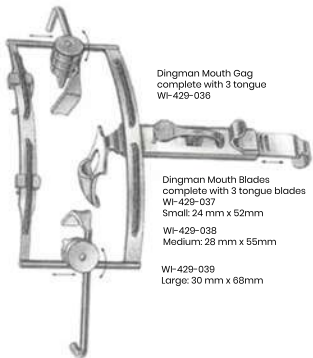

Dingman Mouth Gag
complete with 3 tongue
WI-429-036

Dingman Mouth Blades
complete with 3 tongue blades

WI-429-037
Small: 24 mm x 52mm
WI-429-038
Medium: 28 mm x 55mm

WI-429-039
Large: 30 mm x 68mm



Collin
WI-429-040
17.0 cm / 6 3/4"



Guy
WI-429-041
19.0 cm / 7 1/2"



Young
WI-429-042
17.0 cm / 6 3/4"



WI-429-043
pair

Oral and Facial Surgery Tongue Depressors



Moritz-Schmidt
WI-430-001
19.0 cm / 7½"



Hartmann
WI-430-002
15.0 cm / 6"



Tobold
WI-430-003
14.0 cm / 5½"



Tobold
WI-430-004
14.0 cm / 5½"



Andrew
WI-430-005
11.0 cm / 4 ½"



WI-430-006
14.0 cm / 5½"



WI-430-007
15.0 cm / 6"

Oral and Facial Surgery Tongue Depressors

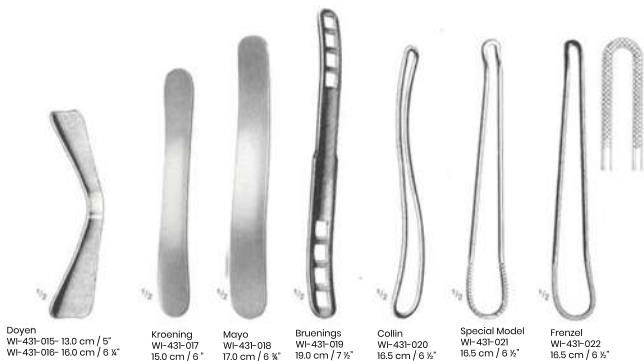
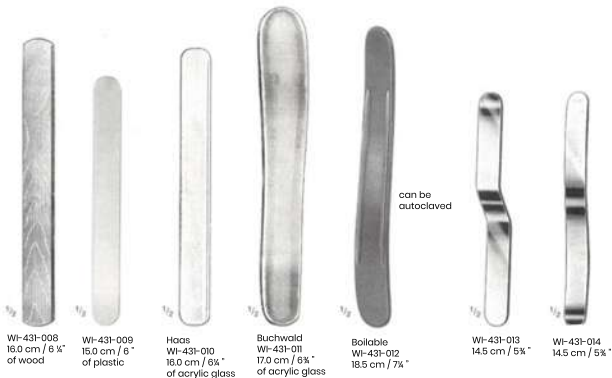

Oral and Facial Surgery Soft Tissue Retractors



Obwegeser
(Kocher-Langenbeck)
WI-432-001-WI-432-006
21.5 cm / 8 1/2"



Obwegeser
WI-432-007-WI-432-009
22.0 cm / 8 3/4"

Oral and Facial Surgery Chin Retractors and Chanelled Retractors, Remus Retractors



Obwegeser
WI-433-010
16.0 cm / 6 1/4"



Obwegeser
WI-433-011 - 8mm
WI-433-012 - 10mm
16.0 cm / 6 1/4"

10 x 42 mm



11 x 70 mm



Obwegeser
WI-433-013
22.0 cm / 8 3/4"



Obwegeser
WI-433-014
22.0 cm / 8 3/4"



Obwegeser
WI-434-001-WI-434-004
17.5 cm / 7"



8 mm
WI-434-001



7 mm
WI-434-002



9 mm
WI-434-003



11 mm
WI-434-004



Obwegeser
WI-434-005-WI-434-007
20.0 cm / 8"



5 mm
WI-434-005



7 mm
WI-434-006



9 mm
WI-434-007

Oral and Facial Surgery Periosteal Elevators, Osteotomes

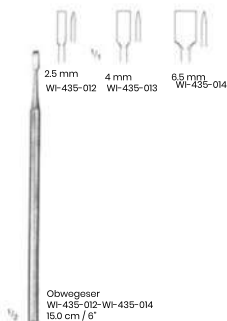
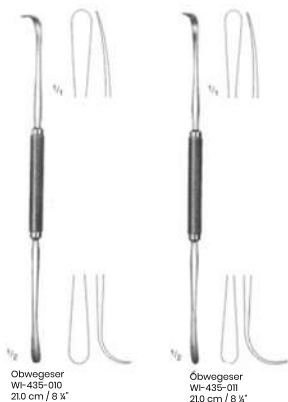
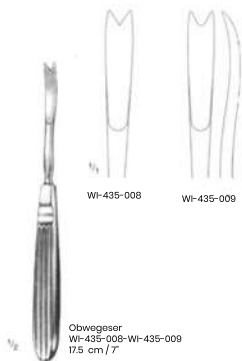



Obwegeser
WI-435-018-18.0 cm / 7"
WI-435-019-28.0 cm / 11"



Obwegeser
WI-435-020
13.0 cm / 5"



Obwegeser
WI-435-021
23.0 cm / 9"



WI-437-001
WI-437-004



WI-437-002
WI-437-005

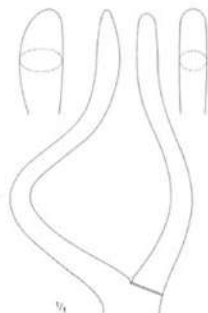

WI-437-003
WI-437-006



Rowe
WI-437-001-WI-437-003



Rowe
WI-437-004-WI-437-006



$\frac{1}{2}$
Fisher
WI-438-001
23.0 cm / 9"



$\frac{1}{2}$
Abraham
WI-438-002
21.0 cm / 8 $\frac{1}{4}$ "



$\frac{1}{2}$
Bruenings
WI-438-003
23.0 cm / 9"

Oral and Facial Surgery
Tonsil Knives, Dissectors,
Enucleator, Retractor
ETC.



Carpenter
WI-439-004
25.0 cm / 10"



Carpenter
WI-439-005
24.0 cm / 9 1/2"



Hurd
WI-439-006
23.0 cm / 9"



Henke
WI-439-007
23.0 cm / 9"



Henke
WI-439-008
23.0 cm / 9"

Oral and Facial Surgery Tonsil Seizing Forceps

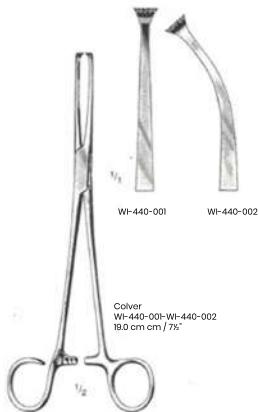

Colver
WI-440-001-WI-440-002
19.0 cm cm / 7½"



Ballenger
WI-440-003
21.5 cm / 8½"



White
WI-440-001-18.0 cm / 7"
WI-440-005-23.0 cm / 9"



Biohmke
WI-440-006
20.0 cm cm / 8"

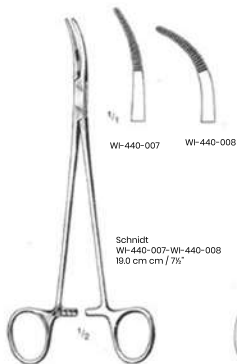

Schnidt
WI-440-007-WI-440-008
19.0 cm cm / 7½"

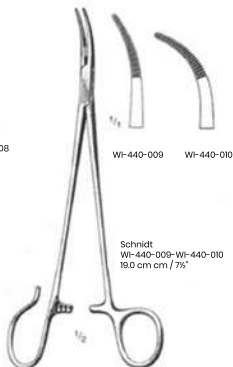

Schnidt
WI-440-009-WI-440-010
19.0 cm cm / 7½"

Oral and Facial Surgery Tonsil Snares



WI-441-001-40mm
WI-441-002-50mm



WI-441-003
0.3 mm Ø"



Eves
WI-441-004
28.0 cm / 11"



Eves
WI-441-005
28.0 cm / 11"



Bruenings
WI-441-006
28.0 cm / 11"

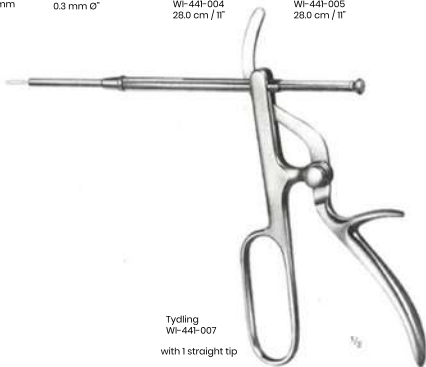

Tydling
WI-441-007
with 1 straight tip

Oral and Facial Surgery Tonsil Snares

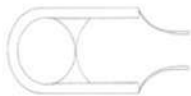

Fig.1

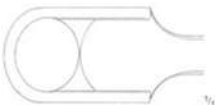

Fig. 2

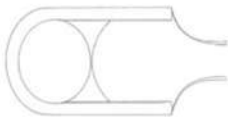
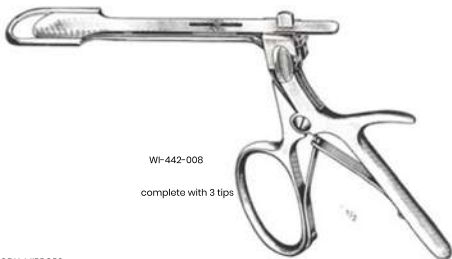

Fig. 3



WI-442-008

complete with 3 tips

LARYNGEAL MIRRORS



| | | | | |
|-------------------|---------------|---|----------------|-------------------|
| WI-442-009 | Fig. 00 | = | 8 mm Ø | WI-442-021 |
| WI-442-010 | Fig. 0 | = | 10 mm Ø | WI-442-022 |
| WI-442-011 | Fig. 1 | = | 12mm Ø | WI-442-023 |
| WI-442-012 | Fig. 2 | = | 14mm Ø | WI-442-024 |
| WI-442-013 | Fig. 3 | = | 16mm Ø | WI-442-025 |
| WI-442-014 | Fig. 4 | = | 18 mm Ø | WI-442-026 |
| WI-442-015 | Fig. 5 | = | 20 mm Ø | WI-442-027 |
| WI-442-016 | Fig. 6 | = | 22mm Ø | WI-442-028 |
| WI-442-017 | Fig. 7 | = | 24 mm Ø | WI-442-029 |
| WI-442-018 | Fig. 8 | = | 26 mm Ø | WI-442-030 |
| WI-442-019 | Fig. 9 | = | 28 mm Ø | WI-442-031 |
| WI-442-020 | Fig. 10 | = | 30mm Ø | WI-442-031 |

Oral and Facial Surgery Universal Handlers and Interchangeable Tubes, Broncho- Esophagoscopy Forceps

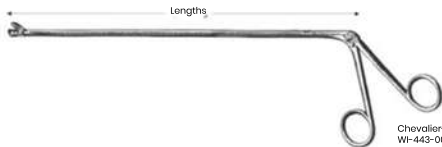

Chevalier-Jackson
WI-443-003-WI443-028

Upper Jaws Moveable

| cm | in | WI-443-001 | WI-443-005 | WI-443-009 | WI-443-013 | WI-443-017 | WI-443-021 | WI-443-025 |
|----|----|------------|------------|------------|------------|------------|------------|------------|
| 30 | 12 | WI-443-002 | WI-443-006 | WI-443-010 | WI-443-014 | WI-443-018 | WI-443-022 | WI-443-026 |
| 40 | 16 | WI-443-003 | WI-443-007 | WI-443-011 | WI-443-015 | WI-443-019 | WI-443-023 | WI-443-027 |
| 50 | 20 | WI-443-004 | WI-443-008 | WI-443-012 | WI-443-016 | WI-443-020 | WI-443-024 | WI-443-028 |



Huber
WI-443-029



Bruenings
WI-443-030

*Universal Detachable Handles
or use with interchangeable tips and tubes



WI-443-031-WI-443-033

| Straight | Lengths | |
|------------|---------|-----|
| | cm | in. |
| WI-443-031 | 20 | 8 |
| WI-443-032 | 30 | 12 |
| WI-443-033 | 40 | 16 |



Bruenings
WI-443-034
20.0 cm / 8"

*Laryngeal Tube for above mentioned handle

Oral and Facial Surgery Cutting and Grasping Forceps Tips



Fraenkel
WI-444-001



Seiffert
WI-444-002



Fraenkel
WI-444-003



Scheinmann
WI-444-004



Scheinmann
WI-444-005

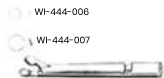

WI-444-006



WI-444-007

Bruenings
WI-444-006-WI-444-007



WI-444-008



WI-444-009

Bruenings
WI-444-008-WI-444-009



Lange
WI-444-010

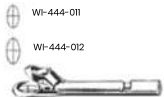

WI-444-011



WI-444-012

Krause
WI-444-011-WI-444-012



Krause
WI-444-013

WI-444-014

WI-444-015

WI-444-016

WI-444-017



Cordes
WI-444-014-WI-444-017



with drawing cut

Schumacher
WI-444-018

WI-444-019

WI-444-020



Cordes
WI-444-019-WI-444-020



Cordes
WI-444-021



Rosenberg
WI-444-022

Oral and Facial Surgery Catheter Forceps and Laryngoscopes

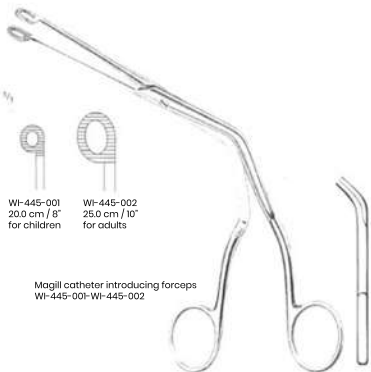

Miller
WI-445-003

* Consisting of Battery Handle (without battery)
& 4 blades

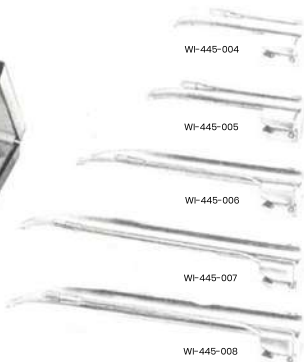



McIntosh
WI-446-009

Laryngoscope set
consisting of
battery handle (without battery)
& three blades



WI-446-010



WI-446-011



WI-446-012



WI-446-013



WI-446-014



Grasping Forceps
Straight, serrated jaws with
proximal recess, double action



WI-447-001
Ratchet, insulated shaft
5mm, 32cm



WI-447-002
Monopolar
5mm, 32cm

WI-447-003
Monopolar
5mm, 45cm



WI-447-004
ROTO-LOK, ratchet
5mm, 32cm



WI-447-005
ROTO-LOK, locking lever
5mm, 32cm

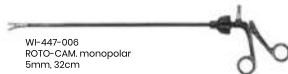

WI-447-006
ROTO-CAM, monopolar
5mm, 32cm



TC Grasping Forceps
Double action
CARB-BITE tips, 22mm long
jaws to maintain firm
grasp on delicate
on tissue, double action



WI-447-007
ROTO-CAM, ratchet
5mm, 32cm



WI-447-008
ROTO-CAM, locking lever
5mm, 32cm



Strong TC Grasping Forceps
Heavy CARB-BITE inserts
allow jaws to maintain firm
hold on tissue, double action



WI-447-009
ROTO-CAM, ratchet
5mm, 32cm



WI-447-009
ROTO-CAM, locking lever
5mm, 37cm



Grabber Forceps
Long, fenestrated jaws with interlocking wave-like serrations for strong hold, double action



Fundus Grabber Forceps
Long, beveled-edge jaws permit a large purchase on tissue and maintain a strong hold

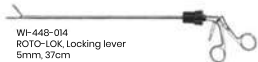

Double-Cup Grasping Forceps
Double cup design increases surface area contact which improves hold on tissue, double action

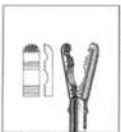
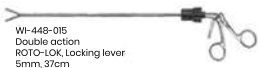

Dual-Cup Grasping Forceps
Double cup design increases surface area contact which improves hold on tissue, double action





Retraction Grasping Forceps
Long-rigid jaws with
2 x 3 blunt interdigitating
teeth for strong grasp
of heavy tissue



WI-449-019
ROTO-LOK, ratchet
5mm, 37cm



WI-449-020
ROTO-LOK, locking lever
5mm, 37cm



WI-449-021
Double action
ROTO-LOK, locking lever
5mm, 37cm



WI-449-022
Double action
ROTO-LOK, ratchet
5mm, 37cm



Atrau-Allis Grasping Forceps
Unique jaw design offers strong
atraumatic grasp,
double action



WI-449-025
ROTO-LOK, ratchet
5mm, 32cm



WI-449-023
Ratchet, insulated shaft
5mm, 32cm

WI-449-024
Ratchet, insulated shaft
5mm, 45cm



WI-449-026
ROTO-LOK, locking lever
5mm, 32cm



Atrau-Allis L.J Grasping Forceps
Unique jaw design, in
20 mm length offers
strong atraumatic grasp,
double action.

WI-449-027
ROTO-LOK, ratchet
5mm, 37cm

WI-449-028
ROTO-LOK, locking lever
5mm, 37cm



Allis Grasping Forceps
interlocking distal teeth with
fine-serrated inner jaws,
double action



WI-450-029
Ratchet, insulated shaft
5mm, 32cm



WI-450-030
ROTO-LOK Ratchet
5mm, 32cm



Retrograde Grasping Forceps
retrograde deep-serrated
teeth allow for non-sip hold
double action



WI-450-031
Ratchet
5mm, 32cm



Grasping & dissecting Forceps
Cup-shaped, toothed jaws
double action



WI-450-032
Monopolar
5mm, 32cm



Grasping & extracting Forceps
Retrograde
deep-serrated teeth



WI-450-033
Spring-loaded
10mm, 32cm

Endoscopic Instruments Grasping Forceps



Claw Forceps
2x3 interlocking teeth
for penetrating hold and
extraction of tissue



WI-45F-034
Spring-loaded,
10mm, 32cm



Claw Forceps
2x3 interlocking teeth
for penetrating hold and
extraction of tissue



WI-45F-035
Spring-loaded,
5mm, 32cm



DeBakey Forceps
Fenestrated 45mm long jaws
with DeBakey-type teeth,
double action.



WI-45F-036
Ratchet,
5mm, 32cm



DeBakey Forceps, curved
Fenestrated 55mm long jaws
with DeBakey-type teeth,
double action.



WI-45F-037
ROTO-LOK, ratchet,
10mm, 37cm

Endoscopic Instruments

Grasping Forceps



Paddle Babcock Forceps
Flat paddles with fine, straight serrations for atraumatic hold of delicate tissue, double action.



WI-452-038
ROTO-LOK, ratchet,
10mm, 37cm



Paddle Babcock Forceps
Flat paddles with fine, straight serrations for atraumatic hold of delicate tissue, double action.



WI-452-039
ROTO-LOK, ratchet,
5mm, 37cm

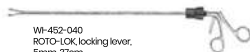

WI-452-040
ROTO-LOK, locking lever,
5mm, 37cm



Babcock Forceps
Traditional Style
Babcock
jaws designed with six rows of fine serrations for atraumatic, yet secure grasp of bowel and other delicate tissue, double action.



WI-452-041
ROTO-LOK, ratchet,
10mm, 37cm



Babcock Forceps
Rounded jaws with 2 x 3 rows of De-Bakey-type teeth for atraumatic, yet secure grasp of bowel and other delicate tissue, double action.



WI-452-042
Ratchet,
10mm, 32cm



WI-452-043
ROTO-LOK, ratchet,
10mm, 32cm

Endoscopic Instruments Grasping Forceps



Babcock Forceps
Traditional design for grasping delicate tissue, double action.



WI-453-044
Ratchet,
5mm, 32cm



WI-453-045
ROTO-LOK, ratchet,
5mm, 32cm

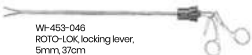

WI-453-046
ROTO-LOK, locking lever,
5mm, 37cm



Swanstrom Grasping Forceps
Unique design of 1 x 2 De-Bakey-type teeth with triangular fenestration provides an effective hold with atraumatic grasp, double action.



WI-453-047
ROTO-LOK, ratchet,
5mm, 37cm



WI-453-048
ROTO-LOK, locking lever,
5mm, 37cm



Duval Grasping Forceps
Triangular jaws with deep-serrated surfaces for non-slip, firm grasp of tissue, double action.



WI-453-049
Ratchet,
10mm, 32cm



WI-453-050
ROTO-LOK, ratchet,
10mm, 32cm

Endoscopic Instruments

Grasping Forceps



Russian Grasping Forceps
40mm long jaws with
heavy serrations for effective
tissue grasp, double action.



WI-454-051
Ratchet
10mm, 32cm



Foerster Sponge Forceps
45mm jaws firmly hold
tissue, double action.



Hunter's Clamp
Right-angle shaft with
Abrau-Allis teeth for secure
grasp and manipulation of
tissue around structures,
e.g. stomach esophagus in
fundoplication, double action.



WI-454-053
Ratchet
5mm, 32cm



Hunter's Bowel Grasper
Foerstrated, 20mm jaws for
atraumatic manipulation of
delicate tissue, e.g. bowel,
stomach, double action.



WI-454-054
ROTO-LOCK
5mm, 32cm

Endoscopic Instruments

Grasping Forceps



Stone Extractor
To facilitate stone removal once neck of gallbladder has been externalized.

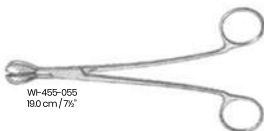

WI-455-055
18.0 cm / 7 1/8"



Strong Forceps
Fenestrated, serrated, oval-shaped jaws that converge at distal end to prevent slippage, double action.

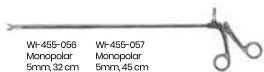

WI-455-056
Monopolar
5mm, 32 cm

WI-455-057
Monopolar
5mm, 45 cm



Strong Atraumatic Grasping Forceps
Fenestrated, serrated, curved jaws with split-steel construction, for fixation of ovary or manipulation of pelvic tissues.



WI-455-058
Spring handle
5mm, 32cm

WI-455-059
Spring handle
5mm, 45cm

Endoscopic Instruments Dessecting Forceps



Micro Dessecting Forceps
Delicate, fenestrated, serrated jaws for gentle blunt dissection, double action.



WI-456-001
Monopolar
5mm, 32cm

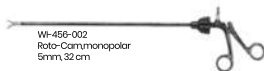

WI-456-002
Roto-Cam monopolar
5mm, 32cm



Needle, Nose Forceps
Slender, tapered and fine-serrated jaws



WI-456-003
Monopolar
5mm, 32cm



Tapered Dessecting Forceps
Tips of serrated, tapered jaws meet at fine point to allow delicate, yet firm grasp and dissection of thin adventitial tissue, double action.



WI-456-004
Monopolar
5mm, 32cm



WI-456-005
Roto-Cam monopolar
5mm, 32cm



Micro Grasping Forceps
3mm small, tapered areas for dissection of small structures.



WI-456-006
Monopolar
5mm, 32cm

Endoscopic Instruments Dessecting Forceps



Bullet-Nose Dissecting Forceps
Bullet-shaped, tapered
serrated jaws for dissection,
double action.



WF-457-007
ROTO-CAM, monopolar
5mm, 32 mm



Tapered Maryland Dissector
Curved, finely-tapered,
serrated jaws with
wide spread, double action

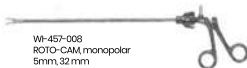

WF-457-008
ROTO-CAM, monopolar
5mm, 32 mm



Maryland Dissectors
Curved, tapered, serrated
jaws with wide spread,
double action



WF-457-009
Monopolar
5mm, 32 mm

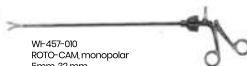

WF-457-010
ROTO-CAM, monopolar
5mm, 32 mm



Maryland Dissectors
Slender, full-curved, long
serrated jaws with wide
spread, double action



WF-457-011
ROTO-CAM, monopolar
10mm, 32 mm

Endoscopic Instruments Dessecting Forceps and Hooks



Mixer Dessecting Forceps
Slender, full-curved, long,
serrated jaws with wide
spread, double action



WI-458-012
10 mm, 32 cm



Mixer Spreader-Dissectors
Jaw design offers a true right-angle
for dissection around delicate
structures; double action.
The distinctive ergonomic handle
minimizes hand fatigue while
allowing the surgeon fine control
for precise dissection.



WI-458-013
ROTO-CAM, monopolar
10 mm, 28 cm



WI-458-014
ROTO-CAM, monopolar
right-handle, 10 mm, 32 cm



WI-458-015
10 mm, 28 cm



Mixer Spreader-Dissectors
Jaw design offers a true right-angle
for dissection around delicate
structures; double action.
The distinctive ergonomic handle
minimizes hand fatigue while
allowing the surgeon fine control
for precise dissection.

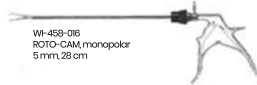

WI-458-016
ROTO-CAM, monopolar
5 mm, 28 cm



WI-458-017
ROTO-CAM, monopolar,
ring-handle, 5 mm, 32 cm



Appel® Dissecting Hook
Right-angle tip allows rapid
blunt dissection and isolation
of structures.



WI-458-018
10 mm, 40 cm

Endoscopic Instruments

Scissors



Supercut Scissors
Razor-sharp upper blade with finely-serrated lower blade allows clean, precise cut without tissue slippage

WI-459-001
5 mm, 32 cm

WI-459-002
5 mm, 45 cm



Supercyt Endo Scissors
Electrosurgical instrument with curved, SUPERCUT blades and precise cutting action offers mechanical cutting, electrosurgical cutting, blunt **dissection**, **electrosurgical coagulation** - all in one reusable, cost-effective instrument; double action

WI-459-003
Monopolar
5mm, 32 cm

WI-459-004
Monopolar
5mm, 45 cm

WI-459-005
ROTO-CAM, monopolar
5mm, 32cm

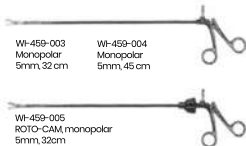

Hook Scissors
Blades designed to lift, isolate and transect tissue

WI-459-006
Monopolar
5mm, 32cm

WI-459-007
Monopolar
5mm, 45cm

WI-459-008
Non-insulated
5mm, 32cm

WI-459-009
ROTO-CAM, monopolar
5mm, 32cm



Micro Scissors
Fine, delicate, 3 mm blades for small incision

WI-459-010
Curved Left
5mm, 32cm

WI-459-011
Straight
5mm, 32 cm

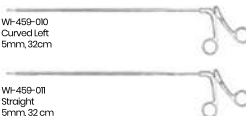

Mayo Operating Scissors
Large, sturdy blades for incising heavy tissue

WI-459-012
10mm, 32cm



Endoscopic Instruments Detach Scissors System



DETACH Scissors Insert

WI-460-001
Clearing brushes, pkg 6

DETACH Handle/Shaft

WI-460-002
ROTO-CAM, monopolar
5m, 32 cm



Supercut Detach Scissors
Unique Supercut blade has a finely-serrated lower blade that helps prevent tissue slippage, curved blades meet the contour of structures while the blunt shaped distal tip allows **tissue manipulation and cauterization** with blades closed, double action

WI-460-003
ROTO-CAM, monopolar
5mm, 32 cm

WI-460-004
Insert, 5 m, 32 cm

WI-460-005
Insert, 5mm, 32cm, pkg 3



Hook Detach Scissors
Classic hook blades designed to lift, isolate and transect tissue

WI-460-006
ROTO-CAM, monopolar
5mm, 32 cm

WI-460-007
Insert, 5 m, 32 cm

WI-460-008
Insert, 5mm, 32cm, pkg 3



Micro Detach Scissors
Curved,
Delicate, sharp-sharp
curved blades

WI-460-009
ROTO-CAM, monopolar
5mm, 32 cm

WI-460-010
Insert, 5 m, 32 cm

WI-460-011
Insert, 5mm, 32cm, pkg 3



Endoscopic Instruments Detach Scissors System



Micro Detach Scissors
Straight
Delicate, sharp-sharp
straight blades

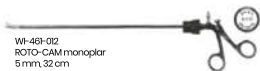

WI-461-012
ROTO-CAM monopolar
5 mm, 32 cm

WI-461-013
Insert, 5mm, 32cm

WI-461-014
Insert, 5mm, 32cm, pkg 3



Metzenbaum detach Scissors
Long, curved, tapered
blades with wide spread
double action



WI-461-015
ROTO-CAM monopolar
5 mm, 32 cm

WI-461-016
Insert, 5mm, 32cm

WI-461-017
Insert, 5mm, 32cm, pkg 3



"Baby" Metzenbaum Detach Scissors
Shorter, curved, very tapered
blades reach more narrow
and delicate dissection
areas, double action



WI-461-018
ROTO-CAM monopolar
5 mm, 32 cm

WI-461-019
Insert, 5mm, 32cm

WI-461-020
Insert, 5mm, 32cm, pkg 3



Mini detach Scissors
Curved, tapered, delicate
blades, double action



WI-461-021
ROTO-CAM monopolar
5 mm, 32 cm

WI-461-022
Insert, 5mm, 32cm

WI-461-023
Insert, 5mm, 32cm, pkg 3

Endoscopic Instruments

Biopsy Instruments



Biopsy Forceps
two sharp teeth, one
on each jaw, for biopsy
or secure hold of
thick-walled tissue



WI-462-001
1x1 teeth,
Spring-loaded,
5mm, 32 cm

WI-462-002
1x1 teeth,
Spring-loaded
5mm, 45cm



Biopsy Punches
Serrated lower jaw

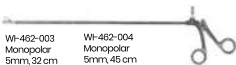

WI-462-003
Monopolar
5mm, 32 cm

WI-462-004
Monopolar
5mm, 45 cm



Hook Biopsy Punches
frangerheim-type
electrosurgical biopsy
punch with hook blade



WI-462-005
Monopolar
5mm, 32 cm

WI-462-006
Monopolar
5mm, 45 cm



Biopsy Punches
Single tooth in
upper jaw

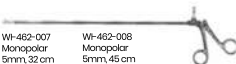

WI-462-007
Monopolar
5mm, 32 cm

WI-462-008
Monopolar
5mm, 45 cm



Biopsy Forceps
Oval-shaped
fenestrated jaws.

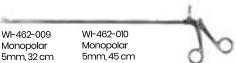

WI-462-009
Monopolar
5mm, 32 cm

WI-462-010
Monopolar
5mm, 45 cm

Endoscopic Instruments Specialization



Micro Biopsy Forceps
3mm jaws for biopsy of
small, delicate tissues

WI-468-001
Spring-loaded
5mm, 32cm



Spoon Forceps
Wide cup-shaped jaws for
tissue or stone removal

WI-468-002
Spring-loaded
10mm, 32cm



Cholangiogram Clamp
Channel for placement of
5Fr. or smaller cholangiogram
catheter

WI-468-003
Ratchet
5mm, 32cm



Cholangiogram Guide
Curved tip for simple
placement of cholangiogram
catheter

WI-463-004
5mm, 32cm



Bessler/Treat Suture Forceps
Uniquely designed jaws
allow easier grasp and
positioning of tubular
structure for placement
of purse string with straight
of curved needle

WI-408-005
10mm, 32cm





Microsurgical Forceps
with platform, round handle, 18.0 cm / 7"

- WH-464-001 - Curved 0.4mm micro tip
- WH-464-002 - Curved 0.5mm micro tip 1/2 teeth
- WH-464-003 - Curved 0.8mm delicate tip
- WH-464-004 - Curved 0.8 delicate 1 x 2
- WH-464-005 - Straight 0.4 mm micro tip
- WH-464-006 - Straight 0.5mm micro tip 1x2 teeth
- WH-464-007 - Straight 0.5mm microtip 1x2 teeth
- WH-464-008 - Straight, 0.8mm delicate tip 1 x 2 teeth



Rhoton Type Suture Tying forceps
with platform, round handle,
18.0 cm / 7" Straight
WH-464-009



Micro Suture Tying Forceps
With platform round handle
15.0cm / 6"

- WH-464-010 Curved
- WH-464-011 Straight

Micro Surgery Scissors



Wl-465-001 Wl-465-003
Serrated

Wl-465-002 Wl-465-004
Serrated

Microsurgical Scissors
wide handle, 15.0 cm / 6"
regular blade
Wl-465-001 - Wl-465-004



Wl-465-005

Wl-465-006

Microsurgical Scissors
wide handle, 5.0 cm / 6"
Micro blade
Wl-465-005 - Wl-465-006



Wl-465-007

Wl-465-008

Microsurgical Scissors
Round handle, 18.0cm / 7"
regular blade
Wl-465-007 - Wl-465-009

Wl-465-009
Angled to side, 60°



Wl-465-010

Wl-465-011

Microsurgical Scissors
Round handle, bayonet
shape, 21.0 cm, 8 1/4"
regular blade
Wl-465-010 - Wl-465-011

Micro Surgery Needle Holders



Microsurgical Needle Holders
round handle, 15.0 cm / 6"
Wf-466-001 - Wf-466-004

- Wf-466-001 Straight jaw
- Wf-466-002 Curved jaw
- Wf-466-003 Straight jaw, catch
- Wf-466-004 Curved jaw, catch



Microsurgical Needle Holders
wide handle, 15.0 cm / 6"
Wf-466-005 - Wf-466-006

- Wf-466-005 Straight jaw
- Wf-466-006 Curved jaw



Microsurgical Needle Holders
round handle, 18.0 cm / 7"
Wf-466-007 - Wf-466-014

- Wf-466-007 Straight jaw, micro tip
- Wf-466-008 Straight jaw, micro tip, catch
- Wf-466-009 Straight jaw, delicate tip
- Wf-466-010 Straight jaw, delicate tip, catch
- Wf-466-011 Curved jaw, micro tip
- Wf-466-012 Curved jaw, micro tip, catch
- Wf-466-013 Curved jaw, delicate tip
- Wf-466-014 Curved jaw, delicate tip, catch

Micro Surgery Scissors, Needle Holders and Forceps

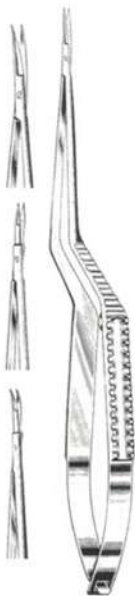

Yasargil Scissors
bayonet handle, 22.0cm / 8 3/4"
Wf-467-001 - Wf-467-004

Wf-467-001 Straight, regular blade
Wf-467-002 Curved, regular blade
Wf-467-003 Straight, micro blade
Wf-467-004 Curved, micro blade



Yasargil Needle Holders
bayonet handle, 22.0cm / 8 3/4"
Wf-467-005 - Wf-467-006

Wf-467-005 Straight, regular
Wf-467-006 Curved, regular



Yasargil Forceps
bayonet handle, 22.0cm / 8 3/4"
Wf-467-007 - Wf-467-008

Wf-467-007 Blunt tip
Wf-467-008 Sharp tip

Micro Surgery Scissors, Needle Holders



Jacobson Scissors,
straight handle, 18.5 cm / 7 1/4"
WJ-468-001 - WJ-468-003

WJ-468-001 Straight blade
WJ-468-002 Curved blade
WJ-468-003 Angled on edge



Jacobson Needle Holders,
straight handle, 18.0 cm / 7"
WJ-468-009 - WJ-468-010

WJ-468-009 Without catch
WJ-468-010 With catch



Jacobson Needle Holders,
straight handle, without catch
18.0 cm / 7"
WJ-468-011 - WJ-468-012

WJ-468-011 Straight jaw
WJ-468-012 Fine curved jaw



Jacobson Scissors,
straight handle, 18.5 cm / 7 1/4"
WJ-468-004 - WJ-468-008

WJ-468-004 Straight, regular blade
WJ-468-005 Curved, regular blade
WJ-468-006 Angled on edge, regular blade
WJ-468-007 Straight, micro blade
WJ-468-008 Curved, micro blade



Micro Surgery Needle Holders and Forceps



Microsurgical Needle Holders
18.0 cm / 7" Carb-Bite jaws

Wf-469-001 Smooth
Wf-469-002 Serrated



Microsurgical Needle Holders
21.5 cm / 8 1/2" Carb-Bite jaws

Wf-469-003 Smooth
Wf-469-004 Serrated



Jacobson Forceps
bayonet handle, 18.0 cm / 6 1/2"
sharp tips
Wf-469-005



Jacobson Forceps
bayonet handle, 18.5 cm / 7 1/4"

Wf-469-006 - Blunt tips
Wf-469-007 - Sharp tips
Wf-469-008 - Angled blunt tips

Ophthalmic Surgery

Eye Forceps



Eye Dressing Forceps
10.0 cm / 4" delicate
serrated, straight,
0.7mm wide at tip
WF-470-001

Eye Dressing Forceps
10.0 cm / 4"
serrated, straight,
0.8mm wide at tip
WF-470-002



Eye Dressing Forceps
9.9 cm / 3⁷/₈" delicate
serrated, half curved,
0.7mm wide at tip
WF-470-003

Eye Dressing Forceps
9.9 cm / 3⁷/₈"
serrated, half curved
0.8mm wide at tip
WF-470-004



Eye Dressing Forceps
9.7 cm / 3⁷/₈" delicate
serrated, full curved,
0.7mm wide at tip
WF-470-005

Eye Dressing Forceps
9.7 cm / 3⁷/₈" delicate
serrated, full curved,
0.7mm wide at tip
WF-470-006



Iris Forceps
10.0 cm / 4" delicate
straight, b2 tooth
0.7mm wide at tip
WF-470-007

Iris Forceps
10.0 cm / 4" delicate
straight, b2 tooth
0.8mm wide at tip
WF-470-008



Iris Forceps
9.9 cm / 3⁷/₈" delicate
half curved, b2 tooth
0.7mm wide at tip
WF-470-009

Iris Forceps
9.9 cm / 3⁷/₈" delicate
half curved, b2 tooth
0.8mm wide at tip
WF-470-010



Iris Forceps
9.7 cm / 3⁷/₈" delicate
full curved, b2 tooth
0.7mm wide at tip
WF-470-011

Iris Forceps
9.7 cm / 3⁷/₈" delicate
full curved, b2 tooth
0.8mm wide at tip
WF-470-012

Ophthalmic Surgery

Eye Forceps



Von Graefe Iris Forceps
7.2cm / 2¾", straight 0.7mm tip

WI-473-013 Serrated
WI-471-014 1x2 teeth



Von Graefe Iris Forceps
7.2cm / 2¾", curved, 0.7mm tip

WI-473-015 Serrated
WI-471-016 1x2 teeth



Gill Iris Forceps
7.5 cm / 3", curved, 0.5mm tip
1x2 teeth
WI-471-017



Bishop Harmon Iris Forceps
8.9 cm / 3½"

WI-471-018 - 0.6mm, 1 x 2 teeth
WI-471-019 - 0.4mm, 1 x 2 teeth, extra delicate
WI-471-020 - 0.3mm, 1 x 2 teeth micro surgery
WI-471-021 - 0.6mm, serrated



Gill Iris Forceps
7.5 cm / 3", curved, 0.6mm tip
1 x 2 teeth down
WI-471-022



Gill Iris Forceps
7.5 cm / 3", curved
cross-serrated
WI-471-023



Botvin Iris Forceps
7.5 cm / 3", bayonet-shaped
cross-serrated
WI-471-024





Elsching Fixation Forceps
10.6 cm/ 4 $\frac{1}{8}$ "
1 x 2 teeth
WI-472-001



Thorpe Conjunctival Fixation Forceps
9.5 cm/ 4 $\frac{1}{8}$ "
2 x 3 teeth with tying platform
WI-472-002



Von Graefe Fixation Forceps
11.4 cm/ 4 $\frac{1}{2}$ "
with catch, 4.5mm jaws
WI-472-003



Von Graefe Fixation Forceps
11.4 cm/ 4 $\frac{1}{2}$ "
plain, 4.5mm jaws
WI-472-004



Lester Fixation Forceps
9.7 cm/ 3 $\frac{7}{8}$ "
2 x 3 teeth
WI-472-005



Lester Fixation Forceps
9.7 cm/ 3 $\frac{7}{8}$ "
1 x 2 teeth
WI-472-006



Green Fixation Forceps
10.2 cm/ 4"
10mm jaws with fine teeth
WI-472-007



Bracken Fixation Forceps
10.8 cm/ 4 $\frac{1}{8}$ "
1 x 2 teeth
WI-472-008

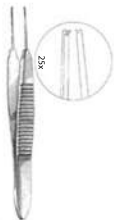

Bonn Iris Forceps
7.0 cm / 2 3/4"
0.12 mm teeth
original pattern,
without tying platform
WI-473-001

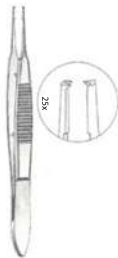

Bonn Suture Forceps
9.5 cm / 3 3/4"
0.12 mm teeth
5mm tying platform
WI-473-002



WI-473-003 - 0.12 mm teeth
WI-473-004 - 0.3mm teeth
WI-473-005 - 0.5 mm teeth

Troutman-Barrager Utility Forceps (Colibri-Type)
7.5 cm / 2 7/8", teeth at 45° angle
6mm tying platform

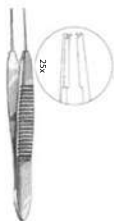

Bonn Iris Forceps
7.0 cm / 3 3/4"
0.12 mm teeth
4mm tying platform
WI-473-006



Girard Corneo-Scleral Forceps
(Colibri-Type)
10.8 cm / 4 1/4", for right hand
round knurled handle,
0.12 mm teeth, 6mm tying platform
WI-474-007



Girard Corneo-Scleral Forceps
(Colibri-Type)
10.8 cm / 4 1/4", for left hand
round knurled handle,
0.12 mm teeth, 6mm tying platform
WI-474-008



Castroviejo Corneo-Scleral
Suture Forceps
4" (10.2cm), 6mm tying platform
WI-474-009 - 0.5mm teeth
WI-474-010 - 0.9mm teeth
WI-474-011 - 1.5mm teeth



Castroviejo Colibri Forceps
10.8 cm / 4 1/4", wide handle,
0.5 mm teeth, 7mm tying platform
WI-474-012



Castroviejo Suture Forceps
10.8 cm / 4 1/4", wide angle,
6mm tying platform
WI-474-013 - 0.12mm teeth
WI-474-014 - 0.3mm teeth
WI-474-015 - 0.5mm teeth
WI-474-016 - 0.9mm teeth
WI-474-017 - 1.5mm teeth



Pierson Colibri Forceps
7.6 cm / 3"
WI-474-018 - 0.1mm teeth
WI-474-019 - 0.3mm teeth



Castroviejo Fixation Forceps
10.8 cm / 4 1/4", wide handle,
without tying platform
WI-474-020 - 0.3 mm teeth
WI-474-021 - 0.5mm teeth



Jewelers Style Forceps
Style 1: very fine
WI-475-001



Jewelers Style Forceps
Style 3: very fine
WI-475-002



Jewelers Style Forceps
Style 3C: very fine
WI-475-003



Jewelers Style Forceps
Style 4: very fine
WI-475-004



Jewelers Style Forceps
Style 5: very fine
WI-475-005



Jewelers Style Forceps
Style 7: very fine, curved
WI-475-006

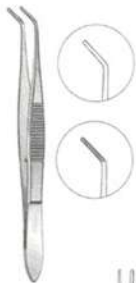

Nugent Utility Forceps
10.8 cm / 4", 45° angled jaws
WI-476-001- Smooth
WI-476-002- Cross-serrated



Wills Hospital Utility Forceps
10.2 cm / 4", cross rated
WI-476-003



McCullough Utility Forceps
10.2 cm / 4", cross-serrated
WI-476-004



McCullough Utility Forceps
10.2 cm / 4", cross-serrated
1 x 2 teeth
WI-476-005



Harms Suture Tying Forceps
10.8 cm / 4", Wide handle
6.5m tying platform

WI-476-006-Straight
WI-476-006-Curved

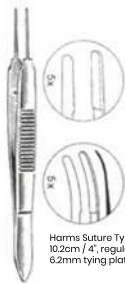

Harms Suture Tying Forceps
10.2cm / 4", regular handle,
6.2mm tying platform

WI-477-008 - Straight
WI-477-009 - Curved



Castroviejo Suture Tying Forceps
10.8cm / 4¼", 5mm tying platform
WI-477-010



**Troutman-Barraquer Corneal
Utility Forceps (Collibri-Type)**
7.1cm / 2¾", 0.12mm teeth
WI-477-011



Polack Double Corneal Forceps (Collibri-Type)
7.1cm / 2¾", 3mm long tips with 1 x 2 teeth
6.2mm tying platform
WI-477-012

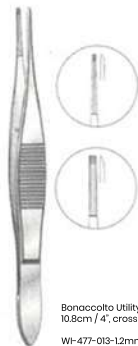

Bonaccolto Utility Forceps
10.8cm / 4", cross serrated

WI-477-013-1.2mm wide platform
WI-477-014-1.7mm wide platform



Chandler Iris Forceps
7.6 cm / 3"
WI-478-015

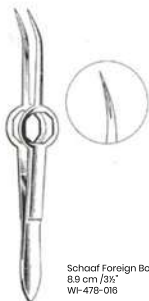

Schaaf Foreign Body Forceps
8.9 cm / 3½"
WI-478-016



Watzke Sieve Spreading Forceps
11.4 cm / 4½" cross-action
10mm serrated angled tips
WI-478-017

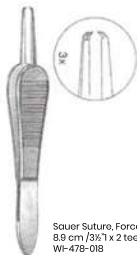

Sauer Suture Forceps
8.9 cm / 3½" 1 x 2 teeth
WI-478-018



McPherson Suture Tying Forceps
8.9 cm / 3½", straight
4.5mm tying platform
WI-479-019



McPherson Suture Tying Forceps
8.9 cm / 3½", angled
4.5mm tying platform
WI-479-020



McPherson Micro Corneal Forceps
8.9 cm / 3½", straight, 1 x 2 teeth
4.5mm tying platform
WI-479-021



McPherson Micro corneal Forceps
8.9 cm / 3½", angled,
1 x 2 teeth, 7.45mm tying platform
WI-479-022



Kalman-McPherson Suture Tying Forceps
8.6 cm / 3¼", angled,
7mm tying platform
WI-479-023



Kalman-McPherson Micro Corneal Forceps
8.9 cm / 3½", straight,
1 x 2 teeth, 7mm tying platform
WI-479-024



Sheets-McPherson Tying Forceps
8.3cm / 3¼", 45°, angled jaws
1mm cross-serrated tips,
10.5mm tying platform
WI-480-001



Sinskey Tying Forceps
11.1 cm / 4½", straight
10.5mm tying platform
WI-480-002

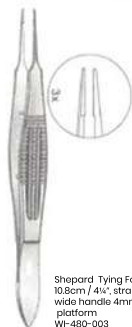

Shepard Tying Forceps
10.8cm / 4¼", straight
wide handle 4mm tying
platform
WI-480-003



Shepard Tying Forceps
10.8cm / 4¼", 45°
wide handle
4mm tying platform
WI-480-004

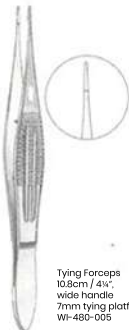

Tying Forceps
10.8cm / 4¼",
wide handle
7mm tying platform
WI-480-005

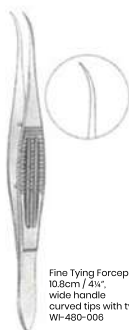

Fine Tying Forceps
10.8cm / 4¼",
wide handle
curved tips with tying surface
WI-480-006

Ophthalmic Surgery

Cilia Forceps and Lens Forceps



Ziegler Cilia Forceps
8.6cm / 3 1/4"
WI-481-001



Littauer Cilia Forceps
8.3cm / 3 1/8"
WI-481-002



Douglas Cilia Forceps
8.9cm / 3 1/2"
WI-481-003



Gracie Cilia Forceps
9.8cm / 3 7/8"
2mm wide platform
WI-481-004



Barraquer Cilia Forceps
10.2 cm / 4"
6mm long platform
WI-481-005



Shepard Intraocular
Lens Forceps
9.2 cm / 3 5/8", curved shafts
slide lock
15mm upper and
2mm lower serrated jaws
WI-481-006



Clayman Lens Forceps
12.0 cm / 4 3/4", curved shafts
3mm angled tips
WI-481-007



Thornton Intractor
Lens Forceps
8.6 cm / 3 3/8"
11mm angled jaws 45°
WI-481-008

Ophthalmic Surgery

Chalazion Forceps



Lambert Chalazion Forceps
9.2cm / 3 $\frac{3}{4}$ "
8mm inside diameter
of fenestrated jaw
WI-482-001



Health Chalazion Forceps
9.5cm / 3 $\frac{1}{4}$ "
12mm x 14mm inside diameter
of fenestrated jaw
WI-482-002



Hunt Chalazion Forceps
9.5cm / 3 $\frac{1}{4}$ "
12mm inside diameter
of fenestrated jaw
WI-482-003



Desmarres Chalazion Forceps
8.9cm / 3 $\frac{1}{2}$ "

WI-482-004 11mm x 17mm inside
diameter of
fenestrated jaw

WI-482-005 11.5mm x 22.5mm
inside
diameter of
fenestrated jaw

WI-482-006 16.5mm x 28mm
inside
diameter of
fenestrated jaw



Lordan Chalazion Forceps
9.5cm / 3 $\frac{3}{4}$ "
7.5 x 12mm inside dimensions
of fenestrated jaw
WI-482-007



Francis Chalazion Forceps
9.5cm / 3 $\frac{1}{4}$ "
12 x 14mm inside diameter
of fenestrated jaw

WI-482-008



Snellen Entropium Forceps
8.5cm / 3 $\frac{1}{2}$ "; 35mm
wide solid plate

WI-482-009 Left
WI-482-010 right (illustrated)

Ophthalmic Surgery Capsule and Muscle Forceps



Arruga Capsule Forceps
10.2cm / 4"
WI-483-001



Castrovieja Capsule Forceps
10.2cm / 4", cross action
WI-483-002

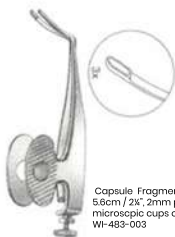

Capsule Fragment and Clot Forceps
5.6cm / 2 1/4", 2mm platform and
microscopic cups on inner jaw surface
WI-483-003



Berke Ptsis Clamp
10.2 cm / 4", 20mm jaws
WI-483-004



Jameson Muscle Recession Forceps
10.2 cm / 4"

- WI-483-005 Left, 12mm jaws
- WI-483-006 Left, 7mm jaws
- WI-483-007 right, 12mm jaws
- WI-483-008 right, 7mm jaws



Troutman superior Rectus Forceps
10.5 cm / 4 1/4",
45° angle 10mm from tip to bend
WI-483-009 Left, 12mm jaws

Ophthalmic Surgery Needle Holders



Kalt Needle Holder
13.3cm / 5¼", 12mm jaws, straight
serrated thumb plate with lock
WI-484-001



Kalt Needle Holder
13.3cm / 5¼", 10mm jaws,
smooth thumb plate with lock
WI-484-002 Straight
WI-484-003 Curved right
WI-484-004 Curved left



Castroviejo Needle Holder
14.0 cm / 5½", 11mm smooth jaws,
flat serrated plate with lock
WI-484-005 Curved
WI-484-006 Straight



Castroviejo Needle Holder
14.0 cm / 5½", 10mm smooth jaws,
flat serrated plate with lock
WI-484-007 straight,
WI-484-008 Curved,



Castroviejo Needle Holder
13.0 cm / 5", 9mm smooth jaws,
wide serrated plate with lock
WI-484-009 straight, without lock
WI-484-010 Curved, without lock
WI-484-011 straight with lock
WI-484-012 Curved, with lock



Castroviejo Needle Holder
14.0 cm / 5½", 11mm smooth jaws,
flat serrated plate with lock
WI-484-013 Smooth
WI-484-014 Serrated

Ophthalmic Surgery Needle Holders



Barraquer Needle Holders
13.3cm 5/8", 9mm curved jaws
round knurled handle

WI-485-015 With lock
WI-485-016 Without lock



Barraquer Needle Holders
10.2cm 5", 10mm smooth jaws
round knurled handle

WI-485-017 Staright, Without lock
WI-485-018 Staright With lock
WI-485-019 Curved Without lock
WI-485-020 Curved With lock



McPherson Needle Holders
10.2cm 4", 10mm smooth jaws
flat serrated handle

WI-485-021 Staright, Without lock
WI-485-022 Staright With lock
WI-485-023 Curved Without lock
WI-485-024 Curved With lock



Anis Needle Holders
13.0 cm 5", 8mm smooth jaws
round knurled handle without lock

WI-485-025 Straight
WI-485-026 Curved



Anis Needle Holders
13.0 cm 5", 8mm smooth jaws
round knurled handle with lock

WI-485-027 Straight
WI-485-028 Curved



Cohan Miniature
Needle Holders
10.4 cm 4 1/8", 8mm smooth
curved jaws
round knurled handle

WI-485-029 without lock
WI-485-030 with lock



Troutman Needle Holders
11.7 cm 4 1/4", 10mm smooth
curved jaws
round serrated handle
without lock

WI-485-031

Ophthalmic Surgery Scissors



Knapp Iris Scissors
10.1cm / 4", 25mm blades

WI-486-001 Straight, sharp-sharp
WI-486-002 Curved, sharp-sharp

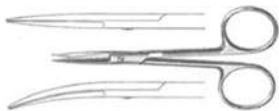

Knapp Iris Scissors
10.1cm / 4", 25mm blades

WI-486-003 Straight, sharp-blunt
WI-486-004 Curved, sharp-bunt

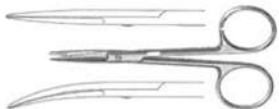

Knapp Iris Scissors
10.1cm / 4", 25mm blades

WI-486-005 Straight, blunt-blunt
WI-486-006 Curved, blunt-bunt

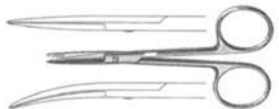

Iris Scissors
11.4cm / 4 1/2", 25mm blades

WI-486-007 Straight, sharp-blunt
WI-486-008 Curved, blunt-bunt

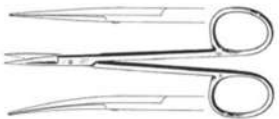

Iris Scissors
11.4cm / 4 1/2", Carb-edge
25mm blades

WI-486-009 Straight,
WI-486-010 Curved,

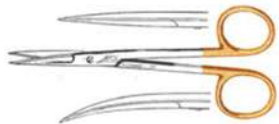



Supercut Iris Scissors
11.4cm / 4 1/2", 25m blades

WI-487-011 Straight
WI-487-012 Curved



Iris Scissors
11.4cm / 4 1/2", angled over edge
25m blades
WI-487-013

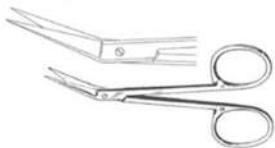

Iris Scissors
11.4cm / 4 1/2", angled over edge
25m blades, proce points
WI-487-014

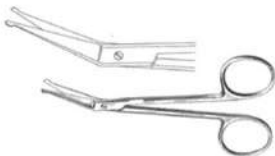

Iris Scissors
2mm blades

WI-487-015 8.9cm / 3 1/2", straight
WI-487-016 9.9cm / 3 1/2", curved
WI-487-017 10.5cm / 4 1/8", delicate, straight
WI-487-018 10.5cm / 4 1/8", delicate, curved



Ophthalmic Surgery Scissors



Wilmer Conjunctival Scissors
10.5cm, 4 $\frac{1}{2}$ " delicate, 15 mm blades
angled on flat
WI-488-019



Iris Scissors
10.2cm, 4", 24mm blades
large finger rings

WI-488-020 Straight
WI-488-021 Curved

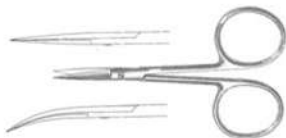

Iris Scissors
10.5cm, 4 $\frac{1}{4}$ ", delicate, 27mm blades

WI-488-022 Straight
WI-488-023 Curved



Iris Scissors
10.2cm, 4", 22mm blades
flat shanks

WI-488-024 Straight
WI-488-025 Curved



Iris Scissors
8.9cm, 3 $\frac{1}{2}$ ", delicate, 22mm blades
flat shanks

WI-488-026 Straight
WI-488-027 Curved





Utility Scissors
10.5 cm / 4 $\frac{1}{4}$ " 15 mm blades
flat shanks

WI-489-028 Straight
WI-489-029 Curved



Strabismus Scissors
11.4cm / 4 $\frac{1}{2}$ " 130mm blades

WI-489-030 Straight
WI-489-031 Curved

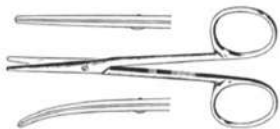

Strabismus Scissors
11.4cm / 4 $\frac{1}{2}$ " 30mm blades, Carb-edge

WI-489-033 Straight
WI-489-033 Curved



Strabismus Scissors
10.5 cm / 4 $\frac{1}{4}$ " 25mm blades
flat shanks

WI-489-034 Straight
WI-489-035 Curved

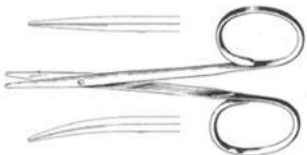

Ophthalmic Surgery

Eye Scissors



Stevens Tenotomy Scissors, blunt tips

WI-490-001 11.4 cm / 4 $\frac{1}{2}$ ", straight, slender pattern, 13mm blades
WI-490-002 11.4 cm / 4 $\frac{1}{2}$ ", curved, slender pattern, 13mm blades
WI-490-003 11.4 cm / 4 $\frac{1}{8}$ ", straight, standard pattern, 12mm blades
WI-490-004 11.4 cm / 4 $\frac{1}{8}$ ", straight, standard pattern, 12mm blades

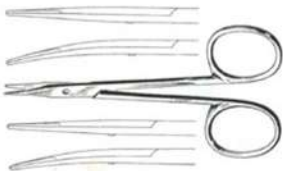

Stevens Tenotomy Scissors 9.5 cm / 3 $\frac{1}{4}$ ", 13mm blades blunt tips, flat shanks

WI-490-005 Straight
WI-490-006 Curved



Westcott Utility Scissors 13.0cm / 5 $\frac{1}{4}$ ", 23mm blades curved round sharp tips WI-490-007



Westcott Tenotomy Scissors 11.4cm / 4 $\frac{1}{2}$ ", 18mm blades rond blunt tips

WI-490-008 Right, curved
WI-490-009 Left, curved
WI-490-010 Straight

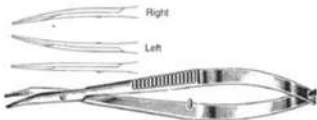

Ophthalmic Surgery

Eye Scissors



Stevens Stitch Scissors
10.5cm / 4 $\frac{1}{4}$ " 14mm blades
curved, sharp tips
WI-49I-01



Stevens Stitch Scissors
9.5cm / 4 $\frac{1}{4}$ " 12mm blades
curved, sharp tips, flat shanks
WI-49I-02



Westcotts Stitch Scissors
11.5cm / 4 $\frac{1}{2}$ " 18mm blades
curved, fine, sharp tips,
WI-49I-013



Stitch Scissors
12.4cm / 4 $\frac{1}{4}$ " 13mm blades
curved, fine, sharp tips, flat shanks
WI-49I-014



Enucleation Scissors
13.0cm / 5 $\frac{1}{8}$ " 32mm blades
strong curve
WI-49I-015



Stitch Scissors
9.8 cm / 3 $\frac{7}{8}$ " 15mm blades
semi-sharp tips

WI-49I-017 Straight
WI-49I-018 Curved



Gradle Stitch Scissors
9.5 cm / 3 $\frac{7}{8}$ " 13mm blades
blunt tips
WI-49I-019



O'Brien Suture Scissors
9.5 cm / 3 $\frac{7}{8}$ " 15mm blades
angled
WI-49I-020

Enucleation Scissors
13.0cm / 5" 27mm blades
light curve
WI-49I-016

Ophthalmic Surgery

Eye Scissors



Micro Stitch Scissors
10.2 cm / 4" 7mm blades
fine sharp tips

WI-492-021 Straight
WI-492-022 Curved



Micro Stitch Scissors
11.4 cm / 4 1/2" 16mm blades
sharp tips

WI-492-023 Straight
WI-492-024 Curved



McClure Iris Scissors
11.4 cm / 4 1/2" 14mm blades
angled on flat

WI-492-025



Castroviejo Corneal Scissors
10.8 cm / 4 1/4" 12mm blades
curved, blunt tips

WI-492-026



Castroviejo Iris Scissors
9.5cm / 3 3/4", 11 m blades
curved, sharp tips

WI-492-027



Castroviejo Corneal Scissors
10.8cm / 4 1/4", 12 m blades
angled, blunt tips

WI-492-028



Castroviejo Corneal Section Scissors
10.8cm / 4 1/4", curved, blunt tips

WI-492-029 Right, standard, 13mm blades
WI-492-030 Left, standard, 13mm blades
WI-492-031 Right, miniature, 11mm blades
WI-492-032 Left, miniature, 11mm blades

Ophthalmic Surgery

Eye Scissors



Castroviejo Corneal Section Scissors
10.2 cm / 4" microsurgery 7mm blades
curved, blunt tips

WI-493-033 right
WI-493-034 left



Castroviejo Corneal Section Scissors
10.5 cm / 4 1/8" miniature 7mm blades
curved, blunt tips

WI-493-035 Left
WI-493-036 Right



Troutman-Castroviejo Corneal Section Scissors
10.5 cm / 4 1/8" miniature 7mm blades
curved, blunt tips

WI-493-037 Left
WI-493-038 Right



Vannas Capsulotomy Scissors
8.2cm / 3 1/8", sharp tips

WI-493-039 Straight, 6mm blades
WI-493-040 Curved, 6mm blades
WI-493-041 Angled to side, 6mm blades
WI-493-042 Angled on flat, 6mm blades



Ophthalmic Surgery

Eye Scissors



Katzin Corneal Transplant Scissors
10.8cm / 4 1/8", miniature 8mm blades
curved, blunt tips

WI-494-043 left
WI-494-044 right



McPherson-Vannas Iris Scissors
8.2cm / 3 1/8", 5mm blades
curved, sharp tips
WI-494-045



Gills-Weish Vannas Scissors
angled, sharp tips

WI-494-046 7.9cm / 3 1/8"; microsurgery 5mm blades
WI-494-047 8.6cm / 3 3/8"; microsurgery 00mm blades



Barraquer-Dowecker Iris Scissors
5.7cm / 2 1/8", 7m blades,
angled on flat, blunt tips
WI-494-048



Ophthalmic Surgery Eye Calipers



Castroveijo Caliper
8.2 cm / 3 $\frac{1}{8}$ ", straight, measures from
0mm to 20 mm in 1mm increments
WI-495-001



Castroveijo Marking Caliper
8.2 cm / 3 $\frac{1}{8}$ ", straight, measures from
0mm to 20 mm in 1mm increments
with grooves for marking fluid
WI-495-002



Thrope Caliper
121 cm / 4 $\frac{7}{8}$ ", measures from
0mm to 80 mm in 1mm increments
and 0 to 3 inches in $\frac{1}{4}$ increments
WI-495-003



Jameson Caliper
8.6 cm / 8 $\frac{3}{8}$ ", measures from
0mm to 80 mm in 1mm increments
and 0 to 3 inches in $\frac{1}{4}$ increments
WI-495-004



Ophthalmic Surgery Rulers and Probes



Steel Rule
graduated 15.0cm / 6"
WI-496-001



Steel Rule
graduated 30.0cm / 12"
WI-496-002



Bowman Lacrimal Probes
12.4cm / 4 7/8", double-ended, silver

WI-496-003 Sizes 0000-000
WI-496-004 Sizes 000-0
WI-496-005 Sizes 1-2
WI-496-006 Sizes 3-4
WI-496-007 Sizes 5-6
WI-496-008 Sizes 7-8



Williams Lacrimal Probes
12.4cm / 4 7/8", double-ended, silver

WI-496-009 Sizes 0000-000
WI-496-010 Sizes 000-0
WI-496-011 Sizes 1-2
WI-496-012 Sizes 3-4
WI-496-013 Sizes 5-6
WI-496-014 Sizes 7-8



Surgical Instruments Made Right :)



+92 52 3562980 / 3255643
waqar.weldonind@gmail.com
www.weldonind.com



Weldon Industries (Pvt.) Ltd.
Shatab Garh Rd, Rawailpura,
Sialkot, Punjab 51310
Pakistan