



Weldon Industries
The Instruments Company



Dental

CATALOGUE

www.weldonind.com



Dental Surgery

Dental Forceps, English Pattern



for upper incisors and cuspids
WI-001-001 # 1

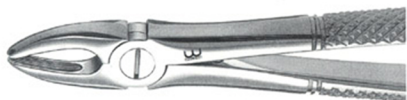

for upper cuspids and Bicuspids
WI-001-002 # 2



for lower incisors and cuspids
WI-001-003 # 4



FOR UPPER BICUSPIDS
WI-001-004 # 7



Dental Surgery

Dental Forceps, English Pattern

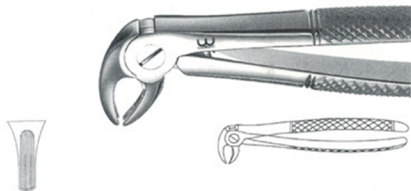

for lower Bicuspids
WI-02-005 # 13

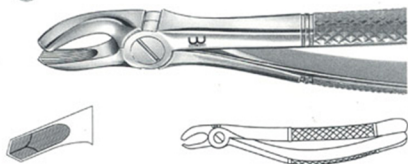

for Upper Molars, right
WI-02-006 # 17

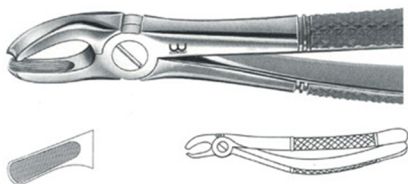

for Upper Molars, left
WI-02-007 # 18

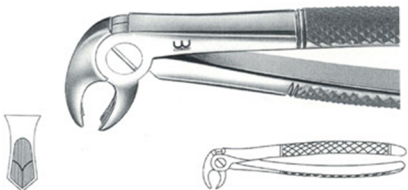

for Lower Molars,
WI-02-008 # 22

Dental Surgery

Dental Forceps, English Pattern



for upper incisors and roots
WI-003-009 # 29



for upper roots of incisors, narrow jaw
WI-003-010 # 29 N

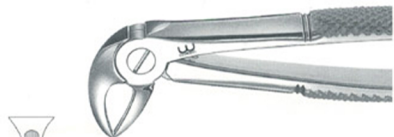

for Lower Roots
WI-003-011 # 29 N



for Lower Roots, narrow jaw
WI-003-012 # 33 A



Dental Surgery

Dental Forceps, English Pattern

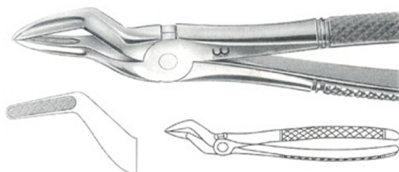

For Upper Roots
WI-004-013 # 51

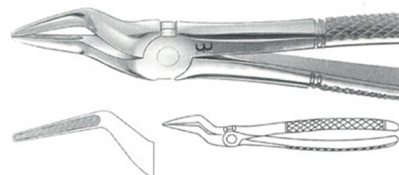

For Upper Roots, narrow jaw
WI-004-014 # 51 A

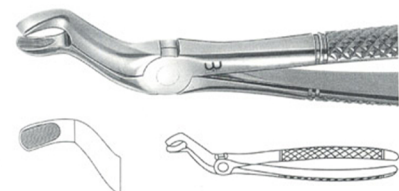

For Upper Wisdoms
WI-004-015 # 67

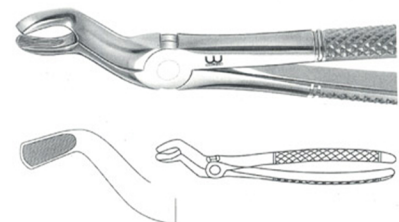

For Upper Wisdoms
WI-004-016 # 67 A

Dental Surgery

Dental Forceps, English Pattern

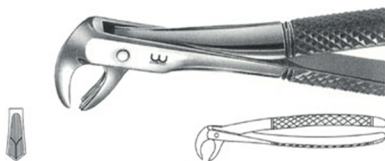

For Lower Molars
WI-005-017 # 73

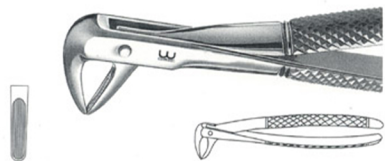

For Lower Incisors and roots
WI-005-018 # 74

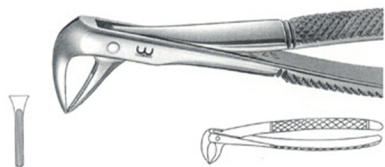

For Lower Incisors and roots
narrow jaw
WI-005-019 # 74 N

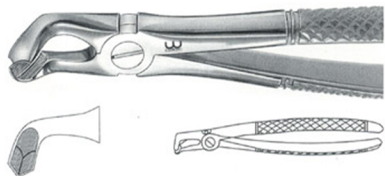

For Lower Wisdom
WI-005-020 # 79

Dental Surgery

Dental Forceps, English Pattern

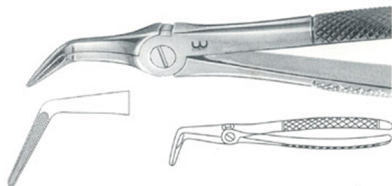

for lower molars and roots tips
WI-006-021 # 48 L

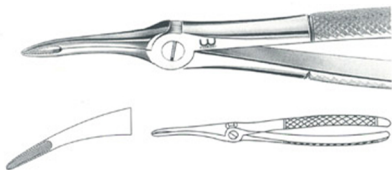

for lower molars and roots tips
WI-006-022 # 49

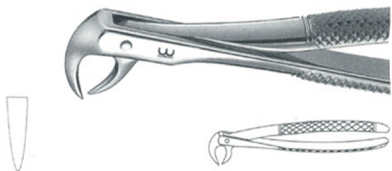

for lower molars
WI-006-023 # 86 A

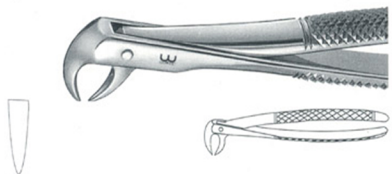

for lower molars
WI-006-024 # 86 B

Dental Surgery

Dental Forceps, English Pattern



For Lower Roots
WI-007-025 # 233

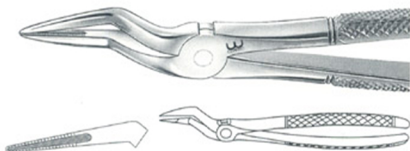

For Lower Roots
WI-007-026 # 235

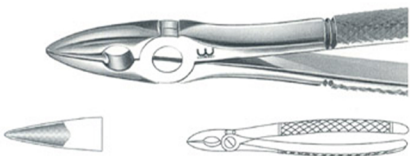

Mead
For Upper incisors, Bicuspids and roots
WI-007-027 # MD1

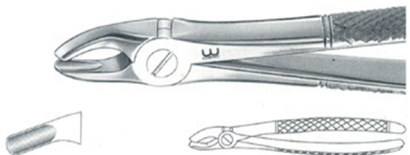

Mead
For Upper Molars
WI-007-028 # MD2

Dental Surgery

Dental Forceps, English Pattern

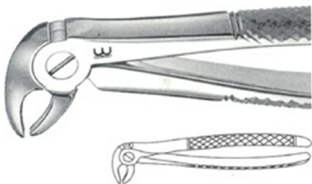

Mead
for Lower Incisors, Bicuspid and Roots
WI-008-029 # MD 3



Mead
for Lower Molars
WI-008-030 # MD 4



Witzel
for Lower Roots
WI-008-031 # 501

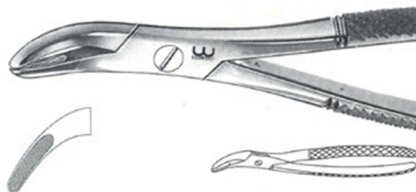

Witzel
for Lower Roots
WI-008-032 # 502

Dental Surgery

Dental Forceps, English Pattern

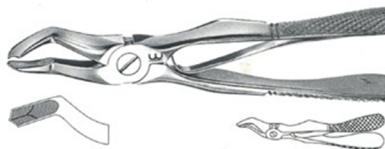

Klein
for children, for upper Molars
WI-009-033 # 3

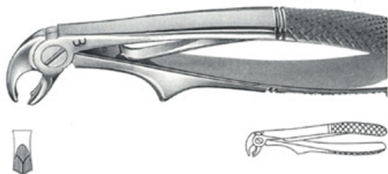

Klein
for children, for Lower Molars
WI-009-034 # 6



Klein
for children, for Lower Roots and incisors
WI-009-035 # 7

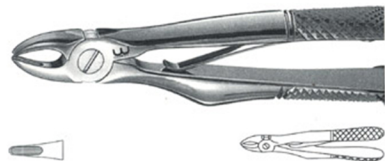

Klein
for children, for Upper incisors and
Cuspids
WI-009-036 # 137

Dental Surgery Dental Forceps, English Pattern



Klein
for children, for Upper Bicuspids
WI-010-037 # 139



Klein
for children, for Upper Roots
WI-010-038 # 51 S



Dental Surgery Dental Forceps, American Pattern



- * more than 40 years of manufacturing tradition
- * complete range

Extraction Forceps, American Pattern



- * serrated jaw edges
- * 3 years warranty on labour and material

Dental Surgery

Dental Forceps, American Pattern



for upper incisors and cuspids
WI-012-039 #1 Standard



Henahan
for Upper Incisors
WI-012-040 #1A



Woodward
for lower Molars
WI-012-041 #3 FS



Spaltzango
Splitting and Separating Forceps
WI-012-042 #6



Dental Surgery

Dental Forceps, American Pattern



for Upper Molars, Hook Handle
WI-013-043 # 10 H



for Upper Molars
WI-013-044 # 10 S



for 1st and 2nd Lower Molars
WI-013-045 # 15



"Cow-Horn" for 1st and 2nd Molars
WI-013-046 # 16



Dental Surgery

Dental Forceps, American Pattern

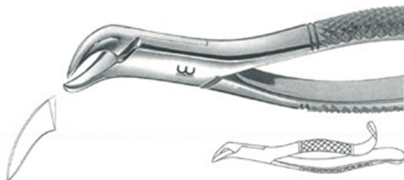

"Cow Horn" for children, for lower Molars
WF-014-047 # 16 SK

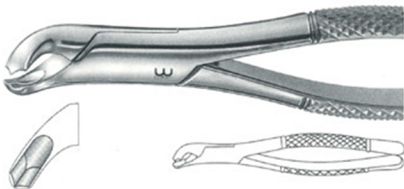

for 1st and 2nd lower Molars
WF-014-048 # 17
WF-014-048 # 17 GoldPlated

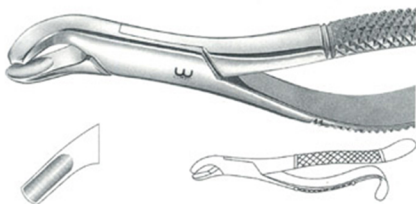

for 1st and 2nd Upper Molars, Left
WF-014-049 # 18 L

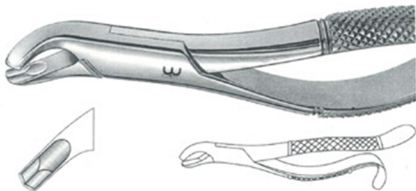

for 1st and 2nd Upper Molars, right
WF-014-050 # 18 R

Dental Surgery

Dental Forceps, American Pattern



"Cow Horn" for lower Molars
WI-015-051 #23



for Upper Molars
WI-015-052 #24

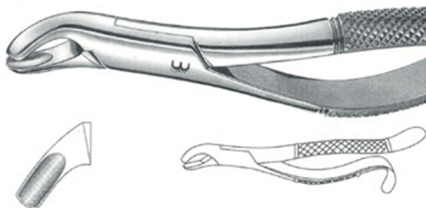

for Upper Molars
WI-015-053 #27

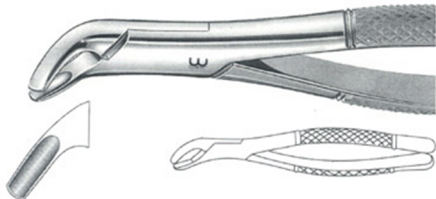

for Upper Bicuspids
WI-015-054 #32

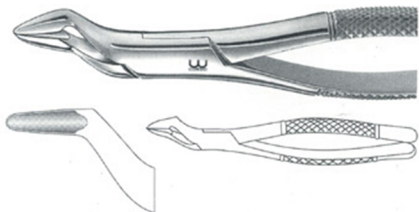

Dental Surgery

Dental Forceps, American Pattern

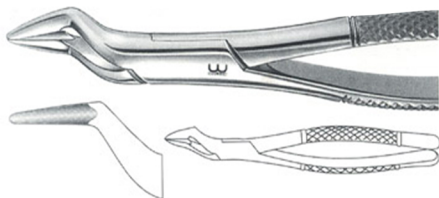

Pamly
for Upper Bicuspids and Roots
WI-016-055 # 32 A

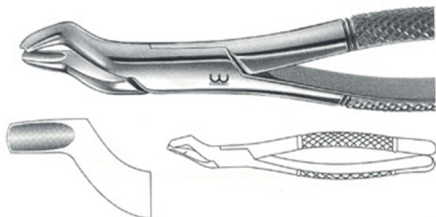

for Upper Molars, Left
WI-016-056 # 53 L
WI-016-056A # 53 L GOLD PLATED

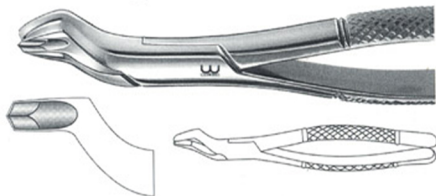

for Upper Molars, right
WI-016-057 # 53 R
WI-016-057A # 53 R GOLD PLATED

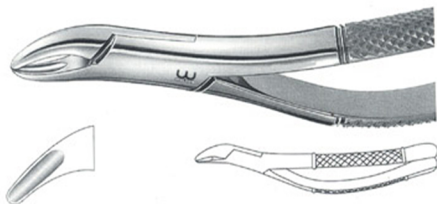

for Upper and Lower Incisors
WI-016-058 # 62

Dental Surgery

Dental Forceps, American Pattern

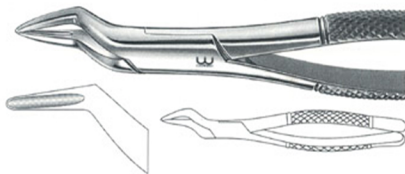

for upper Incisors, Roots and Fragments
WI-07-059 # 65
WI-07-059 A # 65 GOLD PLATED

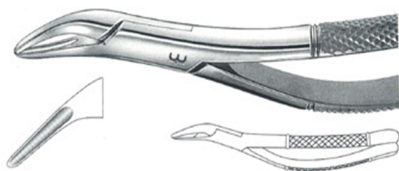

for upper and lower , Roots and Fragments
WI-07-060 # 69
WI-07-060 A # 69 GOLD PLATED

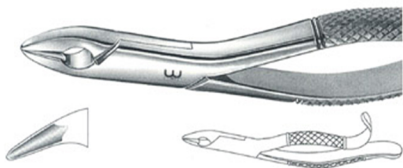

for Lower Molars and Bicuspidis
WI-07-061 #85 A

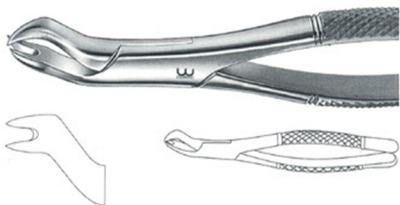

Nevius
for Upper Molars, Lefts
WI-07-062# 88 A

Dental Surgery

Dental Forceps, American Pattern



Nevius
for Upper Molars, right
WI-018-063 # 88R



for Upper Molars, left
WI-018-064 # 89



for Upper Molars, left
WI-018-065 # 90

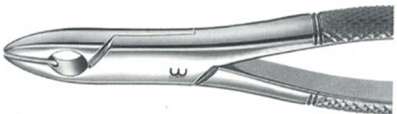

Kells
for Upper Incisors and Bicuspids
WI-018-066 # 99 C



Dental Surgery

Dental Forceps, American Pattern



Hull
Universal for Bicuspids and Deciduous
WI-019-067 # 101



for Lower Incisors, Bicuspids and Roots
WI-019-068 # 103



Nevius
for Upper Bicuspids and Cuspids
WI-019-069 # 110 S



Cryer
for Upper Incisors, Bicuspids and Roots
WI-019-070 # 150
WI-019-070A # 150 GOLD PLATED



Dental Surgery

Dental Forceps, American Pattern

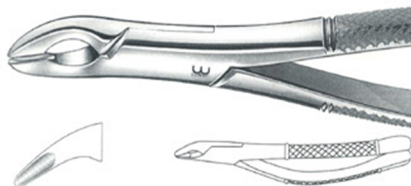

Cryer
for upper Incisors and Cuspids and Bicuspids
WI-020-071 # 150 A

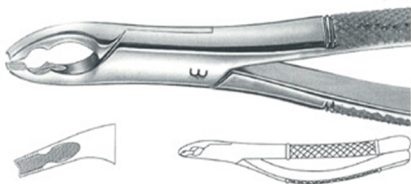

Cryer
for upper Incisors and Cuspids
serrated jaw
WI-020-072 # 150 x AS

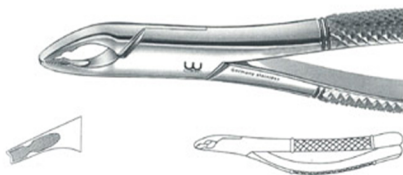

for children, for upper Incisors and Cuspids
serrated jaw
WI-020-073 # 150 x AS

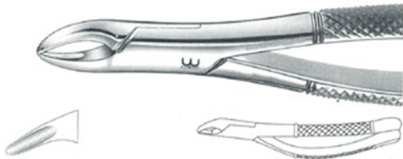

Cryer
For children, for upper Incisors, Bicuspids and roots
WI-020-074 # 150 S
WI-020-074A # 150 S Gold plated

Dental Surgery

Dental Forceps, American Pattern

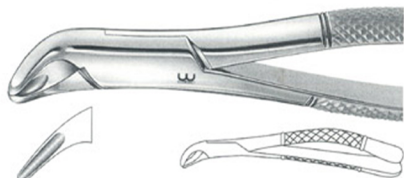

Cryer
for Lower Incisors, Bicuspids and Roots
WI-021-075 # 151 A
WI-021-075A # 151 GOLD PLATED

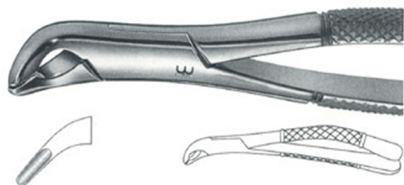

Cryer
for Lower Incisors, Cuspids, and Bicuspids
WI-021-076 # 151 A

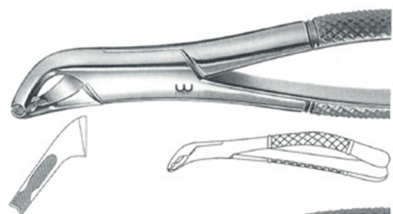

Cryer
for Lower Incisors and Cuspids, serrated jaw
WI-021-077 # 151 AS

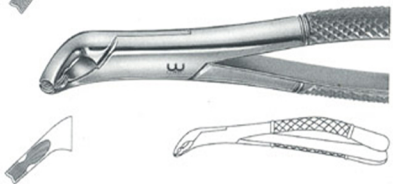

For Children, for Lower Incisors and Cuspids, serrated jaw
WI-021-078 # 151 XAS

Dental Surgery

Dental Forceps, American Pattern

Cryer
for children, for Lower Incisors, Bicuspids and
Roots
WI-022-079 # 151 S
WI-022-079A # 151 S GOLD PLATED

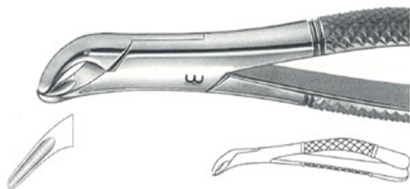

For Upper Wisdom, Hook Handle
WI-022-080 # 210 H

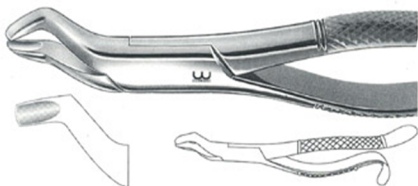

For Upper Wisdom
WI-022-081 # 210 S

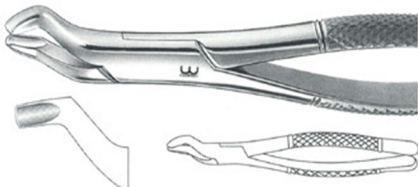

For Lower Molars
WI-022-082 # 217

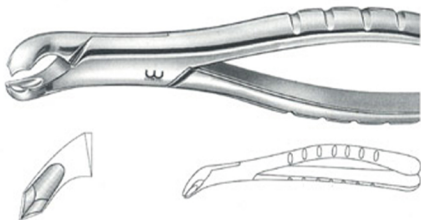

Dental Surgery

Dental Forceps, American Pattern



for Lower Wisdoms
WI-023-083 # 222



for Upper Incisors, Bicuspids and Roots
WI-023-084 # 288

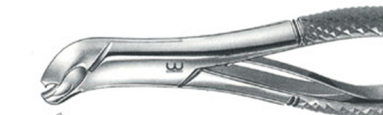

for children for Lower Molars
WI-023-085 # 17 SK



for children for Lower Molars
WI-023-086 # 23 SK



Dental Surgery

Dental Forceps, American Pattern



For children, for Upper Incisors, Bicuspid and
Roots
WI-024-067 # 150 SK



For children, for Lower Incisors, Bicuspid and
Roots
WI-024-088e # 151 SK



Root Elevators Handles for Root Elevators



WI-025-001



WI-025-002



WI-025-003



WI-025-004



WI-025-005

Root Elevators Handles for Root Elevators

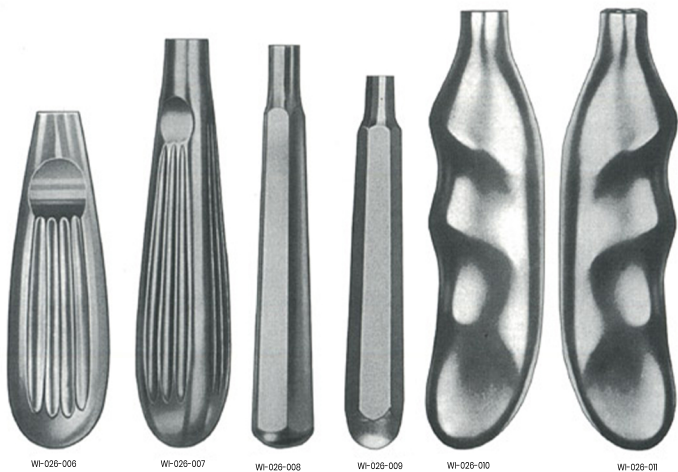

Examples:



Root Elevators

Root Elevstors



APICAL
WI-027-014
301



WI-027-015
3 mm
302

APICAL



WI-027-016
3 mm
303



APICAL
WI-027-017
304



WI-027-018
12A



WI-027-019
2

SELDIN



WI-027-020
3



SELDIN
WI-027-021
5



SELDIN
WI-027-022
34



SELDIN
WI-027-023
34S



SELDIN
WI-027-024
IL



WI-027-025
IR



WI-027-026
4 L



SELDIN
WI-027-027
4 R



WI-027-028



WI-027-029



WI-027-030



WI-027-031

Root Elevators

Root Elevstors



FLOHR
WI-028-032
0



FLOHR
WI-028-033
1



WI-028-034
2



FLOHR
WI-028-035
3



WI-028-036
5



FLOHR
WI-028-037
6



CRYER
WI-028-038
3A



CRYER
WI-028-039
12



WI-028-040
27



CRYER
WI-028-041
28



WI-028-042
39



CRYER
WI-028-043
40



WI-028-044
344



WI-028-045
349



WI-028-046



WI-028-047

Root Elevators

Root Elevators



WI-029-049
3 mm
1



WI-029-050
4 mm
2



WI-029-051
2 mm
0



WI-029-052
3 mm
1



WI-029-053
4 mm
2



WI-029-054
2 mm
0



WI-029-055
3 mm
1



WI-029-056
4 mm
2



WI-029-057
5 mm



WI-029-058
3.5 mm



WI-029-059



WI-029-060
5 mm
3



WI-029-061



WI-029-062



WI-029-063



WI-029-064



WI-029-065

Root Elevators

Root Elevators



WI-030-066
3 mm



WI-030-067
3.5 mm



WI-030-068
4.5 mm



WI-030-069
3.5 mm



WI-030-070
3.5 mm



WI-030-071



WI-030-072
3 mm



WI-030-073
3 mm



FRIEDMAN
WI-030-074



FRIEDMAN
WI-030-075



FRIEDMAN
WI-030-076



HEIBRINK
WI-030-077



HEIBRINK
WI-030-078



HEIBRINK
WI-030-079



WI-030-080



WI-030-081

Root Elevators

Root Elevators

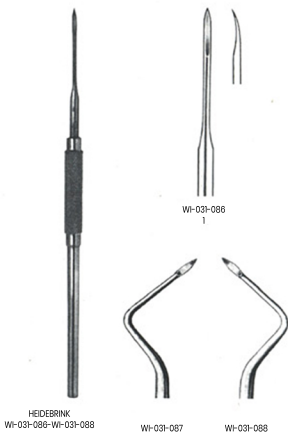
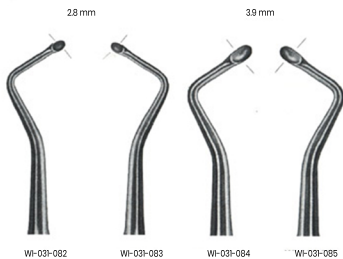

Root Elevators

Root Elevators



HYLIN-HEIDEBRINK





WI-033-104



WI-033-105



WI-033-106

Root Elevators

Root Elevators



HEIDBRINK
WI-034-107



WI-034-108
1



WI-034-109
2



WI-034-110
3



WI-034-111



WI-034-112



WI-034-113

Root Elevators

Root Elevators



WHITE
WI-035-114
3A



WHITE
WI-035-115



WHITE
WI-035-116



CRANE PICK
WI-035-117
50



WALTER F. BARRY
WI-035-118
50 WI-035-119
50



MILLER
WI-035-120
8



WI-035-121
9



MILLER

23
10

WI-035-123
11



HYLIN
WI-035-124
1



HYLIN
WI-035-125
2



HYLIN
WI-035-126
5



HYLIN
WI-035-127
6



WI-035-128

WI-035-129

4 mm

4.5 mm

4.6 mm

11 mm

8.2 mm

4 mm



WI-035-130



WI-035-131



WI-035-132



WI-035-133



WI-035-134



WI-035-135



WI-035-136



WI-035-137

Root Elevators

Root Elevators

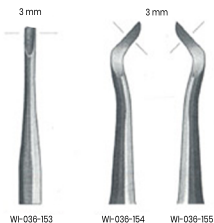
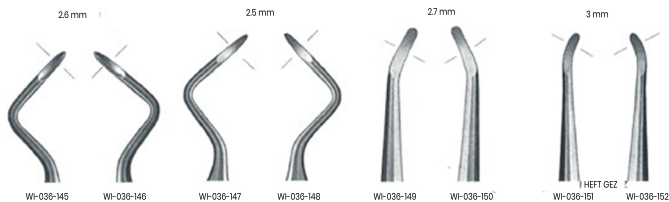
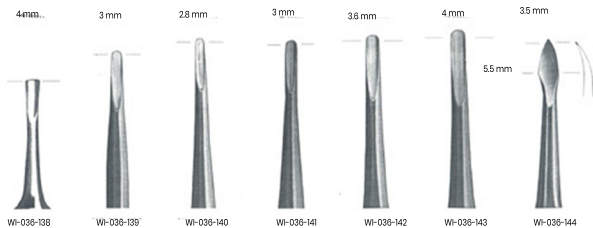

Root Elevators

Root Elevators



WI-037-156
46



WI-037-157



LINDO-LEVEIN
WI-037-158



WI-037-159
1



BERTEN
WI-037-160



WI-037-161
1



WI-037-162
3.5 mm



WI-037-163
3.5 mm



WI-037-164
3 mm
3



WI-037-165
3 mm
4



WI-037-166
2 mm
60

WI-037-167



WI-037-168
3 mm
61



WI-037-169
4 mm



WI-037-170
5 mm



WI-037-171
4.5 mm



WI-037-172
4 mm

WI-037-173
5 mm



WI-037-174
5 mm

WI-037-175
5 mm



WI-037-176
4 mm



WI-037-177
4 mm



WI-037-178
2.5 mm

Root Elevators

Root Elevators

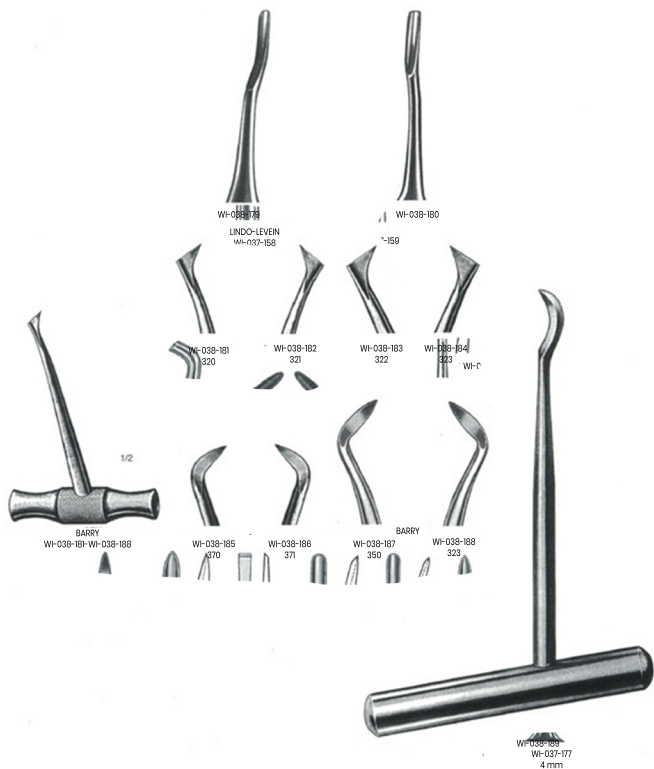

Root Elevators

Root Elevators

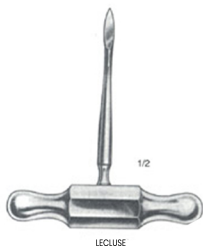
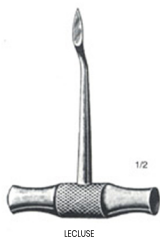

Root Elevators

Root Elevstors



WINTER
WI-040-200-WI-040-207



WINTER
WI-040-200
I-L



WINTER
WI-040-201
I-R



WINTER
WI-040-202
II-L



WINTER
WI-040-203
II-R



WINTER
WI-040-204
I2-L



WINTER
WI-040-205
I2-R



WINTER
WI-040-206
I4-L



WINTER
WI-040-207
I4-R

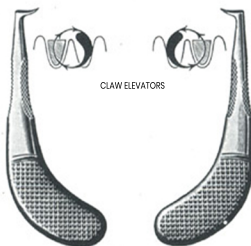

CLAW ELEVATORS

KARLLENHEBER

WI-040-208 14 mm
WI-040-208 10 mm

WI-040-210
WI-040-211

Root Elevators

Root Elevators



Root Elevators

Root Elevators



WI-042-020
90



WI-042-021
91



WI-042-022



WI-042-023



WI-042-024



READ
WI-042-025



READ
WI-042-026



GABKA
WI-042-027



GABKA
WI-042-028



COLEMAN
WI-042-029



LONDON-HOSPITAL-COLEMAN
WI-042-030
21



WI-042-031
22

Explorers & Scalars

Double-Ended Explorers



WI-043-001



WI-043-002



WI-043-003



WI-043-004



WI-043-005



WI-043-006



WI-043-007



WI-043-008



WI-043-009



WI-043-010



WI-043-011



WI-043-012



WI-043-013



WI-043-014



WI-043-015



WI-043-016



WI-043-017



WI-043-018



WI-043-019

Explorers & Scalers

Double-Ended Explorers

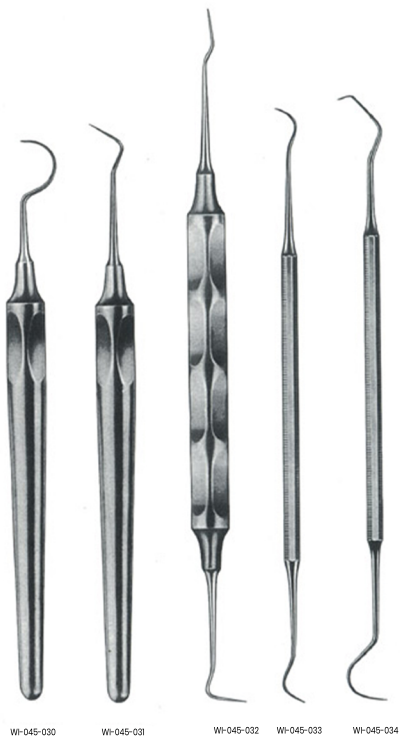

Explorers & Scalers

Double-Ended Explorers

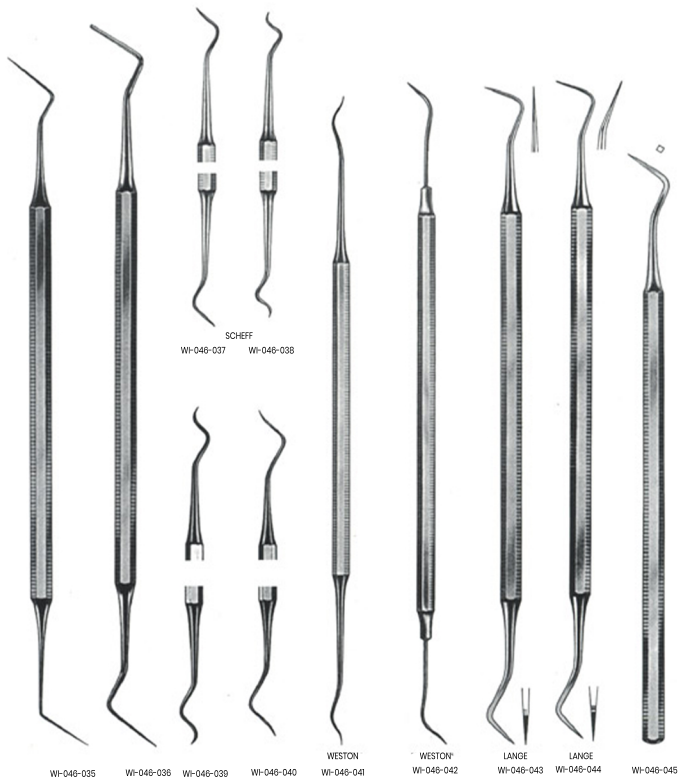

Explorers & Scalars

Scalers



STANDARD



WI-047-001
1



WI-047-002
2



WI-047-003
3



WI-047-004
4



WI-047-005
6



WI-047-006
7



WI-047-007
32



WI-047-008
33



WI-047-009
34



WI-047-010
33%



WI-047-011
34%



WI-047-012*
33A



WI-047-013
34A



WHITESIDE
WI-047-014
1



WI-047-015
2



ABOTT
WI-047-016
1



WI-047-017
2



ABOTT
WI-047-018
3



WI-047-019
4



CLEVELAND
WI-047-020
15



WI-047-021
1



DARBY-PERRY
WI-047-022
2



WI-047-023
5



DARBY-PERRY
WI-047-024
6



WI-047-025
11



WHITTEN
WI-047-026



WI-047-027
1



WHITE
WI-047-028
2



WHITE
WI-047-029
3



WI-047-030
4



MOORE

WI-048-031



WI-048-032



ZERFING

WI-048-033



GUY

WI-048-034

WI-048-035
2



WI-048-036
3



GUY

WI-048-037
4



WI-048-038
J1



JAQUETTE
WI-048-039
J2



WI-048-040
J3



SCHARMANN
WI-048-041
1



WI-048-042
2



SCHARMANN
WI-048-043
3



WI-048-044
4



SCHARMANN
WI-048-045
5



WI-048-046
6



SCHARMANN
WI-048-047
7



WI-048-048
8



HYGIENIST
WI-048-049
H5



HYGIENIST
WI-048-050
H6



WI-048-051
H7



HYGIENIST
WI-048-052
H8



WI-048-053
H9



WI-048-054
1



WI-048-055
2



WI-048-056
3



WI-048-057
4



WI-048-058
5



WI-048-059
6



WI-048-060
7



WI-048-061
8

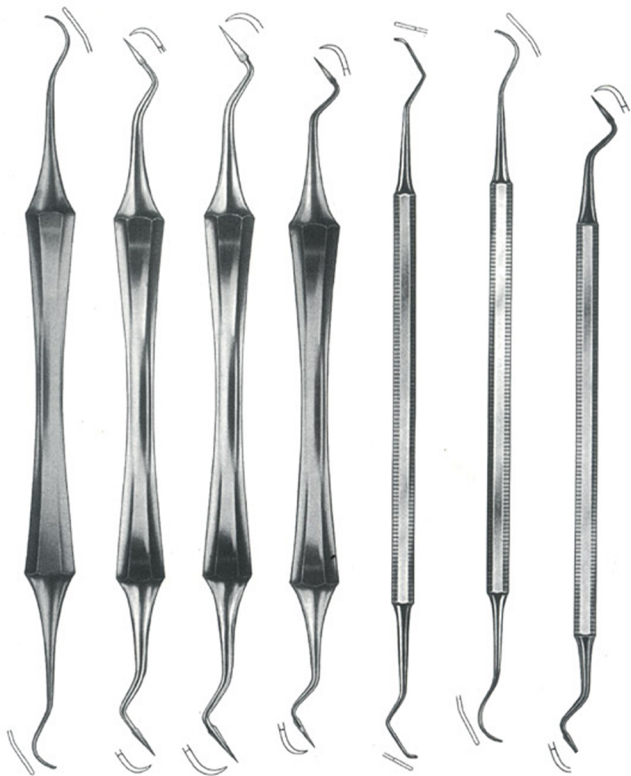

W-049-062

W-049-063

W-049-064

W-049-065

W-049-066

W-049-067

W-049-068

Explorers & Scalars

Mouth Mirrors

Simple Thread



Magnifying

Ø 20 mm
Ø 22 mm
Ø 24 mm
Ø 26 mm

WI-050-001
WI-050-002



Plane

WI-050-003
WI-050-004
WI-050-005
WI-050-006



Plane

WI0050-007

WI0050-008

With Cone-Socket



Magnifying

Ø 20 mm
Ø 22 mm
Ø 24 mm
Ø 26 mm

WI-050-009
WI-050-010



Plane

WI-050-011
WI-050-012
WI-050-013
WI-050-014



Plane

WI-050-015

WI-050-016

Wax Instruments, Knives & Spatulas Wax, Porcelain & Modelling Carvers



WI-051-001



WI-051-002



ZAHLE

WI-051-003

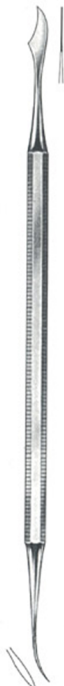

WI-051-004



WI-051-005



LE CRON

WI-051-006



WI-051-007

Wax Instruments, Knives & Spatulas Wax, Porcelain & Modelling Carvers

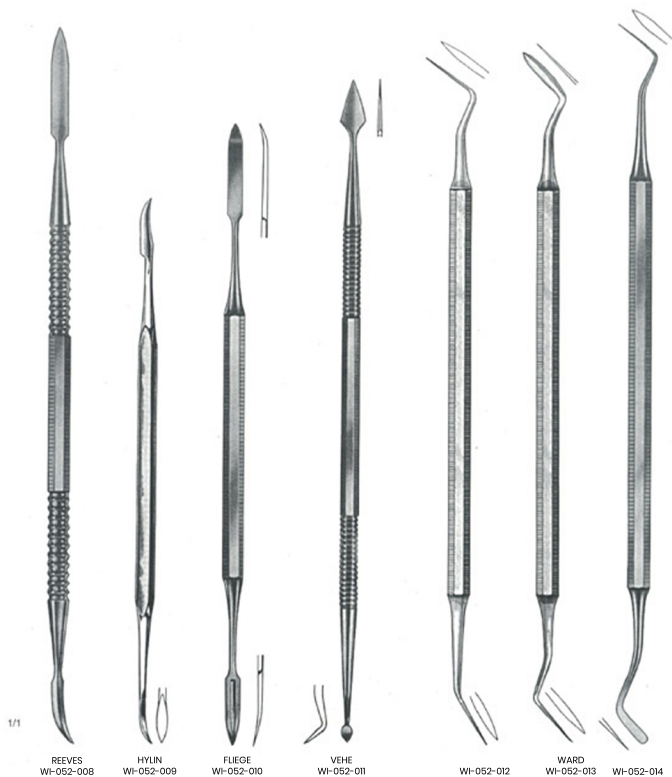

Wax Instruments, Knives & Spatulas Wax, Porcelain & Modelling Carvers

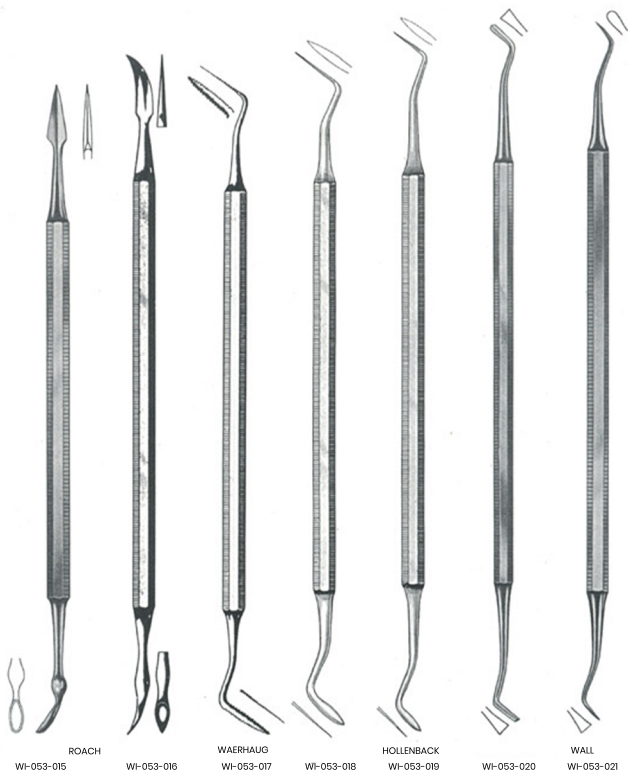

ROACH

WI-053-015

WI-053-016

WAERHAUG

WI-053-017

WI-053-018

HOLLENBACK

WI-053-019

WI-053-020

WALL

WI-053-021

Wax Instruments, Knives & Spatulas Wax, Porcelain & Modelling Carvers



Wax Instruments, Knives & Spatulas Wax, Porcelain & Modelling Carvers



WI-055-030



WI-055-031



WI-055-032



WI-055-033



WI-055-034
1



FRAHM
WI-055-035
2



WI-055-036
6

Wax Instruments, Knives & Spatulas Wax, Porcelain & Modelling Carvers

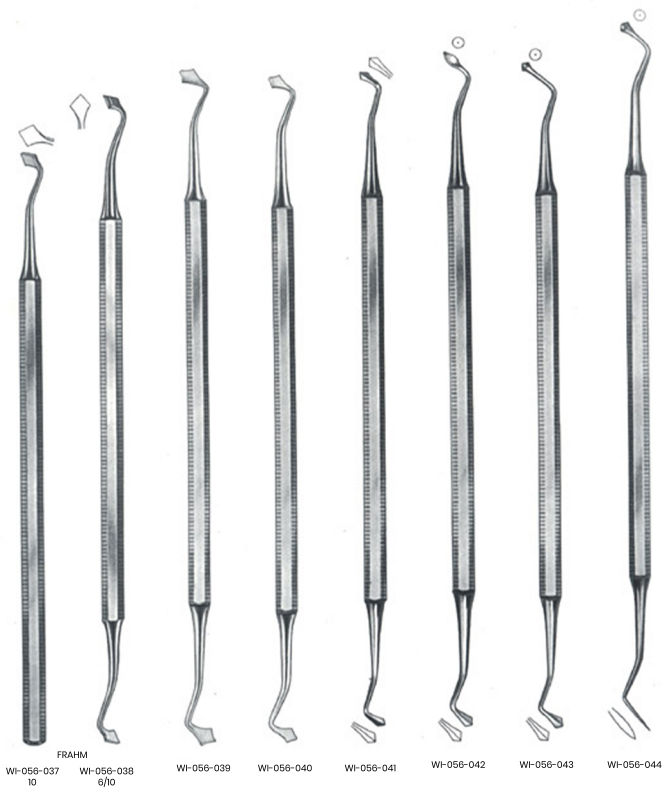

Wax Instruments, Knives & Spatulas Wax, Porcelain & Modelling Carvers



Wax Instruments, Knives & Spatulas Wax, Porcelain & Modelling Carvers



ERMERT

WI-058-054



WI-058-055



ANTKOVIA

WI-058-056



WI-058-057



1/1

WI-058-058



1/2

WI-058-059



1/2

WI-058-060



1/2

GRITMAN

WI-058-061

MIXING BOWL



WI-058-062
ca. 130 mm Ø



PLASTER CUTTING PLIER™
WI-058-063

Wax Instruments, Knives & Spatulas

Mixing Spatulas for Plaster & Alginates

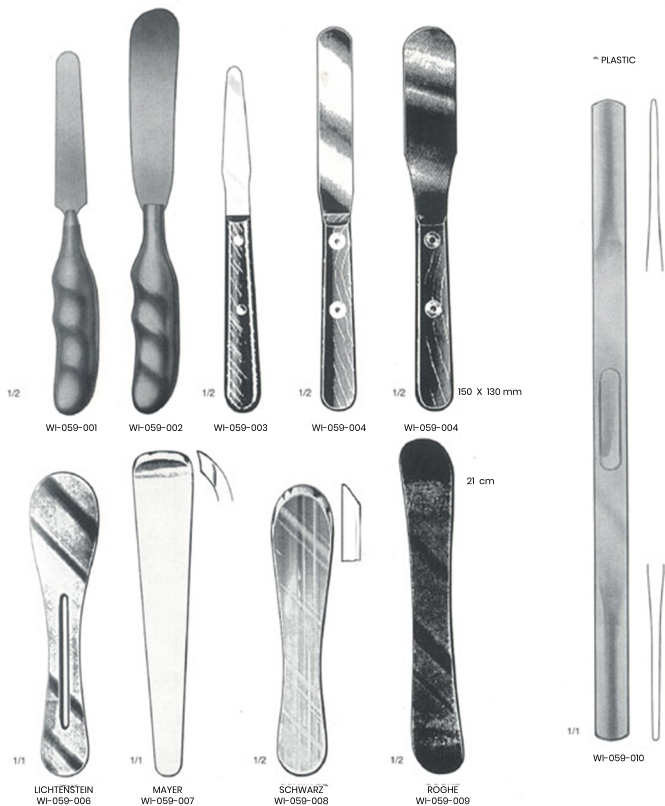

Dressing & Tissue Forceps

Dressing Forceps



Standard Pattern

WI-060-001	10.5 cm / 4"
WI-060-002	11.5 cm / 4½"
WI-060-003	13 cm / 5"
WI-060-004	14.5 cm / 4¾"
WI-060-005	16 cm / 6¼"



Standard Pattern fine

WI-060-006	11.5 cm / 4½"
WI-060-007	13 cm / 5"
WI-060-008	14.5 cm / 4¾"
WI-060-009	16 cm / 6¼"



Adson

WI-060-010	12cm / 4¾"
WI-060-011	15 cm / 6"



Micro Adson

WI-060-012	12cm / 4¾"
------------	------------



Semken

WI-060-013	12.5 cm / 5"
WI-060-014	15 cm / 6"



Iris - straight

WI-060-015	10 cm / 4"
------------	------------

Iris - curved

WI-060-016	10 cm / 4"
------------	------------

Dressing & Tissue Forceps Tissue Forceps



Standard Pattern 1 x 2 teeth
WI-061-001 10.5 cm / 4"
WI-061-002 11.5 cm / 4½"
WI-061-003 13 cm / 5"
WI-061-004 14.5 cm / 5½"
WI-061-005 16 cm / 6¼"



Standard Pattern
1 x 2 teeth fine pattern
WI-061-006 13 cm / 5"
WI-061-007 14.5 cm / 5½"
WI-061-008 16 cm / 6¼"



Semken 1 x 2 teeth
WI-061-009 12.5 cm / 5"
WI-061-010 15 cm / 6"



Adson 1 x 2 teeth
WI-061-011 12 cm / 4¾"
WI-061-012 15 cm / 6"



Micro Adson 1 x 2 teeth
WI-061-013 12 cm / 4¾"



Mayo Russian pattern
WI-061-014 23 cm / 9"

Dressing & Tissue Forceps

Dental Dressing Forceps



Meriam

WI-062-001	16 cm / 6 1/4"
WI-062-002	16 cm / 6 1/4"
WI-062-003	16 cm / 6 1/4"
WI-062-004	16 cm / 6 1/4"
WI-062-005	16 cm / 6 1/4"
WI-062-006	16 cm / 6 1/4"



WI-062-001



WI-062-002



WI-062-003



WI-062-004



WI-062-005



WI-062-006



London College

WI-062-007	15 cm / 6"
WI-062-008	15 cm / 6"
WI-062-009	15 cm / 6"
WI-062-010	15 cm / 6"
WI-062-011	15 cm / 6"
WI-062-012	15 cm / 6"



WI-062-007



WI-062-008



WI-062-009



WI-062-010



WI-062-011



WI-062-012

Dressing & Tissue Forceps Atraumatic Dissecting Forceps



DeBakey 1.5 mm
WI-063-013 16 cm / 6 ¼"
WI-063-014 20 cm / 8"



DeBakey 2.0 mm
WI-063-015 16 cm / 6 ¼"
WI-063-016 20 cm / 8"



DeBakey 2.0 mm / angled
WI-063-017 16 cm / 6 ¼"
WI-063-018 20 cm / 8"



DeBakey 2.7 mm
WI-063-019 16 cm / 6 ¼"
WI-063-020 20 cm / 8"



DeBakey 3.5 mm
WI-063-021 16 cm / 6 ¼"
WI-063-022 20 cm / 8"

Dressing and Tissue Forceps (Gold Plated)



Potts-Smith
WI-063-023 15 cm / 6"
WI-063-024 15 cm / 7"
WI-063-025 15 cm / 8"



Cushing
WI-063-026 17.5 cm / 7"
Cushing angled
WI-063-027 17.5 cm / 7"



Adson
WI-063-028 12 cm / 4 ¾"
WI-063-029 15 cm / 6"
Adson 1 x 2 teeth
WI-063-030 12 cm / 4 ¾"
WI-063-031 15 cm / 6"



Ohler 1 x 2 teeth
WI-063-032 14 cm / 5 ½"
WI-063-033 16 cm / 6 ¼"

Dressing & Tissue Forceps

Fine Surgical Scissors, Surgical Scissors



Straight blunt / blunt

WI-064-001	11.5 cm / 4 1/2"
WI-064-002	13.5 / 5"
WI-064-003	14.5 cm / 5 3/4"
WI-064-004	16.5 cm / 6 1/4"

Curved blunt / blunt

WI-064-005	11.5 cm / 4 1/2"
WI-064-006	13.5 / 5"
WI-064-007	14.5 cm / 5 3/4"
WI-064-008	16.5 cm / 6 1/4"



Straight sharp / blunt

WI-064-009	11.5 cm / 4 1/2"
WI-064-010	13.5 / 5"
WI-064-011	14.5 cm / 5 3/4"
WI-064-012	16.5 cm / 6 1/4"

Curved sharp / blunt

WI-064-013	11.5 cm / 4 1/2"
WI-064-014	13.5 / 5"
WI-064-015	14.5 cm / 5 3/4"
WI-064-016	16.5 cm / 6 1/4"



Straight sharp / blunt

WI-064-017	11.5 cm / 4 1/2"
WI-064-018	13.5 / 5"
WI-064-019	14.5 cm / 5 3/4"
WI-064-020	16.5 cm / 6 1/4"

Curved sharp / blunt

WI-064-021	11.5 cm / 4 1/2"
WI-064-022	13.5 / 5"
WI-064-023	14.5 cm / 5 3/4"
WI-064-024	16.5 cm / 6 1/4"



Iris - straight	
WI-064-025	10.5 cm / 4 1/8"
WI-064-026	11.5 cm / 4 1/2"

Iris - curved	
WI-064-027	10.5 cm / 4 1/8"
WI-064-028	11.5 cm / 4 1/2"



Iris angled on side	
WI-064-029	11.5 cm / 4 1/2"



Iris angled on side	
WI-064-030	11.5 cm / 4 1/2"



Joseph- straight	
WI-064-031	14 cm / 4 1/2"

Joseph- curved	
WI-064-032	14 cm / 4 1/2"



Kelly- straight	
WI-064-033	16 cm / 6 1/2"

Kelly- curved	
WI-064-034	16 cm / 6 1/2"

Scissors

Dissecting Scissors



Metzenbaum - straight
WI-065-035 14.5 cm / 5 1/4"
WI-065-036 18 cm 7"

Metzenbaum - curved
WI-065-037 14.5 cm / 5 1/4"
WI-065-038 18 cm 7"

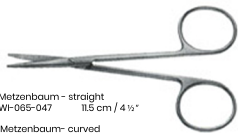

Metzenbaum - straight
WI-065-047 11.5 cm / 4 1/2"

Metzenbaum - curved
WI-065-048 11.5 cm / 4 1/2"

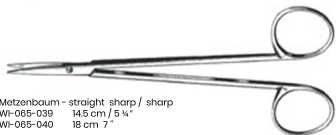

Metzenbaum - straight sharp / sharp
WI-065-039 14.5 cm / 5 1/4"
WI-065-040 18 cm 7"

Metzenbaum - curved sharp / sharp
WI-065-041 14.5 cm / 5 1/4"
WI-065-042 18 cm 7"

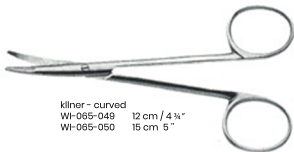

kilner - curved
WI-065-049 12 cm / 4 3/4"
WI-065-050 15 cm 5"



Metzenbaum - straight fine pattern
WI-065-043 14.5 cm / 5 1/4"
WI-065-044 18 cm 7"

Metzenbaum - curved fine pattern
WI-065-045 14.5 cm / 5 1/4"
WI-065-046 18 cm 7"

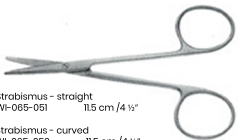

Strabismus - straight
WI-065-051 11.5 cm / 4 1/2"

Strabismus - curved
WI-065-052 11.5 cm / 4 1/2"

Scissors

Gum Scissors, Ligature Scissors, Wire Cutting Scissors, Crown Scissors, Dissecting Scissors



Very fine Dissecting Scissors straight
WI-066-053 11.5 cm / 4 1/2"

Very fine Dissecting Scissors curved
WI-066-054 11.5 cm / 4 1/2"



Lexer - Baby - straight
WI-066-055 10 cm / 4"

Lexer - Baby - curved
WI-066-056 10 cm / 4"

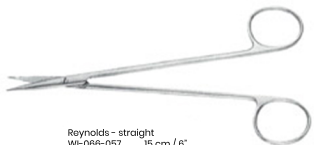

Reynolds - straight
WI-066-057 15 cm / 6"

Reynolds - curved
WI-066-058 15 cm / 6"



Gum Scissors straight serrated
WI-066-059 13 cm / 5"

Gum Scissors curved serrated
WI-066-060 13 cm / 5"



Spencer Ligature Scissors
WI-066-061 9 cm / 3 1/2"
WI-066-062 13 cm / 5"



Littauer Ligature Scissors
WI-066-063 14 cm / 5 1/2"



Universal Wire Cutting Scissors serrated
WI-066-064 12 cm / 4 1/4"



Beebee Crown Scissors straight smooth
WI-066-065 10 cm / 4"

Beebee Crown Scissors curved smooth
WI-066-066 10 cm / 4"

Tungsten - Carbide Scissors T/C Scissors (Gold Plated)

- * Welded tungsten-carbide blades
- * vacuum-hardened
- * long-lasting cut through latest finishing know-how



Standard
sharp/blunt, straight
14.5 cm / 5 3/4"
WI-067-001

Curved
14.5 cm / 5 3/4"
WI-067-002

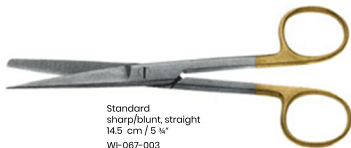

Standard
sharp/blunt, straight
14.5 cm / 5 3/4"
WI-067-003

Curved
14.5 cm / 5 3/4"
WI-067-004



Standard
sharp/sharp, straight
14.5 cm / 5 3/4"
WI-067-005

Curved
14.5 cm / 5 3/4"
WI-067-006

Tungsten - Carbide Scissors Dissecting Scissors



Mayo

straight	14.5 cm / 5 3/4"
WI-068-007	14 cm / 6 1/4"
WI-068-008	23 cm / 9"
WI-068-009	
curved	14.5 cm / 5 3/4"
WI-068-010	14 cm / 6 1/4"
WI-068-011	23 cm / 9"
WI-068-012	
straight - serrated	17 cm / 6 3/4"
WI-068-013	
curved - serrated	17 cm / 6 3/4"
WI-068-014	



Lexer

straight	16 cm / 6 1/4"
WI-068-015	
curved	16 cm / 6 1/4"
WI-068-016	
curved - serrated	16 cm / 6 1/4"
WI-068-017	



Mayo-Stille

straight	15 cm / 6"
WI-067-018	16 cm / 6 1/4"
WI-067-019	17 cm / 6 1/4"
WI-067-020	
curved	15 cm / 6"
WI-067-021	16 cm / 6 1/4"
WI-067-022	17 cm / 6 1/4"
WI-067-023	
straight - serrated	17 cm / 6 3/4"
WI-067-024	
curved - serrated	17 cm / 6 3/4"
WI-067-025	

METZENBAUM

blunt/blunt, straight

WI-068-026	18 cm / 7"
WI-068-027	20 cm / 8"
WI-068-028	23 cm / 9"
WI-068-029	25 cm / 10"

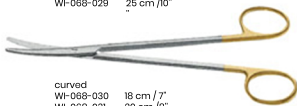

curved

WI-068-030	18 cm / 7"
WI-068-031	20 cm / 8"
WI-068-032	23 cm / 9"
WI-068-033	25 cm / 10"
WI-068-034	28 cm / 11"
WI-068-035	30 cm / 12"

curved - serrated

WI-068-036	18 cm / 7"
------------	------------

METZENBAUM-FINE PATTERN

blunt/blunt, straight

WI-068-037	14.5 cm / 5 3/4"
WI-068-038	18 cm / 7"
WI-068-039	20 cm / 8"
WI-068-040	23 cm / 9"



curved

WI-068-041	14.5 cm / 5 3/4"
WI-068-042	18 cm / 7"
WI-068-043	20 cm / 8"
WI-068-044	23 cm / 9"
WI-068-045	25 cm / 10"

METZENBAUM-FINE PATTERN

sharp/sharp, straight

WI-068-046	14.5 cm / 5 3/4"
WI-068-047	18 cm / 7"



curved

WI-068-048	14.5 cm / 5 3/4"
WI-068-049	18 cm / 7"

Tungsten - Carbide Scissors Dissecting Scissors



METZENBAUM
straight
WI-069-050 11.5 cm 4 1/2"
WI-069-051 11.5 cm 5 3/4"

curved
WI-069-052 11.5 cm 4 1/2"
WI-069-053 14.5 cm 5 3/4"

curved - serrated
WI-069-054 14.5 cm 5 3/4"



Ragnel
curved - serrated
WI-069-055 11.5 cm 4 1/2"



METZENBAUM - LAHEY
straight
WI-069-056 14.5 cm 5 3/4"

curved
WI-069-057 14.5 cm 5 3/4"



TOENNIS - ADSON
CURVED
WI-069-058 17 cm 6 3/4"



METZENBAUM
strong curve
WI-069-059 20 cm 8"
WI-069-060 23 cm 9"
WI-069-061 28 cm 11"



Parametrium scissors
light curve 23 cm / 9"
strong curve 22 cm 8 1/4"
WI-069-062
WI-069-063



WI-069-062



WI-069-063



Waldmann
episiotomy scissor
WI-069-064 20 cm 8"

Tungsten - Carbide Scissors

Fine Scissors, Wire Cutting Scissors,
Angled Scissors, Tenotomy Scissors



Kelly
straight
WI-070-065 16 cm 6 1/4"

curved
WI-070-066 16 cm 6 1/4"



Locklin
straight, handles, serrated
WI-070-070 16cm 4 1/4"



Iris
sharp/sharp, straight
WI-070-067 11.5 cm 4 1/2"

curved
WI-070-068 11.5 cm 4 1/2"



Locklin
straight, handles, serrated
WI-070-071 16cm 4 1/4"



Universal
Wire cutting scissor, serrated
WI-070-069 12.5 cm 5"

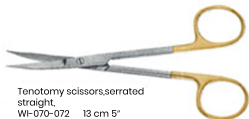

Tenotomy scissors, serrated
straight,
WI-070-072 13 cm 5"

curved
WI-070-073 13 cm 5"

Needle Holders Needle Holders



Mathieu
WI-071-001 14 cm / 5 1/2"
WI-071-002 17 cm / 6 3/4"
WI-071-003 20 cm / 8"



Mathieu narrow jaw
WI-071-004 14 cm / 5 1/2"
WI-071-005 17 cm / 6 3/4"



Mathieu with interior ratchet
WI-071-004 17 cm / 6 3/4"
WI-071-005 20 cm / 8"



Derf
WI-072-008 12 cm 4 1/4"



Hegar-Baumgartner
WI-072-009 14 cm 5 1/2"

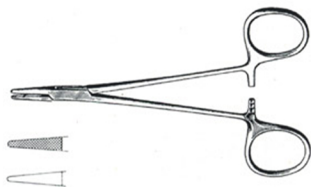

Halsey-serrated
WI-072-010 13 cm 5"

Halsey-smooth
WI-072-011 13 cm 5"

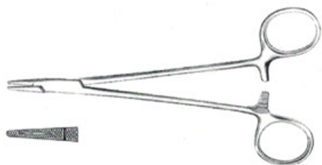

Crite-Wood
Wi-073-012 15 cm / 6"
Wi-073-013 18 cm / 7"

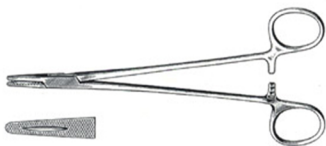

Mayo-Hegar
Wi-073-014 14 cm / 5 1/2"
Wi-073-015 16 cm / 6 1/4"
Wi-073-016 18 cm / 7"



Oison-Hegar
Wi-073-017 14 cm / 5 1/2"
Wi-073-018 18 cm / 7"



Gillies
Wi-073-019 16 cm / 6 1/4"

Tungsten - Carbide Needle Holders Needle Holders



WELDON has equipped the GOLD PLATED needle holders with different tungsten-carbide inserts according to their surgical indication:

1. smooth
2. PO2 = Pitch 02 = 0.2 mm distance
3. PO4 = Pitch 04 = 0.4 mm distance
4. PO5 = Pitch 05 = 0.5 mm distance

between pyramidal teeth

insert PO2- 05 are ground for vise-like and reliable stability of the needle while in use



Tungsten - Carbide Needle Holders

Micro Needle Holders

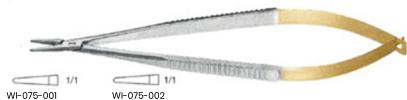

Castroviejo
smooth- without black

straight
WI-075-001 14 cm 5 1/2"
WI-075-002 18 cm 7"

curved
WI-075-003 14 cm 5 1/2"
WI-075-004 18 cm 7"



Castroviejo
smooth- with lock

straight
WI-075-005 14 cm 5 1/2"
WI-075-006 18 cm 7"

curved
WI-075-007 14 cm 5 1/2"
WI-075-008 18 cm 7"

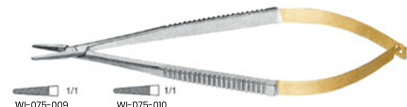

Castroviejo
Serrated P 02 without lock

straight
WI-075-009 14 cm 5 1/2"
WI-075-010 18 cm 7"

curved
WI-075-011 14 cm 5 1/2"
WI-075-012 18 cm 7"



Castroviejo
Serrated P 02 with lock

straight
WI-075-013 14 cm 5 1/2"
WI-075-014 18 cm 7"

curved
WI-075-015 14 cm 5 1/2"
WI-075-016 18 cm 7"

Tungsten - Carbide Needle Holders

Needle Holders



Halsey
serated
WI-076-017 13 cm / 5"

smooth
WI-076-018 13 cm / 5"



WI-076-017



WI-076-018



Hegar - Baumgartner
serated P04
WI-076-019 13 cm / 5"
WI-076-020 14 cm / 5 1/2"



WI-076-019



WI-076-020



Webster
smooth
WI-076-021 13 cm / 5"



WI-076-021

Tungsten - Carbide Needle Holders Needle Holders



Derf
serrated PO4
WI-077-022 12 cm / 4 1/4"



Mayo-Hegar
serrated PO5
WI-077-023 16 cm / 6 1/8"
WI-077-024 18 cm / 7"
WI-077-025 20 cm / 8"
WI-077-026 24 cm / 9 1/2"
WI-077-027 26 cm / 10 1/4"



Crile-Wood
serrated PO4
WI-077-028 15 cm / 6"
WI-077-029 18 cm / 7"
WI-077-030 20 cm / 8"



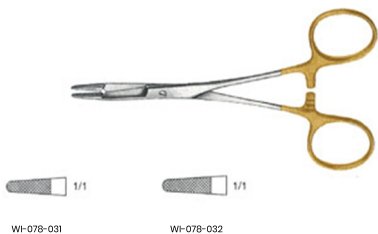

Olsen-Heger
serrated PO4
WI-078-031 14 cm / 5 1/2"
WI-078-032 18 cm / 7"

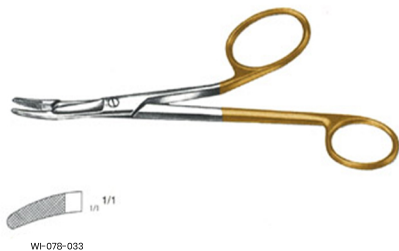

Gillies
serrated PO4
WI-078-033 16 cm / 6 1/4"

Tungsten - Carbide Needle Holders

Needle Holders



Mathieu
interior ratchet serated PO5
WI-079-034 17 cm / 6 3/4"
WI-079-035 20 cm / 8"



WI-079-034



WI-079-035



Mathieu
narrow jaw serated PO5
WI-079-036 14 cm / 5 1/2"
WI-079-037 17 cm / 6 3/4"



WI-079-036



WI-079-037



Mathieu
narrow jaw serated PO5
WI-079-038 14 cm / 5 1/2"
WI-079-039 17 cm / 6 3/4"
WI-079-040 20 cm / 8"



WI-079-038



WI-079-039



WI-079-040

V.P. Handes Scalpel Handles



3
WI-080-001



4
WI-080-002



7
WI-080-003



3 L
WI-080-004



4 L
WI-080-005

Suction Tubes

Suction Tubes



Yankauer 27 cm /11"
WI-081-001 complete consisting of:
WI-081-002 Suction head, detachable
WI-081-003 separate Olive
WI-081-004 suction tube only



Frazier 19 cm /17 1/2"
WI-081-005 Ø 5 Fr.
WI-081-006 Ø 8 Fr.
WI-081-007 Ø 10 Fr.
WI-081-008 Ø 12 Fr.



Adson 21 cm /8 1/2"
WI-081-009 Ø 4mm



Guthrie small retractors sharp 16 cm / 6 1/4"
 WI-082-001 - 2 prongs
 WI-082-002 - 2 prongs



WI-082-001

WI-082-002



Small retractors blunt 16 cm / 6 1/4"
 WI-082-003 - 1 prong
 WI-082-004 - 2 prongs
 WI-082-005 - 3 prongs
 WI-082-006 - 4 prongs



blunt

WI-082-003

WI-082-004

WI-082-005

WI-082-006



Small retractors blunt 16 cm / 6 1/4"
 WI-082-007 - 1 prong
 WI-082-008 - 2 prongs
 WI-082-009 - 3 prongs
 WI-082-010 - 4 prongs



sharp

WI-082-007

WI-082-008

WI-082-009

WI-082-010



Small retractors blunt flexible 16 cm / 6 1/4"
 WI-083-011 - 2 prongs
 WI-083-012 - 3 prongs
 WI-083-013 - 4 prongs

Blunt



WI-083-013



WI-083-012



WI-083-013

sharp



WI-083-014



WI-083-015



WI-083-016

Small retractors sharp flexible 16 cm / 6 1/4"
 WI-083-014 - 2 prongs
 WI-083-015 - 3 prongs
 WI-083-016 - 4 prongs



O'Conner small retractor sharp 16 cm / 6 1/4"
 WI-083-017 - 1 prong



Desmarres 16 cm / 6 1/4"
 WI-083-018 8 mm wide
 WI-083-019 10 mm wide
 WI-083-020 12 mm wide
 WI-083-021 14 mm wide
 WI-083-022 16 mm wide
 WI-083-023 18 mm wide



Hemingway
Curettes



WI-084-001 # 1



WI-084-002 # 2



WI-084-003 # 3



WI-084-004 # 4



Lucas
Curettes



WI-084-005 # 1



WI-084-006 # 2



WI-084-007 # 3



WI-084-008 # 4

Mouth Gags & Tongue Depressors

Mouth Gags, Tongue Depressors



Denhart
WI-085-001 12 cm / 4 1/4"



Jennings
WI-085-002 14.5 cm / 4 1/2"
WI-085-004 14.5 cm / 4 1/4"
WI-085-004 14.5 cm 5"
WI-085-005 14.5 cm 6"



Tobold
WI-085-008 14.5 cm 4 1/2"

Mouth Gags & Tongue Depressors Tongue Depressors, Tongue Forceps



Wieder
WI-086-007 14 cm 5 1/2"
WI-086-008 15 cm 6"



Brunings
WI-086-009 19 cm 7 1/2"



Cawood
WI-086-010 15.5 cm 6"



Collin
WI-086-011 17 cm 6 3/4"

Bone Files

Periosteal Raspatories & Elevators, Bone & Alveolotomy Files



Molt
Raspatory
WI-087-002 19 cm 7 1/2"



Willinger
Raspatory
WI-087-002 13 cm 5"



Willinger
Raspatory
WI-087-003 16 cm 6 1/4"



Willinger
Elevator
WI-087-004 16 cm 6 1/4"



Willinger
Elevator
WI-087-005 17 cm 6 3/4"



Seldin
Elevator
WI-087-006 #22



Seldin
Elevator
WI-087-007 #23



Seldin File
WI-087-008 #11



Seldin File
WI-087-009 #12

Bone Files

Bone & Alveolotomy Files



Miller
straight cut



WI-088-010 #1



WI-088-011 #2



WI-088-012 #3



WI-088-013 #4



Miller
cross cut



WI-088-014 #1



WI-088-015 #2



WI-088-016 #3

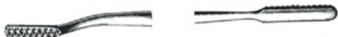

WI-088-017 #4

Rubber Dam Punches & Separators

Rubberdam Instruments

Rubberdam punch



Ainsworth
WI-089-001 5 Holes
WI-089-002 6 Holes
17 cm



Ainsworth
WI-089-003



Ivory
WI-089-004
16 cm

Rubberdam Clamp Forceps



1/2

WI-089-005



1/2

WI-089-006

Matrix Retainers / Separators

Matrix Bands



Ivory
WI-090-001
14



Elliot
WI-090-002
16



Ivory
WI-090-003
without shields
1



Ivory
WI-090-004
with shields
12



With Shield and Lock

Ivory
WI-090-005
12A

molar



WI-090-006
WI-090-007
WI-090-008

Packing unit per fig. 12 pc.



WI-090-009
WI-090-010
WI-090-011

Premolars

Matrix Retainers / Bands

Matrix Retainers



TOFFLEMIRE - UNIVERSAL
WI-09I-012



TOFFLEMIRE - SENIOR
WI-09I-013



TOFFLEMIRE - JUNIOR
WI-09I-014

With Matrix Brands
WI-09I-012A



WI-09I-015



WI-09I-016



WI-09I-017

PACKING UNIT PER FIG. 12 PC.

WI-09I-015A
ONE DOZEN ASSORTED

Matrix Retainers / Bands

Matrix Bands



WI-092-018 5mm
WI-092-019 6mm
WI-092-020 7mm



Ivory
WI-092-021



Adjustable

Didner
WI-092-022



Nystrom
WI-092-023

For Molars and Premolars



WI-092-024



WI-092-028



WI-092-025



WI-092-029



WI-092-026



WI-092-030



WI-092-027

For Matrix Retainers

WI-092-018/19/20
WI-092-021
WI-092-022



MERSON
WI-093-001

BAND PUSHER



MERSON-YOUNG
WI-093-002



MERSON-YOUNG
WI-093-003



WI-093-004



WI-093-005



WI-093-006

BAND SETTER

Crown Trial Forceps for Ceramical Crowns



WI-094-012

1 PAIR PLASTIC INSERTS



STEINER
 WI-094-007



SACHS
 WI-094-008



MILLER
 WI-094-009
 ARTICULATING PAPER FORCEPS



WI-094-010



WI-094-011

WITH ANATOMICAL HANDLE
 WI-094-010A WI-094-011A

CROWN PLIERS

- * Ergonomic design with cranked jaws for assured grip
- * Jaw configuration provides circular aperture
- * Grips crowns and bridges securely regardless of material
- * Cannot damage the tooth neck area
- * Crown Forceps can be used for a variety of application, e.g.
 - *To insert and remove temporary dressings
 - *To **dit tight-fitting crowns**
 - *To grip remove superficial root remnants, specially in the treatment of children
 - *As an exceptionally usefull aid in the hands of the dentist's assistant



WI-095-001



WI-095-020

PLIER FOR THE EXTRACTION OD CROWNS

- *Take off crowns and bridges in the area of the upper and lower jaws during the intraoral trial
- *The advantages of this plier are evident, as one model only is sufficient instead of the different pliers one had until now for the upper and lower jaws.
- *The **exchangeable elastic insert prevents damage to the crown surface**
- *the beaks submitted to wear can be exchanges and are sterilizable upto 180C

Crown Removers

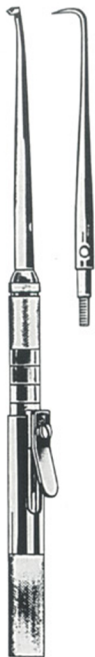

S.U. CROWN BUTLER
 WI-096-003



WI-096-004 WI-096-005 WI-096-006 WI-096-007

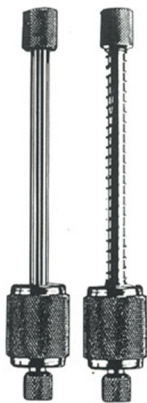

MILLER
 WI-096-008 WI-096-009



TREYMAN
 WI-096-010

CAOMPLETE WITH 3 ATTACHMENT

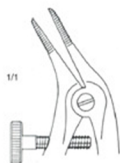

a	b	c	d
3.3	4	2.3	3 mm
4.4	5	3.4	3.8 mm



Bohm

WI-097-011 12 cm
WI-097-012 15 cm



1/2

Bohm

WI-097-013
WI-097-014



1/2

WI-097-015

Syringes

Cartridge Syringes

1/2

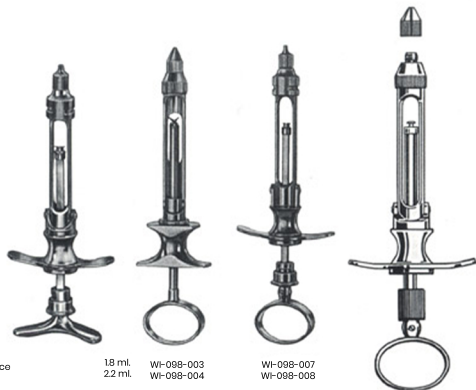

With Aspiration Device

1.8 ml.
2.2 ml.

WI-098-003
WI-098-004

WI-098-007
WI-098-008

Without Aspiration

WI-098-001 1.8 ml.
WI-098-002 2.2 ml.

WI-098-005
WI-098-006

WI-098-009 1.8ml.

With Aspiration Device



WI-098-010



WI-098-011

Mod. EHRICKE



1/2

Sup F (BO)

	Fig.
WI-099-001	0
WI-099-002	1
WI-099-003	2
WI-099-004	3
WI-099-005	4

Toothed Upper Jaws, perforated



Sup P (PO)

	Fig.
WI-099-006	1
WI-099-007	2
WI-099-008	3

Partially Toothed Upper Jaws, Perforated



Sup F (FO)

	Fig.
WI-099-009	1
WI-099-010	2
WI-099-011	3

Functional Impression Upper perforated



Sup U (UO)

	Fig.
WI-099-012	1
WI-099-013	2
WI-099-014	3

Edentulous Upper perforated

Mod. EHRICKE



INF B (BU)	Fig
WI-100-015.	0
WI-100-016.	1
WI-100-017.	2
WI-100-018.	3
WI-100-019.	4

Toothed Lower Jaws, Perforated



INF P (PU)	Fig
WI-100-020.	1
WI-100-021	2
WI-100-022.	3

Partially Toothed Lower Jaws, Perforated



INF U (UU)	Fig
WI-100-023.	1
WI-100-024	2
WI-100-025	3

Edentulous Lower Jaws, Perforated

Mod. EHRICKE

1/2



Sup B (BC)	Fig.
WH-10I-026	0
WH-10I-027	1
WH-10I-028	2
WH-10I-029	3
WH-10I-030	4

Toothed Upper Jaws, Unperforated



Sup P (PC)	Fig.
WH-10I-031	1
WH-10I-032	2
WH-10I-033	3

Partially Toothed Upper Jaws, unperforated

1/2



Sup F (FO)	Fig.
WH-10I-034	1
WH-10I-035	2
WH-10I-036	3

Functional Impressions, Upper, unperforated

1/2



Sup U (UO)	Fig.
WH-10I-037	1
WH-10I-038	2
WH-10I-039	3

Edentulous Upper Jaws, Unperforated



INF B (BU)

	Fig
WH-102-040	0
WH-102-041	1
WH-102-042	2
WH-102-043	3
WH-102-044	4

Toothed Lower Jaws, Unperforated



INF P (PU)

	Fig
WH-102-045	1
WH-102-046	2
WH-102-047	3

Partially Toothed Lower Jaws, Unperforated



INF U (UO)

	Fig
WH-102-048	1
WH-102-049	2
WH-102-050	3

Edentulous Lower Jaws, Unperforated

Hemostatic Hemostatic Forceps



Hartmann - straight
WH-103-001 10 cm / 4"

Hartmann - curved
WH-103-002 10 cm / 4"



Hollstoad-Mosquito - straight
WH-103-003 12.5 cm / 5"

Hollstoad-Mosquito - curved
WH-103-004 12.5 cm / 5"

Hollstoad-Mosquito straight 1 x 2 teeth
WH-103-005 12.5 cm / 5"

Hollstoad-Mosquito curved 1 x 2 teeth
WH-103-006 12.5 cm / 5"



Micro-Mosquito - straight
WH-103-007 12 cm / 4 3/4"

Micro-Mosquito - curved
WH-103-008 12 cm / 4 3/4"

Micro-Mosquito straight 1 x 2 teeth
WH-103-009 12 cm / 4 3/4"

Micro-Mosquito curved 1 x 2 teeth
WH-103-010 12 cm / 4 3/4"

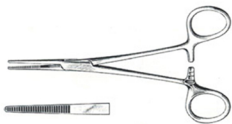

Kelly - straight
WH-103-011 14 cm / 5 1/2"

Kelly - curved
WH-103-012 14 cm / 5 1/2"



Friedman Rongeur - curved
WH-104-001 12 cm / 5" 30°
WH-104-002 14 cm / 5 1/2" 30°
WH-104-003 12 cm / 5" 45°



Cleveland Rongeur - curved
WH-104-004 14 cm / 5 1/2" 30°
WH-104-005 17 cm / 6 3/4" 30°



Mead Bone Rongeur - curved
WH-104-006 16.5 cm / 6 1/2" 30°



Blumenthal Rongeur - curved
WH-104-007 15 cm / 6" 30°
WH-104-008 15 cm / 6" 45°
WH-104-009 15 cm / 6" 90°



Luer Rongeur - short jaw
curved
WH-105-010 15 cm / 6" 25°

Luer Rongeur - narrow jaw - curved
WH-105-018 15 cm / 6" 45°

Luer Rongeur - wide jaw - curved
WH-105-022 15 cm / 6" 40°



Luer Rongeur - straight
WH-105-013 17 cm / 6 1/2"

curved
WH-105-014 17 cm / 6 1/2"



Bayer Rongeur - curved
WH-105-015 18 cm / 7"



Zaufal - Jansen Rongeur - curved
WH-105-016 18 cm / 7"

Bone Cutting Forceps

Bone Cutting Forceps



Cleveland Bone Cutting Forceps - curved
W-106-001 15 cm / 6"
W-106-002 17 cm / 6 3/4"



Liston Bone Cutting Forceps
straight
W-106-003 14 cm / 5 1/2"
W-106-004 17 cm / 6 3/4"
W-106-005 19 cm / 7 1/2"
W-106-006 22 cm / 8 1/2"

Liston Bone Cutting
curved
W-106-003 14 cm / 5 1/2"
W-106-004 17 cm / 6 3/4"
W-106-005 19 cm / 7 1/2"
W-106-006 22 cm / 8 1/2"



Ruskin Bone Cutting - straight
W-106-007 18 cm / 7"

Ruskin Bone Cutting
W-106-007B 18 cm / 7"



Cleveland Bone Cutting
W-106-009 18 cm / 6 1/4"

Pliers

Wire Cutting & Bending Pliers



Orthodontic Wire Cutter
W-107-001 (Gold Plated)



Hacklock Wire Bonding Plier
Longitudinal Groove in Jaw
W-107-002



Hacklock Wire Bonding Plier
Longitudinal Groove in Jaw
W-107-003

Pliers

Flate Nose Pliers

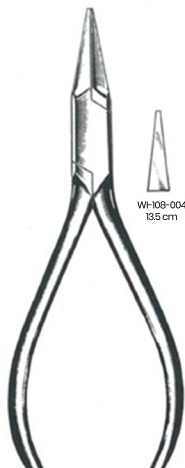

WI-108-004
13.5 cm



WI-108-005
13.5 cm



WI-108-006
13.5 cm



WI-108-007
13.5 cm



WI-108-008
13.5 cm



WI-108-009
13.5 cm



WI-108-010
13.5 cm



WI-108-011
13.5 cm



WI-108-012
14.5 cm



WI-108-013
14.5 cm



WI-108-014
14.5 cm



Splinter Forceps

Stieglitz
WI-108-015
13.5 cm



LANGBECK
15 cm



WI-108-016



WI-108-017



LANGBECK
15 cm



WI-108-018

Pliers

Flat Nose Pliers



WH-109-019
15 cm



WH-109-020
15 cm



15 cm



WH-109-021
13.5 cm



WH-109-022
13.5 cm



13.5 cm



13.5 cm



WH-109-023
13.5 cm



WH-109-024
13.5 cm



WH-109-025
13.5 cm



WH-109-026
13.5 cm



WH-109-027
13.5 cm

Flat Nose Pliers

Pliers

Flat Nose Pliers

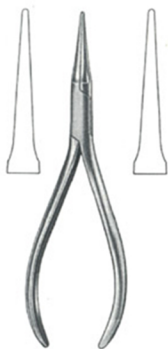

WI-110-028
16.5 cm



WI-110-029
14 cm

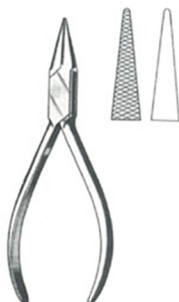

GOSLEE
WI-110-030
14 cm



WI-110-031
15 cm



WI-110-032
15 cm

Pliers

Round Nose Pliers



WI-III-033
14 cm



WI-III-034
14 cm

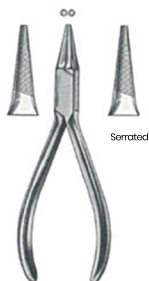

WI-III-035
14 cm



LANGBECK
WI-III-036
15 cm



WI-III-037
14.5 cm

Pliers

Wire Bending Pliers

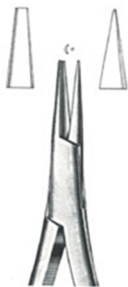

SCHWARZ I
WI-T12-038
14 cm



SCHWARZ II
WI-T12-039
14 cm

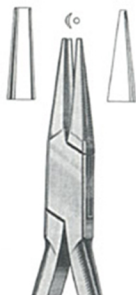

SCHWARZ III
WI-T12-040
14 cm



WI-T12-041
13 cm



FISCHER
WI-T12-042
14 cm



ANDERSEN
WI-T12-043
13,5 cm

Pliers

Wire Bending Pliers

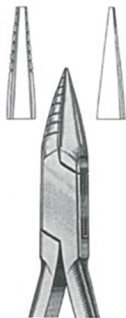

SCHWARZ
Wf-113-044
13.5 cm



McCELLOPS
16 cm



Wf-113-045

1



Wf-113-046

2



Wf-113-047

3

T/C Inserts

0.5 - 0.7 mm



ADAMS
Wf-113-048
12.5 cm

0.7 mm

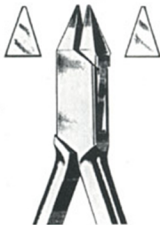

ADAMS
Wf-113-049
Wf-113-050
14.5 cm

0.9 mm



ADAMS
Wf-113-051
Wf-113-052
14.5 cm

Pliers

Wire Bending Pliers

T/C Inserts

0.5 - 0.7 mm



WI-T14-053
12.5 cm

0.5 - 0.7

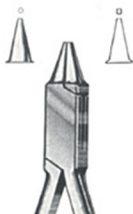

ANGLE
WI-T14-054
WI-T14-055
12.5 cm

0.7 mm

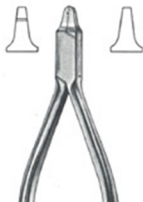

WI-T14-056

0.9 mm



ADERER
WI-T14-057
11.5 cm

0.9 cm



ADERER
WI-T14-058
12 cm



ADERER
WI-T14-059
16 cm



ADAMS
WI-T14-060
16 cm

Pliers

Wire Bending Pliers

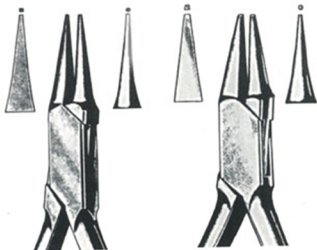

W-115-062
14 cm

W-115-063
13 cm

Contouring Pliers

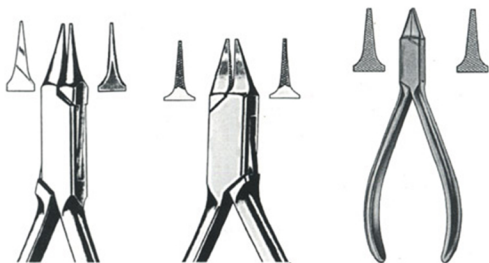

W-115-064
13 cm

FREVERT
W-115-065
13 cm

FREVERT
W-115-066
13 cm

Pliers

Collar Pliers



PEESO
WI-116-067
13 cm



PEESO
WI-116-088
13 cm



ROBINSON
WI-116-069
13 cm



WALDRON
WI-116-070
13 cm



OLIVER
WI-116-071
13 cm



LINDBLOM
WI-116-072
15 cm

Pliers

Crown Stretching Pliers



PEESO
WH-117-073
145 cm



PEESO
WH-117-074
145 cm



TRYFUS
WH-117-075
17 cm

Pliers

Ligature Pliers



HOW
WI-118-076
15 cm



HOW
WI-118-077
15 cm



FISCHER
WI-118-078
14.5 cm



WEINGART
WI-118-079
14 cm



KORKHAUS
WI-118-080
17 cm

Pliers

Band Removing Pliers



OLIVER
WI-119-081
15 cm



OLIVER
WI-119-082
15 cm



WI-119-083
15 cm
Straight

FURRER

WI-119-084
15 cm
Curved

Anterior Band Removing Pliers



WI-119-085
14 cm



ANGLE
WI-119-086 14.5 cm
WI-119-087 16 cm

Pliers

Band Removing Pliers

Crown Instruments



WI-120-088
15.5 cm



MONFORT
WI-120-089
17.5 cm

Wire and Clasp Bending Pliers

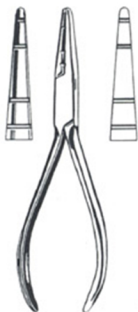

ADERER
WI-120-090
16 cm



ADERER
WI-120-091
16 cm



NANCE
WI-120-092
13.5 cm

Pliers

Loop & Arch Forming Pliers



JARABAC
WH-121-083
15 cm



TWEED
WH-121-084
14 cm



O'BRIEN
WH-121-095
14 cm

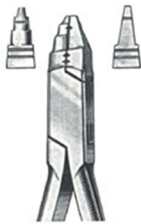

YOUNG
WH-121-096
14 cm

T/C Inserts



TWEED
WH-121-097
13 cm

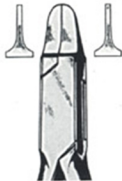

ANGLE
WH-121-088
WH-121-089
13 cm

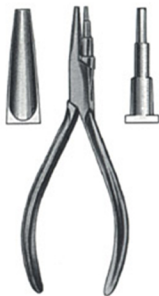

WH-121-100
15 cm

Pliers

Clasp Bending Pliers



ADERER
WH-122-101
14 cm

Arrow Head Clasp Forming Pliers



SCHWARZ
WH-122-102
12.5 cm

Arrow Head Clasp Bending Pliers



SCHWARZ
WH-122-103
13 cm

Arrow Clasp Former

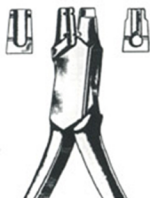

SCHWARZ
WH-122-104
14 cm



SCHWARZ
WH-122-105
14 cm

Arrow Clasp Bending Pliers



SCHWARZ
WH-122-106
14 cm

Arrow Clasp Former

Pliers Clasp Bending Pliers

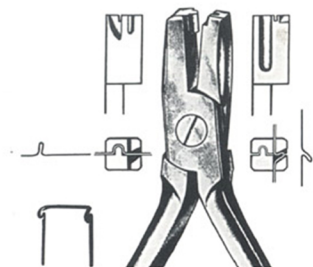

NANCE
WF-123-107
14 cm

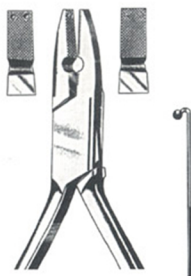

WF-123-108
13 cm



De La Rosa
WF-123-109
14 cm

Pliers

Contouring Pliers



UNIVERSAL
WH-124-110
15 cm



TRIPLEX
WH-124-111
14.5 cm



JOHNSON
WH-124-112
13.5 cm



ABELL
WH-124-113
13.5 cm

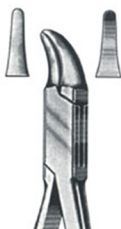

REYNOLDS
WH-124-114
13.5 cm



GORDON
WH-124-115
13.5 cm

Pliers

Clasp Bending Pliers

To be used as:

- 1 Pin and Ligature Plier
- 2-3 Clasp Bending Plier
- 4 Bar Bending Plier
- 5 Cutting Plier

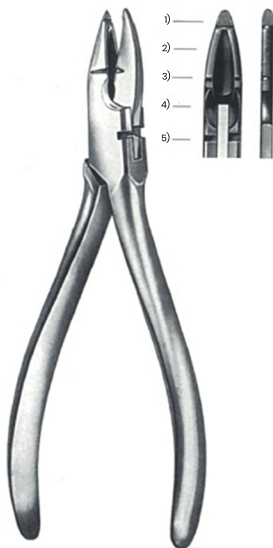

WADALSACHS-UNIVERSAL
WH-125-116
15 cm

Universal Pin Bending Pliers



UNIVERSAL
WH-125-117
15 cm

Pliers

Wire Cutting Pliers

Universal Pin Bending Plier

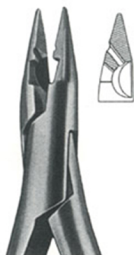

WI-126-118
15 cm

Side Nippers



WI-126-119
13 cm



ANGLE
WI-126-120
13 cm



WI-126-121
13 cm

Side Cutter of
Chrome-Vanadium-Steel



WI-126-122
125 cm

Side Cutters

Pliers

Wire Cutting Pliers

Side Cutters



WI-127-123 11 cm
WI-127-124 13 cm



WI-127-125 16 cm

End Nippers



WI-127-126 13 cm

End Cutters



WI-127-127 18.5 cm

End Nippers



WI-127-128 16 cm

Surgical Instruments Made Right :)

W **Weldon Industries** 
WELDON The Instruments Company

 +92 52 3562980 / 3255643
 waqar.weldonind@gmail.com
 www.weldonind.com

